

**PEDIATRIC HYDROXYUREA PHASE III CLINICAL TRIAL  
BABY HUG**

**MANUAL OF OPERATIONS**

**Prepared by:**

**Clinical Trials & Surveys Corp.  
Suite 350  
2 Hamill Road  
Baltimore, Maryland 21210**

**NOTICE:** The contents of this document are confidential and are not to be cited or discussed except with individuals to whom it has been distributed.

**PEDIATRIC PHASE III CLINICAL TRIAL OF HYDROXYUREA  
IN SICKLE CELL ANEMIA (BABY HUG)**

**MANUAL OF OPERATIONS**

**Table of Contents**

Chapter		Page
1	BACKGROUND AND STUDY RATIONALE	
1.1	Overview Sickle Cell Anemia	1-1
1.2	Chronic Organ Damage in Sickle Cell Anemia	1-2
	1.2.1 Spleen	1-2
	1.2.2 Kidneys	1-2
	1.2.3 Brain	1-3
	1.2.4 Lungs	1-4
1.3	Sickle Cell Anemia and Fetal Hemoglobin	1-4
	1.3.1 Fetal Hemoglobin	1-4
	1.3.2 Physiologic Decline of HbF	1-5
1.4	Efficacy of Hydroxyurea in Sickle Cell Anemia	1-6
	1.4.1 Induction of HbF	1-6
	1.4.2 Hydroxyurea for Adults with SCA	1-7
	1.4.3 Hydroxyurea for Children with SCA	1-7
	1.4.4 Hydroxyurea for Very Young Children with SCA	1-8
1.5	Toxicities of Hydroxyurea Therapy	1-9
	1.5.1 Organ Damage	1-9
	1.5.2 Neurodevelopmental Effects	1-10
	1.5.3 Mutagenic and Carcinogenic Potential	1-11
	1.5.4 Acquired DNA Mutations in Association with Hydroxyurea Therapy	1-13
1.6	Summary	1-14
	Figure 1-1	1-16

2	OBJECTIVES AND DESIGN OF THE TRIAL	
2.1	Introduction	2-1
2.2	Specific Aims	2-2
2.3	Design of the Trial	2-3
	2.3.1 Overview of the Trial	2-3
	2.3.2 The Feasibility and Safety Pilot Study	2-4
2.4	Endpoints	2-7
2.5	Safety Monitoring	2-8
	Figure 2-1	2-10
3	PATIENT ELIGIBILITY, RECRUITMENT, ORIENTATION, and INFORMED CONSENT	
3.1	Introduction	3-1
3.2	Recruitment	3-2
3.3	Parent/Guardian Orientation	3-2
3.4	Patient/Family Advocates	3-3
	3.4.1 Qualifications	3-4
	3.4.2 Responsibilities and Activities	3-4
3.5	Informed Consent	3-5
3.6	Eligibility Assessment	3-5
	3.6.1 Eligibility Screening I	3-6
	3.6.1.1 Inclusion Criteria	3-6
	3.6.1.2 Exclusion Criteria	3-6
	3.6.2 Eligibility Screening II	3-7
	3.6.2.1 Screening Tests	3-7
	3.6.2.2 Test Timeline	3-9
	3.6.3 MCC Review	3-9
4.	RANDOMIZATION AND ENROLLMENT OF PATIENTS	
4.1	Randomization Procedures	4-1
4.2	Practice Randomization for the ATRS	4-2
4.3	How to Resolve Problems with the ATRS	4-3
	Exhibit 4-1	4-5
	Exhibit 4-2	4-6

5	STUDY TREATMENTS	
5.1	Overview	5-1
5.2	Study Treatment Manufacturer	5-3
5.3	Pharmacy Distribution Center	5-3
5.4	Clinical Center Pharmacies	5-4
5.5	Treatment Preparation	5-6
5.6	Definitions of Toxicity	5-7
5.7	Monitoring for Toxicity	5-7
5.8	Dose Titration	5-9
	5.8.1 Hydroxyurea	5-9
	5.8.2 Placebo	5-10
5.9	Unblinding	5-10
5.10	Treatment Interruptions	5-13
5.11	Assessment of Compliance	5-13
5.12	Missed Visits and Drop-Outs	5-13
5.13	Duration of Study Treatment	5-14
5.14	Investigational New Drug	5-14
	Exhibit 5-1	5-15
	Exhibit 5-2	5-16
	Exhibit 5-3	5-17
	Exhibit 5-4	5-18
6	CLINICAL CENTER PROCEDURES	
6.1	Scheduling	6-1
	6.1.1 General Principles for Scheduling Baseline and Exit Tests	6-1
	6.1.2 Sample Schedule for Baseline Testing	6-2
	6.1.3 Study Treatment Initiation Visit	6-3
	6.1.4 Weekly and Monthly Visits	6-3
	6.1.5 Study Exit Visit at 24 Months	6-4
	Figure 6-1	6-7
6.2	Visit Schedule, Expectation, and Data Collection	6-8
	6.2.1 Visit Types and Numbering	6-8
	6.2.2 Schedule of Expected Visits	6-8
	6.2.3 Visit Windows	6-9

	6.2.3.1	Weekly Visits	6-9
	6.2.3.2	Monthly Visits	6-9
	6.2.4	Website Reports	6-9
	6.2.5	Forms Linked to the Visit Schedule	6-10
6.3		Maintenance of Study Records	6-12
	6.3.1	Patient Records	6-12
	6.3.1.1	Coordinator Files	6-12
	6.3.1.2	PEP Files	6-13
	6.3.2	Clinical Center Records	6-13
6.4		Transfer of BABY HUG Patients	6-14
	6.4.1	Notification of Transfer	6-14
	6.4.2	Release of Medical and Study Records	6-15
	6.4.3	Consenting the Patient at the New Clinical Center	6-16
	6.4.4	First Visit at the New Clinical Center	6-17
	6.4.5	Transfer of Study Treatment	6-17
	6.4.6	Additional Issues	6-18
6.5		Local CBC Guidelines	6-19
	6.5.1	Routine Study Visits	6-19
	6.5.1.1	Toxicities	6-20
	6.5.1.2	Alerts	6-20
	6.5.2	Unscheduled Study Visits	6-21
6.6		Adverse Events Monitoring	6-21
	6.6.1	Definitions	6-21
	6.6.2	Monitoring and Reporting Adverse Events	6-22
	6.6.3	Event Start and Stop Dates	6-25
	6.6.3.1	Serious Adverse Events	6-25
	6.6.3.2	Adverse Events	6-26
	6.6.4	Reporting Treatment, Management and Outcomes of AE/SAE	6-29
	6.6.5	Additional Severe Adverse Event and Unexpected Adverse Event Reporting	6-29
	6.6.5.1	Notifications	6-29
	6.6.5.2	Documentation	6-30
	Exhibit 6-1		6-32
	Exhibit 6-2		6-33

Exhibit 6-3		6-34
Exhibit 6-4		6-35
7	COLLECTION AND SHIPMENT OF SPECIMENS FOR CENTRAL LABORATORIES	
7.1	Overview	7-1
7.2	Labels	7-2
7.3	Shipping Transmittal Forms	7-2
7.4	Hematology and Biochemistry	7-3
7.4.1	Specimen Collection	7-3
7.4.1.1	Hematology	7-3
7.4.1.2	Biochemistry	7-4
7.4.1.3	Urine Chemistry	7-4
7.4.2	Hemoglobin Electrophoresis	7-4
7.4.3	Test Schedule	7-4
7.4.4	Shipping Procedures	7-5
7.5	Cytogenetics	7-6
7.5.1	Specimen Collection and Shipment	7-6
7.5.2	Processing Specimens	7-7
7.6	Mutations	7-8
7.6.1	Process for the First 140 Patients	7-8
7.6.2	Process for Patients 141-200	7-9
7.7	Pitted Cells	7-9
7.7.1	Preparation of Whole Blood Sample for Pitted Red Blood Cell Count	7-9
7.7.2	Shipping Procedure	7-10
7.8	Immunology	7-11
7.8.1	Introduction and Rationale	7-11
7.8.2	Recording Immunizations on Form 42	7-12
7.8.3	Schedule of Blood Tests	7-13

7.8.4	Specimen Collection, Preparation and Shipment	7-13
7.8.4.1	Pneumococcal Antibody/Serum Opsonophagocytic Assays	7-13
7.8.4.2	MMR Antibody Studies	7-14
7.8.4.3	T-cell Enumerations	7-15
7.9	Pharmacokinetic (PK) Analysis	7-16
7.9.1	Specimen Collection	7-16
7.9.1.1	Entry and Exit Studies	7-16
7.9.1.2	One-Month Post-Treatment Initiation	7-17
7.9.2	Specimen Packing	7-17
7.9.3	Shipping Procedure	7-17
7.10	Biomarkers	7-18
7.10.1	Specimen Collection and Preparation	7-18
7.10.2	Shipping Procedure	7-19
Exhibit 7-1		7-20
Exhibit 7-2		7-22
Exhibit 7-3		7-23

## 8 PROCEDURES for SPECIAL STUDIES

8.1	Liver-Spleen Scan	8-1
8.1.1	Procedure	8-1
8.1.2	Calculations for Quantitative Assessment	8-2
8.1.3	Labeling and Shipping of Film Sheets	8-3
8.2	Abdominal Sonogram	8-4
8.2.1	Procedure	8-4
8.2.2	Labeling and Shipping of Film Sheets	8-6
8.3	Renal GFR / DTPA Clearance	8-7
8.4	Neurological Assessment	8-10
8.4.1	General Instructions	8-10
8.4.2	History from Caretaker	8-10
8.4.3	Reflexes	8-11
8.4.4	Crawling and Walking	8-14
8.4.4.1	Child Does Not Walk Independently	8-14
8.4.4.2	Gait for Children Who Walk Independently	8-15

8.4.5	Clinical Neurological Diagnosis	8-16
8.4.5.1	Tone	8-16
8.4.5.2	Diagnosis by Study Examiner	8-17
8.5	Bayley Scales of Infant Development	8-17
8.6	Vineland Adaptive Behavior Scales	8-19
8.7	Anthropometric Measurements	8-21
8.7.1	Background	8-21
8.7.2	General Procedures	8-21
8.7.2.1	Weight	8-22
8.7.2.2	Length	8-23
8.7.2.3	Head Circumference	8-24
8.7.2.4	Training and Certification	8-25
8.8	Urine Concentrating Ability	8-26
8.9	Urinalysis	8-28
8.10	O <sub>2</sub> Saturation	8-28
8.11	Transcranial Doppler Ultrasound	8-29
8.11.1	Background	8-29
8.11.2	Consent for TCD	8-29
8.11.3	Arranging a TCD Visit	8-29
8.11.4	Eligibility Based on TCD	8-30
8.11.5	BABY HUG TCD Study Form	8-30
8.11.6	Transcranial Doppler Scanning Protocol	8-31
8.11.6.1	Prior to Recording	8-31
8.11.6.2	Recording the Arterial Vessel Segments	8-31
8.11.6.3	Transferring the TCD Study From the Nicolet Companion	8-33
8.11.7	Processing TCD Exam and Result Notification	8-34
8.11.8	TCD Certification for BABY HUG Clinical Center Examiners	8-34
Exhibit 8-1		8-36
Exhibit 8-2		8-37
9	READING GROUPS	
9.1	Introduction	9-1



9.2	Liver-Spleen Scan	9-1
9.2.1	Overview	9-1
9.2.2	Scans Required for Central Reading	9-1
9.2.3	MCC Scan Processing Procedure	9-2
9.2.4	Guidelines for Qualitative Grading of Liver-Spleen Scans	9-3
9.2.5	Liver-Spleen Primary Outcome	9-3
9.2.6	Guidelines for Quantitative Grading of Liver-Spleen Scans	9-3
9.3	Abdominal Ultrasound	9-4
9.3.1	Overview	9-4
9.3.2	Assessment of the Spleen	9-4
9.3.2.1	Splenic Parenchyma	9-4
9.3.2.2	Splenic Volume	9-4
9.3.3	Assessment of the Kidneys	9-4
9.3.3.1	Renal Parenchyma	9-4
9.3.3.2	Renal Volume	9-5
9.3.4	Gall Bladder and Biliary System	9-5
9.3.5	Liver	9-6
9.3.6	Processing Scans for Central Reading	9-6
9.3.7	Handling the Ultrasound Images	9-6
9.4	Clinical Events	9-7
9.5	References	9-7
10	DATA COLLECTION, ENTRY, EDITING, STORAGE AND ARCHIVAL	
10.1	Clinical Center Data	10-1
10.1.1	Data Collection	10-1
10.1.2	Data Entry	10-2
10.1.2.1	Internet Data Entry System User Access	10-3
10.1.2.2	J-initiator	10-3
10.1.2.3	Form Selection	10-3
10.1.2.4	Study Form Function	10-4
10.1.2.5	Entering Study Form Data	10-4
10.1.2.6	Entering Transmittal Form Data	10-6
10.1.2.7	Save Your Work	10-6
10.1.2.8	Forms That Fail Edit	10-7
10.1.2.9	Internet Failure	10-7

10.1.3	Data Editing	10-7
10.1.3.1	Corrections Function	10-7
10.1.3.2	Editing Data on Archived Documents	10-8
10.1.4	Storage and Archival	10-8
10.2	Central Reader Data	10-9
10.2.1	Liver/Spleen Scans	10-9
10.2.2	Abdominal Sonogram	10-9
10.2.3	Clinical Events Classification	10-10
10.3	Core Laboratory Data	10-10
11	<b>TRAINING AND CERTIFICATION</b>	
11.1	Introduction	11-1
11.2	Training	11-1
11.3	Clinical Center Certification	11-2
11.4	Certification of Clinical Center Personnel	11-3
11.4.1	Principal Investigator	11-4
11.4.2	Clinic Coordinator	11-5
11.4.3	ATRS User	11-5
11.4.4	Neuropsychologist	11-6
11.4.5	Neurologist	11-7
11.4.6	Pharmacist	11-7
11.4.7	Primary Endpoint Person	11-7
11.5	Role of the Medical Coordinating Center in Certification	11-8
11.5.1	Processing Requests for Certification of Clinical Center Staff	11-8
11.5.2	Certification of Clinical Center Staff	11-9
11.5.3	Notification of Certification	11-9
11.5.4	Processing Requests for Certification of Clinical Centers	11-9
11.5.5	Liaison Activities	11-9
11.6	Renewing Clinic Coordinator Certification	11-9
Exhibit 11-1	Financial Disclosure	11-11
Exhibit 11-2	Form 121	11-12
Exhibit 11-3	Form 122	11-14
Exhibit 11-4	Data Entry of Forms by BABY HUG Personnel	11-15
Exhibit 11-5	Form 120	11-16
Exhibit 11-6	BABY HUG Certification Test	11-17

	Exhibit 11-7	Form 123	11-19
	Exhibit 11-8	Standard Patient Narratives	11-20
	Exhibit 11-9	Form 124	11-24
	Exhibit 11-10	Form 125	11-25
	Exhibit 11-11	Form 126	11-26
	Exhibit 11-12	Form 127	11-27
	Exhibit 11-13	Requirements for BABY HUG Individual Certification	11-28
12	STUDY MONITORING AND REPORTING RESULTS		
	12.1	Introduction	12-1
	12.2	Monitoring Patient Safety	12-1
		12.2.1 Real Time Complete Blood Counts	12-2
		12.2.2 Alert Monitoring Levels	12-3
		12.2.3 BABY HUG Adverse Event Reporting	12-3
		12.2.3.1 Introduction	12-3
		12.2.3.2 DBDR Adverse Event Coverage	12-5
		12.2.3.3 Elevated Adverse Event Rate Detection	12-5
		12.2.3.4 Interim Reports	12-6
		12.2.3.5 Analysis of Death or Stroke	12-8
		12.2.3.6 Analysis of Growth and Development	12-9
		12.2.3.7 Analysis of Acute Chest Syndrom, Splenic Sequestration and Serious, Unexpected Adverse Events	12-10
	12.3	Monitoring Data Quality	12-11
	12.4	Monitoring Specimen and Film Quality	12-11
	12.5	Institutional Data and Safety Monitoring and Reporting	12-11
13	MEDICAL COORDINATING CENTER PROCEDURES		
	13.1	Introduction	13-1
	13.2	Objectives of the Medical Coordinating Center	13-1
	13.3	Planning, Training and Meeting Support	13-2
	13.4	Study Documents and Supplies	13-2
	13.5	Clinical Center Communications	13-3
	13.6	Clinical Center Monitoring	13-4
		13.6.1 Protocol Violations and Deviations	13-4

	13.6.2	Weekly Recruitment Reports	13-4
	13.6.3	Performance Reports	13-5
13.7		Treatment Randomization and Allocations	13-5
13.8		Data Collection and Storage	13-5
	13.8.1	Data from Clinical Centers	13-5
	13.8.2	Data from the Core Laboratories	13-5
	13.8.3	Data from Central Readers	13-6
	13.8.4	Data from Clinical Events Reviewers	13-6
	13.8.5	Storage System for Study Documents	13-6
13.9		Data Management and Maintenance	13-6
	13.9.1	Form Data	13-7
	13.9.2	Core Laboratory Results	13-7
13.10		Data Analyses and Reports	13-7
13.11		Data Publication and Reporting	13-7
13.12		Patient Privacy, Confidentiality of Data, and Data Security	13-8
13.13		Quality Control	13-9
	13.13.1	Certification	13-9
	13.13.2	Quality Assurance of Clinical Center Data	13-9
	13.13.3	Quality Assurance of Information Stored in Computer Database	13-9
	13.13.4	Performance Reports	13-9
	13.13.5	Site (or Audit) Visits	13-10
	13.13.6	Quality Control of the Medical Coordinating Center	13-11
13.14		Medical Coordinating Center Contacts	13-12
14		CLOSE-OUT PROCEDURES	
	14.1	Study Treatment Discontinuation, Monitoring and Unblinding	14-1
	14.2	Family Debriefing	14-1
	14.3	Data Clean Up, Closure and Storage	14-2
	14.4	Final Study Data and Dissemination of Results	14-2
15		ORGANIZATIONAL STRUCTURE AND PARTICIPATING UNITS	
	15.1	Introduction	15-1
	15.2	Participating Units	15-1
	15.2.1	Operations Committee	15-1

15.2.2	Clinical Centers	15-2
15.2.3	Study Coordinator Committee	15-2
15.2.4	Core Laboratories	15-3
15.2.5	Pharmacy Distribution Center and Investigational Pharmacies	15-3
15.2.6	National Heart, Lung, and Blood Institute	15-3
15.2.7	Medical Coordinating Center	15-4
15.2.8	National Institute of Child Health and Human Development	15-5
15.3	Study Administration	15-5
15.3.1	Study Chairman and Vice-Chairman	15-5
15.3.2	Steering Committee	15-5
15.3.3	Data and Safety Monitoring Board	15-5
15.3.4	Endpoints Evaluation	15-7
Exhibit 15-1	Organizational Chart	15-8
Exhibit 15-2	Participating Clinical Centers	15-9
16	POLICY MATTERS	
16.1	Introduction	16-1
16.2	Protocol Violations	16-1
16.3	Changes in Principal Investigators	16-2
16.4	Types of BABY HUG Research	16-3
16.4.1	Endpoint Studies	16-3
16.4.2	Data Bank Studies	16-4
16.4.3	Ancillary Studies	16-4
16.5	Clinical Center Access to BABY HUG Data Files at the End of the Study	16-4
16.6	Publication	16-5
16.6.1	Papers Regarding Overall Study Issues	16-5
16.6.2	Other Publications	16-6
16.6.2.1	Papers	16-6
16.6.2.2	Abstracts	16-10
16.7	Conflict-of-Interest	16-11
Exhibit 16-1		16-13

17	USE OF BABY HUG WEB SITE	
17.1	Overview	17-1
17.2	Contents of the BABY HUG Web Site	17-1
17.3	System Requirements to Access the BABY HUG Web Site	17-3
17.4	Site and User Applications	17-4
17.5	Printing Study Forms or Other Documents on the BABY HUG Web Site	17-4
Exhibit 17-1	BABY HUG Web Site Home Page	17-5
Exhibit 17-2	BABY HUG Site Application	17-6
Exhibit 17-3	BABY HUG User Application	17-7
APPENDIX A	PATIENT TIMELINE	A-1
APPENDIX B	STUDY FORMS AND DATA COLLECTION INSTRUMENTS	B-1
APPENDIX C	RADIATION GUIDELINES	C-1
APPENDIX D	GUIDELINES FOR STANDARD CLINICAL CARE INCLUDING ACUTE EVENTS	D-1

# **PEDIATRIC HYDROXYUREA PHASE III CLINICAL TRIAL (BABY HUG) MANUAL OF OPERATIONS**

## **CHAPTER 1**

### **BACKGROUND AND STUDY RATIONALE**

#### **1.1 OVERVIEW OF SICKLE CELL ANEMIA**

The term Sickle Cell Disease (SCD) refers to a group of genetic hematological disorders characterized by the predominance of sickle hemoglobin (HbS). SCD is one of the most common inherited diseases in the United States, affecting approximately 1 in 375 African-American live births. Currently it is estimated that there are over 75,000 persons in the United States with SCD. A single inherited amino acid substitution in beta globin results in the formation of HbS (containing beta-globin S instead of beta-globin A). HbS undergoes polymerization in the deoxygenated state, leading to deformation of the cellular membrane and alteration of cellular physiology. Sickle Cell Anemia (SCA) is characterized by homozygous state for HbS and represents the majority of SCD patients.

Clinical manifestations of SCA result primarily from hemolytic anemia and the effects of intravascular sickling, including both acute tissue hypoxia and chronic organ damage. Patients with SCD commonly develop acute vaso-occlusive events due to sickling of erythrocytes within the capillaries and small venules. Acute vaso-occlusive sickling events can manifest in many ways, including painful crisis, priapism, splenic sequestration, acute chest syndrome, or stroke. Over a period of years, patients with SCA develop organ damage from repeated acute and chronic sickling events. The primary organs that are affected chronically by sickling include the spleen, kidneys, brain, and lungs. Data gathered during the Cooperative Study of Sickle Cell Disease (CSSCD) demonstrate clearly that chronic organ damage is a major cause of morbidity and mortality for patients with SCA.

## **1.2 CHRONIC ORGAN DAMAGE IN SICKLE CELL ANEMIA**

### **1.2.1 Spleen**

Of all internal organs affected by chronic sickling, the spleen is the one damaged most severely early in life. The slow circulation within the spleen provides an ideal milieu for sickling, which leads to tissue hypoxia and organ infarction. In most children with sickle cell anemia, the spleen is non-functional by the age of 2 years (Pearson et al, 1979). This acquired state of functional asplenia (Diamond, 1969) leads to a susceptibility to infection by encapsulated bacteria (Zarkowsky et al, 1986; Gill et al, 1995; Kabins and Lerner, 1970; Pearson, 1977). Splenic damage can be identified by the absence of radioactive tracer uptake, or the presence of increased numbers of pitted erythrocytes (Pearson et al, 1979; Rogers et al, 1982; Pearson et al, 1985; Fatunde and Scott, 1986). Transfusion therapy has been associated with a “reversal” of splenic hypofunction (Buchanan et al, 1989; Barrios et al, 1993), suggesting that splenic damage may be reversible during the first few years of life. Similarly, bone marrow transplantation in children with SCD may be able to correct splenic dysfunction (Ferster et al, 1993). Splenic regeneration may also occur with hydroxyurea (HU) therapy in patients with SCA (Claster and Vichinsky, 1996).

### **1.2.2 Kidneys**

The term “sickle nephropathy” refers to the constellation of chronic renal damage that occurs in patients with SCA. For decades, it has been known that defects in renal tubular function, specifically in acidification (Oster et al, 1976) and concentrating ability (Francis and Worthen, 1968) begin early in childhood, along with papillary necrosis (Eknoyan et al, 1982). More recently, sickle nephropathy has been characterized by proteinuria, occasionally with urinary protein loss in the range of the nephrotic syndrome (Tejani et al, 1985). The prognosis of nephrotic syndrome is poor, with chronic azotemia and acute renal failure occurring frequently (Bakir et al, 1987). The estimated prevalence of proteinuria in SCA is about 6% for children (Wigfall et al, 2000) and 25% for adults (Falk et al, 1992). Focal and segmental glomerulosclerosis and mesangial proliferation



have been described histologically, and probably result from glomerular hyperfiltration (Tejani et al, 1985).

An elevated glomerular filtration rate (GFR) is a common feature in patients with sickle nephropathy that begins very early in life (Allon et al, 1988), and may portend later severe renal damage. Therapy to reduce glomerular capillary hypertension significantly can reduce urinary protein excretion in adults with SCA (Falk et al, 1992). Renal damage from chronic sickling is a significant cause of morbidity and mortality; in the CSSCD, 18% of deaths in adults with SCA occurred secondary to overt organ failure, primarily renal (Platt et al, 1994).

### **1.2.3 Brain**

The CSSCD has collected prospective data on chronic organ damage to the brain in over 300 children with SCD. Using brain magnetic resonance imaging (MRI), 22% of children age 6-12 years had infarction/ischemia and/or atrophy, including 13% who had no history of a clinical CVA (Leong et al, 1997). The lesions in these latter children are referred to as “silent infarcts” that reflect subclinical organ damage to the brain. Most of the lesions were present at entry into the study (age 6 years). More recently, 39 infants with SCA, 7 - 48 months of age, were found to have an 11% prevalence of brain abnormalities on MRI (Wang et al, 1998).

Organ damage to the brain in SCD is often associated with changes in the large intracranial arteries, most commonly stenosis within the distal internal carotid artery (ICA) and proximal middle cerebral artery (MCA). Abnormal cerebral blood flow can be identified in some children by magnetic resonance angiography (MRA), while transcranial doppler (TCD) has been shown to identify children with an increased risk of developing stroke. An abnormal time averaged maximum TCD velocity (>200 cm/sec) in the distal ICA or proximal MCA is associated with a high risk of stroke (Adams et al, 1992). In the Stroke Prevention (STOP) Trial, children with SCA and an abnormal TCD who received monthly blood transfusions had significantly fewer strokes than children who were simply observed (Adams et al, 1998).

Taken together, these data suggest that chronic organ damage to the brain from sickling begins early in life. Moreover, therapeutic intervention may help prevent the development of organ damage to the brain. Even in the absence of overt neurological disease, SCA puts some children at risk for neuropsychological sequelae including lowered intellectual functioning, academic skills deficits, impaired fine-motor functioning, and attentional deficits (Bonner et al, 1999).

#### **1.2.4 Lungs**

The lungs are also frequent target organs in patients with SCA. Episodes of acute chest syndrome (ACS, with intrapulmonary sickling) can result in obstructive lung disease with reactive airways (Leong et al, 1997). However, repeated organ damage from ACS and chronic sickling in the lungs most frequently leads to a restrictive pattern of lung disease with diminished lung compliance (Bowen et al, 1991). Recent studies using pulmonary function tests (PFTs) have suggested that abnormal lung function in SCA may begin in early infancy (Koumbourlis et al, 1997).

### **1.3 SICKLE CELL ANEMIA AND FETAL HEMOGLOBIN**

#### **1.3.1 Fetal Hemoglobin**

There is great clinical heterogeneity observed in SCD, even for patients with an identical hemoglobin phenotype (Platt et al, 1991; Powars, 1991; Seward et al, 1993; Steinberg et al, 1995). This clinical variation is partly explained by differences in the hemoglobin concentration, mean cellular hemoglobin concentration, proportion of dense cells, erythrocyte rheology, % adhesive cells, presence of alpha-thalassemia, and the beta-globin haplotype (Platt et al, 1994; Platt et al, 1991; Steinberg et al, 1984; Baum et al, 1987; Powars, 1991; Phillips et al, 1991; Embury and Steinberg, 1994). The amount of fetal hemoglobin (% HbF) is perhaps the most important parameter influencing clinical severity in SCA (Charache, 1990). Normal adults have <1% HbF (Wood, 1993), while patients with SCA have 1-20% HbF (Serjeant, 1975). Patients with hereditary persistence of fetal hemoglobin (HPFH) can have fetal hemoglobin (HbF) levels that reach 30-40% (Wood et al, 1975). Higher % HbF is associated with decreased clinical severity and fewer painful

events, transfusions, and hospitalizations in sickle cell anemia (Platt et al, 1991; Rucknagel et al, 1987; Odenheimer et al, 1987). A threshold of 10-20% HbF has been postulated, above which patients experience fewer clinical events (Powars et al, 1984). The % HbF also predicts early mortality in patients with SCD (Platt et al, 1994; Leikin et al, 1989).

Except in the case of HPFH, HbF is not found in all erythrocytes, but rather is located in a subset known as HbF-containing cells or “F cells” (Dover et al, 1978; Boyer et al, 1975). In normal adults, the percentage of F cells ranges from 0.5% to 7%, while in patients with SCA, the % F cells has a much broader range (Wood et al, 1975; Dover et al, 1978). Because F cells have a decreased tendency toward sickle formation, they survive preferentially in the peripheral blood of patients with SCA (Dover et al, 1978). The number of F cells, therefore, may be of equal or greater importance than the absolute amount of HbF in influencing the clinical severity of an affected individual with SCA. F cells can be quantitated accurately by several methods, including immunological staining of HbF by monoclonal antibodies, followed by enumeration by visual methods (Horiuchi et al, 1995) or flow cytometry (Dover and Boyer, 1987; Campbell et al, 1999; Marcus et al, 1997).

### **1.3.2 Physiologic Decline of HbF**

Fetal hemoglobin (HbF), the predominant hemoglobin produced in utero, comprises approximately 80-90% of the total hemoglobin at birth. In normal persons, the % HbF declines to adult levels during the first year of life (Wood, 1993). For patients with SCA, this physiologic decline occurs more slowly, and the HbF nadir may not be reached until age 5 years (Mason et al, 1982; Brown et al, 1994). Clinical events from SCA rarely occur in the first 6 months of life, due primarily to high HbF levels. Events occur during the first two years of life, however, including splenic hypofunction (Pearson et al, 1979; Rogers et al, 1982), pneumococcal sepsis (Zarkowsky et al, 1986), splenic sequestration (Topley et al, 1981), dactylitis (Gill et al, 1995), and acute chest

syndrome (Gill et al, 1995). These observations suggest that maintaining high HbF levels might prevent acute and chronic sickling damage.

The physiologic decline in % HbF and % F cells in a cohort of infants homozygous for HbSS between birth and 24 months of age was recently investigated (Marcus and Ware, 1999). The % HbF was measured by 2-minute alkali denaturation and % F cells by flow cytometry (Marcus et al, 1997). The amount of HbF per F cell was calculated using the formula: (mean corpuscular hemoglobin) x (% HbF) ] / (% F cells). Over this period of time, the HbF parameters declined in an exponential fashion (Figure 1-1). At 24 months of age, the average % HbF was  $14.6 \pm 7.3\%$  and the % F cells was  $64.7 \pm 16.9\%$ . The average amount of HbF per F cell fell below 15 pg/cell by age 12 months, confirming data from a previous study (Maier-Redelsperger et al, 1994). Previous in vitro studies have suggested a threshold value of 15 pg HbF per F cell, below which sickling occurs (Sunshine et al, 1979; Poillon et al, 1993). These data demonstrate clearly that HbF parameters decline significantly during the first 1-2 years of life, below levels sufficient to inhibit sickling. These results support the concept of early pharmacologic intervention for very young children with SCA, with the intention to increase HbF parameters to levels that inhibit in vivo sickling.

## **1.4 EFFICACY OF HYDROXYUREA IN SICKLE CELL ANEMIA**

### **1.4.1 Induction of HbF**

The pharmacologic enhancement of HbF can be achieved using a variety of agents including cytotoxic drugs (e.g. 5-azacytidine, hydroxyurea), hematopoietic growth factors (e.g. erythropoietin), and short chain fatty acids (e.g. butyrate and derivatives). Each of these therapeutic agents has been shown to have efficacy for increasing the % HbF in patients with sickle cell anemia (Goldberg et al, 1990; Charache et al, 1992; Perrine et al, 1993; Dover et al, 1994; Charache et al, 1995). However, side-effects and toxicities vary considerably and no direct comparisons of efficacy have been reported. Hydroxyurea is a prototypic therapeutic agent due to its efficacy, ease of administration, and modest toxicity profile.

### **1.4.2 Hydroxyurea For Adults With SCA**

Hydroxyurea has been tested in adults with sickle cell anemia, and in most patients will increase both the absolute amount of HbF as well as the number of F cells (Goldberg et al, 1990; Charache et al, 1992). Charache and co-workers (Charache et al, 1992) reported a mean increase in HbF of 11% in a Phase I/II study of adults receiving daily HU treatment. In the Multicenter Study of Hydroxyurea in Sickle Cell Anemia (MSH) Phase III clinical trial (Charache et al, 1995), adult patients were randomized prospectively either to daily HU or placebo. The study results demonstrated that HU therapy led to a significant reduction in the annual number of painful events, episodes of acute chest syndrome, and erythrocyte transfusions (Charache et al, 1995). The mean increase in % HbF was 8.6%, although the range of HbF responses was substantial and some patients did not respond, possibly due to either non-compliance or exhaustion of marrow reserves (Steinberg et al, 1995). Even when compliance was assured, approximately 20% of adults with SCA did not respond to HU therapy (Rodgers et al, 1990). The primary toxicity of HU therapy was dose-dependent and reversible bone marrow suppression (Charache et al, 1992; Charache et al, 1995).

### **1.4.3 Hydroxyurea For Children With SCA**

After the Phase I/II adult HU trial was completed, several anecdotal reports suggested that HU therapy might be beneficial for children with SCA (Jayabose et al, 1996; Scott et al, 1996; Ferster et al, 1996; de Montalembert et al, 1997). To determine the safety and efficacy of HU therapy for children, investigators from seven institutions administered HU therapy to a total of 84 school-aged children with SCA in an NHLBI-sponsored Phase I/II clinical protocol (HUG-KIDS). HUG-KIDS provided convincing evidence that HU therapy is associated with improved hematological parameters in this younger patient population, including increased % HbF and % F cells (Kinney et al, 1999). The toxicity profile of HU was mild and included primarily reversible myelosuppression. Clinical efficacy was not a stated goal of this Phase I/II study, but it was clear

that the pediatric patients with SCA had a less severe acute clinical course while on HU therapy. Based on these encouraging results in older children, it is reasonable to consider HU therapy for very young children with sickle cell anemia, to allow therapeutic intervention before in vivo sickling leads to acute clinical events and chronic organ damage.

#### **1.4.4 Hydroxyurea For Very Young Children With SCA**

A recent report provided short-term data regarding HU therapy for young children with SCA. Eight children, age 2-5 years, received HU with evidence of both hematological and clinical efficacy, and with minimal toxicity (Hoppe et al, 2000). To determine the feasibility of HU therapy for very young children with SCD, a Phase I/II pilot trial (HUSOFT) was recently performed. Children between age 6-24 months were eligible for enrollment from four institutions, including Duke University Medical Center, St. Jude Children's Research Hospital, University of Texas Southwestern Medical Center, and Medical College of Wisconsin. A total of 21 completed two years of therapy at 20 mg/kg/day. All patients then on study desired to continue treatment for an additional two years at 25 and 30 mg/kg/day. Laboratory studies and physical examinations were performed every four weeks. Patients were closely monitored for toxicities, especially of the blood counts and growth parameters, and for compliance. Routine testing of the complete blood count, %HbF and %F cells were used to document hematological efficacy in before-after comparisons and compared to untreated children with sickle cell anemia. Additional studies included brain MRI/MRA, neurodevelopmental testing, and liver-spleen scans. Hematological toxicities in HUSOFT were well-tolerated, and laboratory efficacy was demonstrated (Wang et al, 2001). Recently, follow-up of the majority of patients from the HUSOFT study who were continued on hydroxyurea treatment for an additional 2-4 years, showed that these patients tolerate prolonged hydroxyurea therapy with sustained hematologic benefits, fewer acute chest syndrome events, improved growth, and possibly preserved organ junction (Hankins et al, 2005).

Preliminary results of clinical efficacy in HUSOFT relate to the potential prevention of chronic organ damage, specifically the possibility that hydroxyurea can help preserve splenic and renal function in some infants with SCA (Wang et al, 2001). Splenic function, as evidenced by uptake of radioactive tracer, was present in eight of 17 HUSOFT children (47%) after two years on study. This compares favorably with data from CSSCD (Pearson et al, 1985) that document elevated pitted cell counts (consistent with functional asplenia) in >80% of children with SCA at the same median age of 39 months. Renal function was assessed primarily by GFR estimation, calculated using the formula [(height) x k] divided by (creatinine), as described by Schwartz (Schwartz et al, 1987). The estimated GFR is normal ( $100 \pm 20$  ml/min) in infants with SCA during the first 6-12 months of life, but quickly rises to 150 ml/min by age 2-4 years and >200 ml/min by age 6-10 years (Wigfall et al, 2000; Kinney et al, 1999; Russell Ware, unpublished observations). Analysis of HUSOFT data reveal that the estimated GFR was  $121 \pm 20$  ml/min/ $1.73 \text{ m}^2$  at study entry (median age 15 months, n=28) and  $162 \pm 43$  ml/min/ $1.73 \text{ m}^2$  at study exit (Franca Barton and Russell Ware, unpublished observations). The absolute change in GFR was strongly associated with change in %HbF (Pearson coefficient -0.60, p=0.004), suggesting that preservation of HbF can help prevent the elevation of GFR observed over time in untreated children with sickle cell anemia.

Recently two groups of investigators have presented evidence that hydroxyurea therapy in children is associated with lower TCD velocities (Zimmerman et al, 2002; Bernaudin et al, 2001).

## **1.5 TOXICITIES OF HYDROXYUREA THERAPY**

### **1.5.1 Organ Damage**

The short-term toxicities of HU for patients with SCA have been carefully studied in two large Phase I/II trials. In the safety trial for adults with SCA (Charache et al, 1992), the only observed short-term toxicity was bone marrow depression. Neutropenia was most common (76%), followed by reticulocytopenia (22%), anemia (4%), and thrombocytopenia (1%). The myelosuppression was typically mild, dose-dependent, and reversible. In the safety trial (HUG-

KIDS) for children with SCA (Kinney et al, 1999), laboratory toxicity occurred at approximately 8% of the clinic visits. Neutropenia was the most common hematological toxicity (63%), followed by reticulocytopenia (19%), anemia (13%), and thrombocytopenia (4%). Hepatic toxicity (>2-fold increase in ALT levels) was observed at only 0.3% of clinic visits, and was not associated with HU dose or additional medications. No episodes of renal toxicity were noted, nor other significant clinical adverse events during this pediatric HU safety trial. Growth (assessed by height and weight) and development (menarche, puberty) also were not adversely affected by HU therapy (Kinney et al, 1999).

### **1.5.2 Neurodevelopmental Effects**

There are limited data in children with SCA regarding the effects of HU therapy on neuropsychological development. Previous small studies of HU therapy for children with SCA did not report any obvious neurodevelopmental decline. Similarly, the Phase I/II HUG-KIDS pediatric safety trial did not specifically test for neurodevelopmental progress, although no obvious declines in neurocognitive function were noted (Kinney et al, 1999). In the HUSOFT infant pilot trial, a subset of patients had full neurodevelopmental testing both at study entry (median score = 93) and at study exit (median score = 89). These values were not statistically different by t-test or Wilcoxon rank sum test (Wang et al, 2001). A recent abstract has suggested that HU therapy is associated with improvement in neurodevelopmental scores (Bernaudin et al, 1999).

Animal data suggest, however, that HU therapy can be toxic for the developing brain. Almost thirty years ago, prenatal treatment with HU was found to cause substantial postnatal effects on rats: perinatal mortality was increased (Fritz and Hess, 1980), weight gain was inhibited (Butcher et al, 1973; Adlard and Dobbing, 1975), locomotor activity was reduced (Fritz and Hess, 1980; Butcher et al, 1973), and maze learning was impaired (Butcher et al, 1973; Adlard and Dobbing, 1975). Given early in gestation, HU therapy also can be embryolethal or have embryotoxic effects on the eyes, face, brain, heart, and limbs (Aliverti et al, 1980). Neuronal cells such as the dorsal



root ganglia may be especially susceptible to impairment of DNA synthesis by HU (Theisen, 1979). A recent abstract suggests that post-natal HU therapy also impairs weight gain, organ size, and brain development of rats (Horiuchi et al, 1998). It must be emphasized that all of these studies used doses of HU up to 1000-2000 mg/kg/day. No studies have documented embryotoxicity or severe neurodevelopmental toxicity using pharmacologic HU doses (20-40 mg/kg/day). Also, effects of HU exposure may be considerably different in rats than in primates (Wilson et al, 1975). Differences in HU plasma levels, half-life clearance, and tissue penetration exist; previous studies suggest that the effects on rodents do not accurately reflect the effects of HU in primates (Wilson et al, 1975). Taken together, the available laboratory and clinical data neither establish nor exclude the possibility that pharmacologic HU doses in early childhood are related to any marked neurodevelopmental toxicity for the human brain, although very high doses of HU could be.

### **1.5.3 Mutagenic And Carcinogenic Potential**

Although the short-term toxicities of HU are typically well-tolerated, the long-term risks associated with HU therapy are unclear. Specifically, the risk of developing leukemia or other malignancies following HU exposure has not been determined. Hydroxyurea has been shown experimentally to have clastogenic (Gebhart, 1981; Oppenheimer and Fishbein, 1965), teratogenic (Murphy and Chaube, 1964; Aliverti et al, 1980) and in some settings mutagenic effects (Ziegler-Skylakakis et al, 1985), but its potential as a carcinogen at therapeutic doses has not been established. Since HU is a potent inhibitor of ribonucleotide reductase and reduces intracellular dNTP pools, HU interferes not only with DNA synthesis but also with DNA repair mechanisms (Snyder, 1984). In vitro, DNA damage that develops either spontaneously or from environmental mutagens cannot be fully repaired in the presence of HU, leading to the accumulation of somatic mutations and chromosomal damage (Li and Kaminskas, 1987). These laboratory observations provide a plausible biochemical mechanism by which in vivo HU therapy could lead to somatic DNA mutations and eventual carcinogenesis.

The carcinogenic potential of HU therapy has been investigated most carefully in patients with myeloproliferative disorders (MPD). The Polycythemia Vera Study Group (PVSG) reported a 5.9% incidence of acute leukemia in 51 adults with PV treated with HU (Fruchtman et al, 1994; Landaw, 1986) compared to 1.5% of historical counterparts who received phlebotomy alone ( $p=0.12$ ). Reports of acute leukemia in adults with MPD treated with HU alone (Sedlacek et al, 1986; Lofvenberg et al, 1990; Holcombe et al, 1991; Weinfeld et al, 1994; Furgeson et al, 1996) have added concern regarding the long-term leukemogenic potential of HU therapy in this clinical setting. Recently, large studies have provided some evidence that long-term HU therapy for patients with MPD is associated with an increased risk of developing acute leukemia (Najean et al, 1997a; Sterkers et al, 1998; Najean et al, 1997b). Taken together, these data suggest that hydroxyurea therapy may have a mutagenic and carcinogenic potential for patients with MPD, especially with long-term usage.

The carcinogenic potential of HU therapy is not evident in the setting of other hematological diseases. Sixty-four patients with erythrocytosis secondary to cyanotic congenital heart disease were treated with HU (mean 5.6 years) and had no cases of secondary malignancy (Triadou et al, 1994). In the United States, some adults with SCA have received HU therapy for over 10 years; no cases of secondary leukemia from the MSH trial have been observed (Steinberg et al, 1999). However, anecdotes of malignancy or myelodysplasia in patients with SCA on hydroxyurea therapy have been reported. These cases need to be evaluated in light of the incidence of cancer in the African-American population in general, and specifically in patients with SCD.

The incidence of cancer among African-American children in the US is about 11 new cases per 100,000 children per year (Gurney et al, 1995), of which one-third are leukemia or lymphoma. The incidence among African-American children under age four years, however, is at least 15 cases per 100,000 children per year (Gurney et al, 1995), due primarily to leukemia, neuroblastoma, and Wilms' tumor (Miller et al, 1993). In the setting of SCA, the incidence of

malignancy is not known. The CSSCD identified 1 child with Wilms' tumor in the original study period and 14 subsequent cases of cancer were reported in children and adults with SCD (Dianne Gallagher and Duane Bonds, unpublished observations). In a large retrospective survey performed by members of the International Association of Sickle Cell Nurses and Physician Assistants (IASCNAPA), a total of 41 cases of cancer were reported in patients with sickle cell anemia. These cases included children and adults of all ages, and a wide variety of cancer types were reported (Schultz et al, 1999).

#### 1.5.4 Acquired DNA Mutations In Association With Hydroxyurea Therapy

The inhibitory effects of HU on DNA repair mechanisms could lead to an accumulation of acquired DNA mutations that eventually could result in malignant transformation. Two in vitro assays of DNA damage can measure the mutagenic effects of in vitro and in vivo hydroxyurea exposure: the hypoxanthine phosphoribosyltransferase (HPRT) assay that measures the frequency of mutations at the selectable *hprt* gene locus (Albertini et al, 1982; O'Neill et al, 1987), and the VDJ gene locus assays that detect "illegitimate" interlocus recombination events between the T-cell receptor V $\gamma$  and J $\beta$  gene loci within chromosome 7 (Stern et al, 1989; Lipkowitz et al, 1992). Using these two quantitative assays, the mutagenic effects of in vitro and in vivo hydroxyurea exposure were measured (Hanft et al, 2000). In vivo HU exposure was not associated with more DNA mutations in adults with SCD or myeloproliferative disorders (MPD), but was associated with a suggestively higher numbers of VDJ events in children with SCD (Table 1). These results suggest that the mutagenic potential of HU exposure is low, and serial studies should be performed in young SCD patients on HU therapy.

Patient Population	# patients	Mean Age (years)	Median HU exposure	HPRT M <sub>f</sub> (x 10 <sup>-6</sup> )	VDJ events (per $\mu$ g DNA)
Adults with MPD	27				
Low HU exposure	15	57 $\pm$ 17	0 months	37.3 $\pm$ 37.6	1.06 $\pm$ 0.73
Prolonged HU exposure	12	62 $\pm$ 16	11 years	41.1 $\pm$ 29.3	0.64 $\pm$ 0.29
Adults with SCD	30				
No HU exposure	15	27 $\pm$ 12	0 months	19.1 $\pm$ 19.1	1.07 $\pm$ 0.38

Patient Population	# patients	Mean Age (years)	Median HU exposure	HPRT M <sub>f</sub> (x 10 <sup>-6</sup> )	VDJ events (per µg DNA)
Short HU exposure	15	29 ± 9	24 months	16.7 ± 10.9	1.14 ± 0.38
Children with SCD	38				
No HU exposure	21	11 ± 3	0 months	11.5 ± 18.7	1.06 ± 0.45
Shorter HU exposure	17	11 ± 3	7 months	11.2 ± 6.7	1.58 ± 0.87
Longer HU exposure	17	13 ± 3	30 months	9.2 ± 7.8	1.82 ± 1.20
Normal Controls	32	43 ± 15	0 months	25.8 ± 24.8	1.04 ± 0.38

**Table 1.** Patient characteristics and quantitation of acquired DNA mutations after in vivo hydroxyurea exposure. Patient and control PBMC were tested for DNA mutations in both the HPRT and VDJ assays. The 27 adults with MPD, with either low or prolonged HU exposure, had no significant differences in *hprt* M<sub>f</sub> or number of VDJ recombination events. Adults with SCD also had no significant differences, according to HU exposure. Children with SCD and HU exposure had more VDJ events compared to those with no HU exposure, P=0.04 by ANOVA (Hanft, 2000).

## 1.6 SUMMARY

Decades of observational data, including landmark studies from the CSSCD, have documented that sickle cell anemia is a severe, debilitating hematological disorder. The morbidity and mortality of SCA arise from both acute vaso-occlusive events and chronic organ damage. Protection from HbF is typically lost in infancy and early childhood, with the physiologic decline of HbF. Accordingly, therapy designed to prevent chronic organ damage in SCA should be considered early in life. Hydroxyurea has emerged as an exciting therapeutic agent for patients with SCA, due to its ease of oral administration, modest toxicity profile, laboratory efficacy with increased %HbF, and clinical efficacy for acute vaso-occlusive events. The efficacy of HU in preventing chronic organ damage has not been tested, but data from the pilot HUSOFT trial suggest that HU may help prevent damage to the spleen and kidneys compared to expectations from the CSSCD and nonrandomized groups (Wang et al, 2001; Hankins et al, 2005) not given HU. Finally, hematological and neurodevelopmental toxicities from HU in infants and young children with SCA appear to be mild or absent. Taken together, the available data make a compelling case for the proposed Phase III trial of hydroxyurea in very young children (9 through 17 months of age) with SCA, designed to prevent chronic organ damage.

Figure1-1

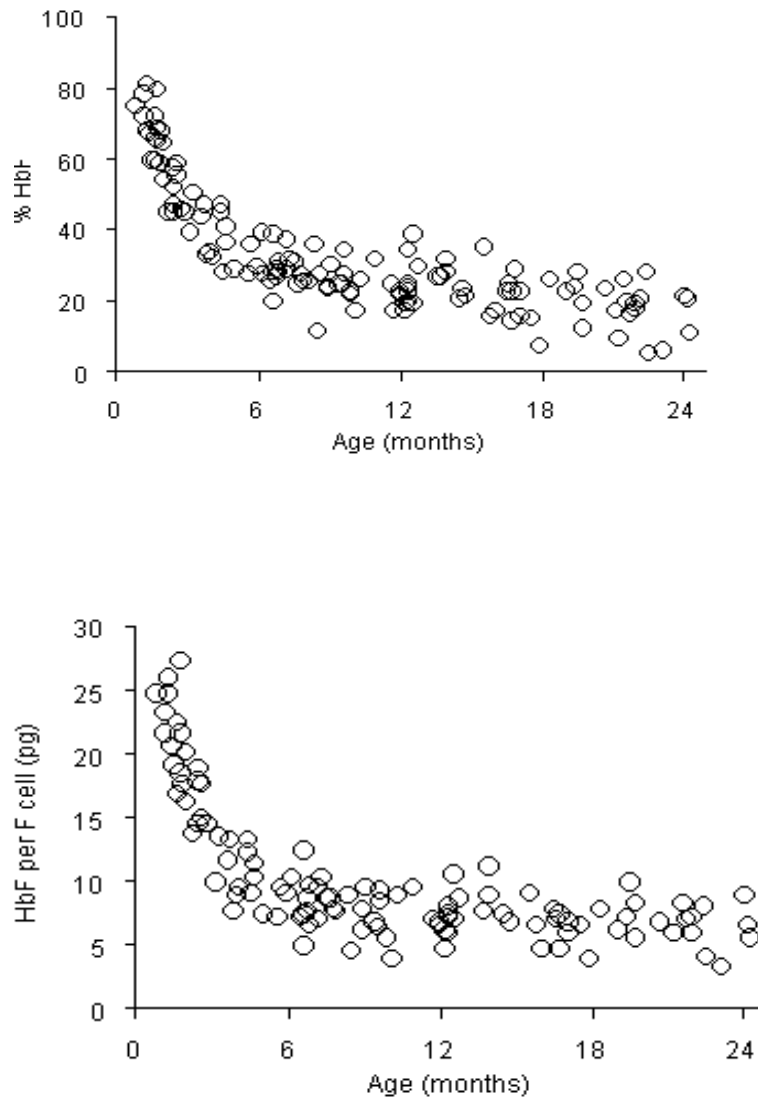

Figure 1.1. Measurement of HbF parameters in infants with HbSS over the first 24 months of life (Marcus and Ware, 1999). The top panel illustrates the exponential decline in % HbF as a function of age. At 12 months, the average HbF (mean  $\pm$  1SD) is  $24.5 \pm 5.0$  %, and at 24 months is  $14.6 \pm 7.3$  %. The lower panel plots the calculated value of HbF per F cell versus age, showing a exponential decrease to below 15 pg/cell at age 12 months and below 10 pg/cell by age 24 months, below the threshold of HbF per cell that inhibits in vitro sickling (Sunshine et al, 1979; Poillon et al, 1993).

# PEDIATRIC HYDROXYUREA PHASE III CLINICAL TRIAL (BABY HUG) MANUAL OF OPERATIONS

## CHAPTER 2

### OBJECTIVES AND DESIGN OF THE TRIAL

#### 2.1 INTRODUCTION

Hydroxyurea (HU) has demonstrated laboratory and clinical efficacy for adults with sickle cell anemia (SCA). In this patient population, several studies have demonstrated that HU increases the hemoglobin concentration, mean corpuscular volume, and fetal hemoglobin (HbF) parameters including %HbF and % F cells. Toxicities are mild and primarily include transient and reversible neutropenia. In the Multicenter Study of Hydroxyurea in Sickle Cell Anemia (MSH) clinical trial, which was an NHLBI-sponsored randomized, double-blinded, placebo-controlled trial in adults with SCA, HU reduced the number of acute vaso-occlusive episodes such as painful events and acute chest syndromes, transfusions, and hospitalizations (Charache et al, 1995).

Pediatric patients with SCA also benefit from HU therapy. Phase I/II trial (HUG-KIDS) involving 84 children who were 5-15 years old concluded that HU was well tolerated by pediatric patients with SCA, and the laboratory effects were similar to those observed in adults (Kinney et al, 1999). Several smaller studies have further suggested that HU has clinical efficacy in this younger age group (Hoppe et al, 2000; Bernaudin et al, 1999), and reduces the number of acute vaso-occlusive events. A pilot trial involving infants and very young children with SCA (HUSOFT) has provided preliminary data demonstrating that HU is well-tolerated in this very young age group, with laboratory effects similar to those for older children (Wang et al, 2001; Hankins et al, 2005).

Although HU therapy has emerged as an exciting and efficacious therapeutic agent for patients with SCA, important issues remain regarding its use, especially for children less than 2 years old. Perhaps the most important issue is whether or not HU therapy can prevent chronic organ damage secondary to vaso-occlusive sickling. HUSOFT data are suggestive, but not conclusive, regarding the potential for hydroxyurea to prevent chronic organ damage, specifically

in the spleen and kidney. Ideally, HU therapy to prevent organ damage would begin early in life, before repeated sickling events begin to damage the spleen, brain, kidneys, and lungs. Another important issue regarding HU therapy relates to its mechanism of action, e.g., whether or not HbF parameters mediate the prevention of chronic organ damage. Finally, there are questions about the long-term safety of HU administration for young patients with SCA, including its effects on growth and development, as well as its mutagenic and carcinogenic potential.

At this time, however, there are limited data regarding the toxicities, effects on growth and development, and occurrence of adverse events in this very young age group (9-17 months). Moreover, the accurate and reproducible quantitative measurements of splenic and renal function have not been fully validated. For these reasons, a Feasibility and Safety Pilot Study has been performed to (1) determine the feasibility of the protocol design, (2) provide additional safety and toxicity data, and (3) validate the proposed methods of evaluating splenic and renal function.

## **2.2 SPECIFIC AIMS**

The primary aim of this trial is:

1. To determine whether daily oral hydroxyurea can reduce by  $\geq 50\%$  chronic organ damage that develops in young children with sickle cell anemia.

Secondary objectives of this trial include:

1. To determine the relationship between fetal hemoglobin (HbF) levels and chronic organ damage in young children with sickle cell anemia;
2. To investigate the safety of HU for young children with sickle cell anemia regarding
  - a. physical growth and development,
  - b. neuropsychological development,
  - c. immunological responses, and
  - d. mutagenic effects on DNA.

## **2.3 DESIGN OF THE TRIAL**

### **2.3.1 Overview of the Trial**

This NHLBI- and NICHD-sponsored Phase III therapeutic trial will be a randomized, placebo-controlled double-blinded study and will involve 14 Clinical Centers, a Medical Coordinating Center, and eight core laboratories within the United States. The Phase III study will include 200 children with sickle cell anemia (SCA) aged 9-17 months. A Feasibility and Safety Pilot Study has enrolled 40 children from 12 to 17 months of age. Each child was randomly assigned to either hydroxyurea or placebo and will receive study treatment for no more than two years (see Figure 2-1). Selected data from all 40 children in the Feasibility and Safety Pilot Study have been presented to the DSMB and a decision has been made regarding reopening recruitment for the full study. After the children's treatment period has ended, they will remain in study follow-up to determine whether or not there are untoward effects of discontinuing study treatment. After study treatment ends, renewed consent will be requested for continued follow-up clinic visits for up to five years after the end of study treatment.

The target dose of hydroxyurea will be 20 mg/kg/day in liquid formulation or equivalent volumes of placebo. A Medical Coordinating Center and Pharmacy Distribution Center will ensure that patients and investigators are blinded to the treatment assignments of individual patients. A battery of laboratory tests and special studies will be performed at entry and exit. Clinical events (including death, acute chest syndrome, and stroke) and other outcomes will be classified by a central evaluation panel, blind to treatment assigned and under the direction of the Medical Coordinating Center. Interim results will be monitored by an NHLBI-appointed Data and Safety Monitoring Board according to statistical plans outlined in the Protocol (Chapter 4) and elaborated in a separate document prior to the start of recruitment. Long-term follow-up in an observational study after study treatment is terminated in BABY HUG is anticipated so that children enrolled in BABY HUG will be observed for growth and safety outcomes for at least four years, if resources for the follow-up can be obtained.

### **2.3.2 The Feasibility and Safety Pilot Study**



The 40 children enrolled in the Feasibility and Safety Pilot Study will be on study treatment for two years. The DSMB authorized immediately continuing recruitment for the remaining 160 children in the full Phase III BABY HUG Clinical Trial. The anticipated recruitment and follow-up periods are presented in Figure 2-1. The Primary Aims of the Feasibility and Safety Pilot Study were:

1. To determine the feasibility of BABY HUG in terms of recruitment, follow-up, adherence to study treatment, and compliance with the study schedule of procedures;
2. To assess hydroxyurea toxicity, effect on growth and development, and occurrence of severe/unexpected adverse events;
3. To establish the distribution and inter-observer and intra-observer variability of spleen function based on dual, independent readings of liver-spleen scans;
4. To evaluate the validity and variability of glomerular filtration rate (GFR) as estimated by serum creatinine and height (the Schwartz formula) compared with a “gold standard” such as DTPA clearance; and,
5. To assess some pharmacokinetic parameters of hydroxyurea in the BABY HUG age group.

At study entry, plasma specimens for pharmacokinetics were collected from the blood collected as part of the radionuclide (DTPA) study (at 1, 2 and 4 hours following radionuclide injection), in addition to plasma specimens collected at time 0 and 8 hours from the start of the test. After counting radioactivity in the plasma for the renal function study, the plasma from each specimen was saved, frozen (-70° C) for at least a month (well after all radiation decays) and shipped on dry ice for pharmacokinetic evaluations. The 8-hour specimen was collected after the DTPA study and was handled similarly to the other four specimens. Measurements of hydroxyurea levels were made on specimens from all 40 children in a commercial laboratory recommended by the manufacturer for regulatory purposes. Children assigned to placebo were also tested for DTPA

according to the same schedule; their plasma was prepared and shipped for HU determination just as the HU-assigned specimens.

The DSMB Chair, Executive Secretary of DSMB, and the NHLBI Project Officer reviewed monthly and semi-annual Feasibility and Safety Pilot Study reports including information on:

1. Recruitment: Expected vs. Actual (overall), and reasons for ineligibility
2. Patients screened, eligible and randomized
3. Patient characteristics at baseline (overall)
  - a. Age, race and gender
  - b. Spleen function (scan reading)
  - c. Spleen and kidney size (by ultrasound evaluation)
  - d. Pitted cell counts
  - e. Schwartz equation GFR estimates
  - f. DTPA clearance for GFR quantitation
  - g. Urine concentrating ability
  - h. CBC and reticulocyte count
  - i. Presence of gallstones
  - j. Blood chemistries
  - k. Microalbuminuria
  - l. O<sub>2</sub>% saturation
  - m. Physical examinations
  - n. Neurological examination and neuropsychological tests
  - o. Height, weight, head circumference
  - p. Transcranial doppler (TCD) measurements (supported by grant funds independent of BABY HUG contracts)
4. Blood count toxicities
5. Dose adjustments

6. Intra- and Inter-observer agreement of liver-spleen scan readings
7. GFR estimated from the Schwartz equation versus measured by DTPA
8. Immunological impairment
9. Safety assessments and adverse events
  - a. Height, weight and head circumference
  - b. Neurological examination and neuropsychological development
  - c. Unexpected and serious adverse events: counts and percentages. Individual cases were summarized also for immediate review by the DSMB Chair, the Executive Secretary of the DSMB, and the NHLBI Project Officer.

Based on individual patient and group safety monitoring reviews, the Executive Secretary of the DSMB, the NHLBI Project Officer and/or DSMB Chair could recommend full DSMB review or individual treatment interruptions. All individuals whose treatment was interrupted continued to be monitored. There were monthly reviews of accumulating data for safety.

If height, weight, head circumference or Bayley scores were worse among children assigned to HU than children assigned to placebo through the early months (at least three) of randomized study treatment, the DSMB could have recommended to the NHLBI that the full Phase III trial not proceed in children less than 18 months of age. If serious adverse events (e.g., death, stroke, or splenic sequestration) were more frequent among children assigned to HU than among children assigned to placebo, to a greater degree than could be expected by chance, the DSMB could have recommended to the NHLBI that the study be discontinued. If spleen function according to liver-spleen scan readings was absent at entry for more than 40% of the children enrolled, the DSMB could have recommended to the NHLBI to re-design the primary outcome or other features of the study design (e.g., eligibility criteria) as necessary. See Protocol Chapter 4 for detailed study stopping rules.

## **2.4 ENDPOINTS**

1. The primary endpoints are chronic organ damage to the spleen and kidney.

- a. Spleen -- organ damage will be defined as decrease or loss of radionuclide  $^{99m}\text{Tc}$  uptake (relative to the liver) at 2 years from baseline; and,
  - b. Kidney -- organ damage will be defined as an elevated glomerular filtration rate measured by  $^{99m}\text{Tc}$  - DTPA clearance, at two years from baseline.
2. Secondary endpoints for this study include the following:
- a. Spleen -- pitted cell count, size as measured by ultrasound;
  - b. Kidney--urine specific gravity, osmolality, urinalysis including microalbuminuria, size as measured by ultrasound;
  - c. Lung -- oxygen saturation (percutaneous monitor);
  - d. Hepatobiliary – cholelithiasis (ultrasound evaluation), serum bilirubin (direct);
  - e. Hematology and Chemistry -- hemoglobin F, serum bilirubin (indirect);
  - f. Clinical events -- e.g., hospitalization, pain, splenic sequestration, splenomegaly, and acute chest syndrome occurrence; and,
  - g. Transcranial doppler – time averaged maximum flow velocity in the distal internal carotid/proximal middle cerebral arteries.
3. Safety endpoints include the following:
- a. Death, stroke, TIA, splenic sequestration, prolonged hospitalization (greater than 7 days), life threatening events, acute chest syndrome, ICU admissions;
  - b. Growth -- weight, height, head circumference;
  - c. Brain -- neurodevelopmental testing, neurological examination;
  - d. Mutagenesis -- VDJ recombination events (first 140 patients), chromosomal karyotype and breakage studies;
  - e. Hematology and Chemistry -- hemoglobin, platelets, liver function, etc.; and
  - f. Immune System -- antibody response to immunizations, T-cell counts and antigen-specific responses.

## 2.5 SAFETY MONITORING

1. Individual patients will be monitored according to routine hematology and biochemistry parameters (see Protocol Section 6.5). Patients will have treatment interruptions if any of the following occur:
  - a. a “toxicity” as defined in Protocol Section 6.5;
  - b. the DSMB confirms a central review recommendation that a decline across two major percentile lines, or drop below the 1.5<sup>th</sup> percentile on age-specific standard growth curves based on confirmed measurements in height, or weight or head circumference growth warrants a treatment interruption (central reviewers for this aspect of the study are two physicians who are not seeing patients and are not associated with any of the Clinical Centers);
  - c. Bayley standardized Mental score that falls to < 70 (confirmed on repeat evaluation within three months); or
  - d. clinical stroke, or failure of head circumference to increase according to normal growth curves.

Treatment will not be terminated unless a toxicity condition persists or therapy that contraindicates study treatment – such as chronic transfusion – is initiated, to allow the determination of primary, secondary and safety endpoints in that patient. Children whose treatment is terminated, whether assigned to hydroxyurea or placebo will complete as much follow-up in BABY HUG as possible (e.g., all primary endpoint assessments and growth and development assessments will be expected).

2. Group comparisons between hydroxyurea-assigned patients and placebo-assigned patients will be included in semi-annual reviews of the data by the Data and Safety Monitoring Board (see Protocol Section 4.4). These reviews will include all secondary and safety endpoints defined in the study. Safety comparisons and

inferences based on them will be discussed by the DSMB as data accrue in the study.

3. Monitoring for unanticipated adverse clinical effects will be done using adverse event (AE) forms that will be submitted to the Medical Coordinating Center (MCC) and tabulated based on the affected organ system. A central review group (consisting of two pediatric hematologists with expertise in sickle cell disease and without association with the Clinical Centers) will designate each event as serious or non-serious. Each suspected serious AE (SAE) will be reported to the MCC within 24 hours of the event. MCC staff will immediately review the material and forward it to the central review group. If the central review group finds that an event is serious, MCC staff will send the information to the NHLBI and NICHD Project Officers. The NHLBI Project Officer will forward the information to the FDA. The Clinical Centers will report the occurrence of serious AEs that occur at their institution according to the requirements of their local IRB. Further plans for adverse event detection and assessment are in Protocol Sections 4.3 and 4.4.

Figure 2-1  
 Projected Enrollment, Maintenance of Assigned Study Treatment  
 (Gray Areas) and Follow-up to Common Termination N

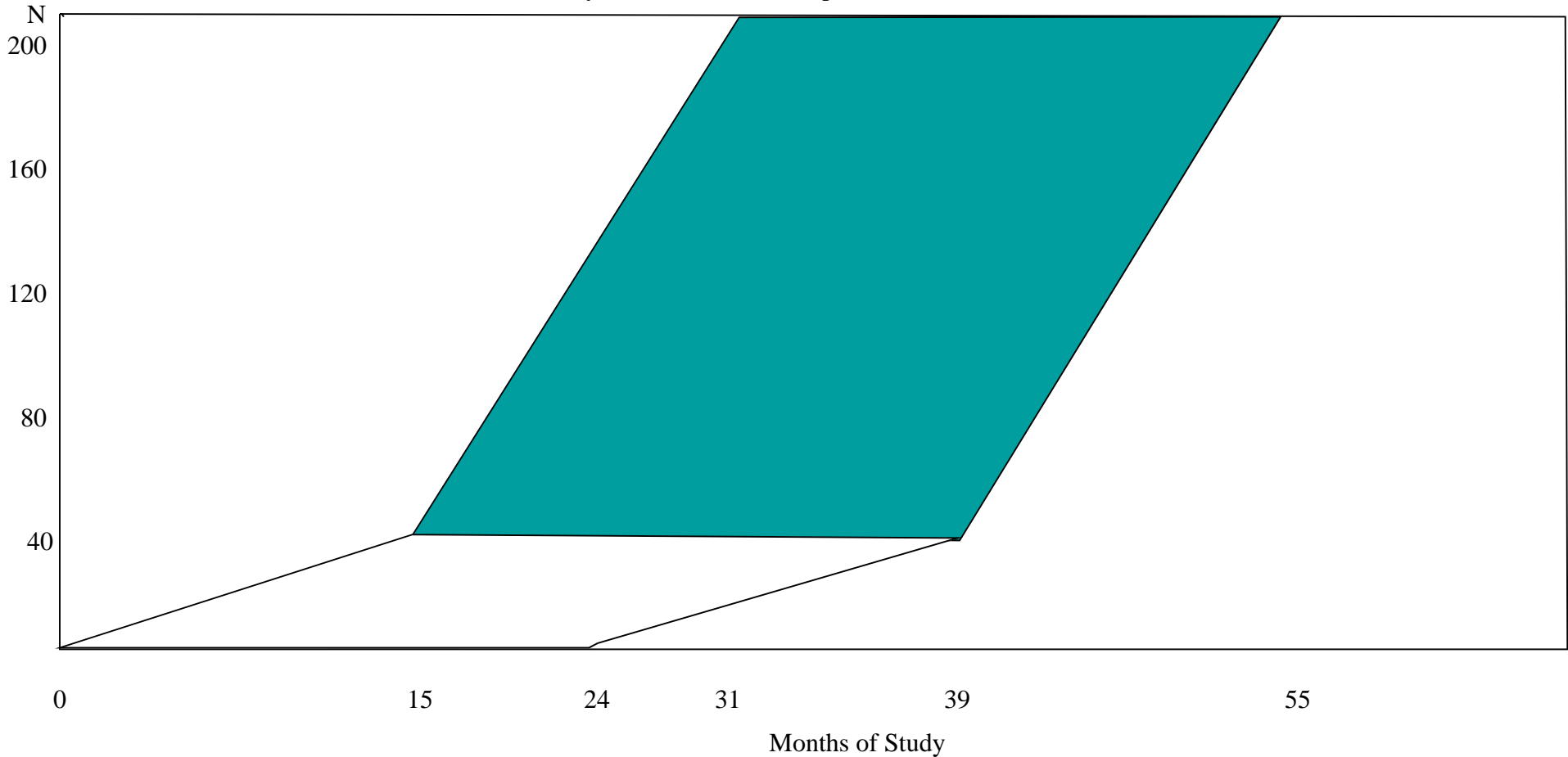

INTERIM MONITORING LOOKS FOR EFFICACY:  
 (# on HU / # on PLBO)

1	2	3	4	(Final)
(20/20)	(40/40)	(60/60)	(80/80)	(100/100)

**BABY HUG Projected Enrollment, Maintenance of Assigned Study Treatment (Gray Areas) and Follow-Up**

Light gray: Feasibility and Safety Pilot Study (N=40 children are enrolled over 15 months and each maintained on assigned study treatment for 24 months)  
 Dark gray: Remainder of Phase III Clinical Trial cohort (N=160 additional children are enrolled over 16 months and each maintained on assigned study treatment for 24 months)

Follow-up may continue for up to 5 years or longer after the end of study treatment.

06/22/06

**PEDIATRIC HYDROXYUREA PHASE III CLINICAL TRIAL (BABY HUG)  
MANUAL OF OPERATIONS**

**CHAPTER 3**

**PATIENT ELIGIBILITY, RECRUITMENT, ORIENTATION,  
AND INFORMED CONSENT**

**3.1 INTRODUCTION**

The primary objective of this study is to determine whether hydroxyurea administration can prevent organ damage commonly found in young children with sickle cell anemia. This will be accomplished by the administration of hydroxyurea or placebo (randomly assigned) to a group of very young children with sickle cell anemia (or sickle beta zero thalassemia) at an age before extensive organ damage has usually occurred.

Parents (or guardians) of the first forty patients enrolled were informed that they were participating in a Feasibility and Safety Pilot Study -- randomized, placebo-controlled, and double-blind -- testing oral hydroxyurea for the prevention of primary end organ damage (spleen and kidney) in children with sickle cell anemia 12 through 17 months of age at entry. The DSMB authorized additional recruitment after the Feasibility and Safety Pilot Study without an interim wait. All families will be informed that their renewed agreement will be sought at the end of treatment for five years or up to ten years of follow-up clinical visits.

The end-organ damage found in sickle cell anemia is not uniform in time of onset or distribution across organs. While all organs and systems may ultimately be affected, the timing and severity of organ damage is variable. For example, damage to the spleen and brain is known to begin early in life, while that affecting the bones and eyes occurs later. An additional 160 patients from 9 months through 17 months of age will be enrolled, before the frequency of extensive organ damage is high. However, even at that young age, some children will already have early evidence of disease-specific organ damage.

Care should be taken to avoid coercion of this vulnerable population of parents of children with sickle cell anemia. Many of these parents are young, some single heads of households, some limited in English language skills, and some may have highly constrained financial resources. Advisory Patient/Family advocates will be established with representation from each Clinical Center to advise families independently of any discussions with study investigators or health care



providers. The services of these advocates will be supported from study resources. Documentation of thorough review of the study and consent form with a Patient/Family Advocate will be required of each family enrolling a child in BABY HUG. The consent form will be appropriately worded and available in translation as needed at individual Clinical Centers. Clinical Center Principal Investigators and staff will be sensitive to the need to diminish the burdens of the study on patients and families without compromising safety; funds will be provided to families for the purpose of removing barriers to participation rather than being inducements for enrolling dependent children to provide experimental observations.

### **3.2 RECRUITMENT**

Each BABY HUG Clinical Center must have an active recruitment phase designed to enroll patients into the study. Clinical Center staff will identify potentially eligible children. The Clinical Center should draw upon its own patient rosters for potential patients, as well as additional local patients who fall within its catchment area. Patients who are not normally followed at a Clinical Center are eligible for enrollment. It is anticipated that most eligible children will be known to the Clinical Centers through referrals after identification through newborn screening programs. A calendar, Enrollment and Eligibility Screening Birth Dates, is available on the BABY HUG website under “Study Tools” to aid in recruiting children in the required age category. Publicity for the sickle cell community and physicians concerning the BABY HUG Study should occur at each Clinical Center according to local needs and should be at the discretion of the Principal Investigator with appropriate Institutional Review Board and National Heart, Lung, and Blood Institute approval.

### **3.3 PARENT/GUARDIAN ORIENTATION**

Before providing information on BABY HUG to potential families, each Clinical Center should provide education to potential families about sickle cell anemia and the current experience with hydroxyurea including evidence of clinical benefit in adults and apparent safety in children above one year of age. Known risks should be described in detail along with the fact that relatively little is known about drug effects in this age group. A list of the known and possible risks (including possible malignancy or growth retardation which are not definitely known to be risks of HU) should be provided to families along with Internet addresses for sites that describe hydroxyurea use in detail. The preliminary orientation should also include information about controlled randomized,

blinded clinical trials. After the preliminary orientation, the Clinical Center should describe the purpose and overview of the study.

The Protocol and related issues should be discussed in detail and a copy of the consent form provided to the parents or guardians to consider at home. Parents (or guardians) should be given a list of baseline evaluations that must be completed prior to study entry and an explanation that children who do not complete the baseline evaluations cannot enroll in BABY HUG. They should be provided with a list of tests and procedures that will be required after they enroll their child in BABY HUG, including the radionuclide kidney function test which is done at treatment initiation. Explanations of these procedures should include the risk of radiation exposure associated with the radionuclide kidney function test and the liver-spleen scan.

Parents (or guardians) should be informed that their child's participation in BABY HUG and their child's treatment, which will be made known to them at the end of the last-enrolled child's treatment in the study (along with study conclusions), should be noted in their child's medical record. This information should be provided by the parents (or guardians) to all doctors taking care of their child. At the start of each child's long-term follow-up, the parents (or guardians) will be contacted for permission to examine their children for up to five to ten years to learn about any long term effects the study treatment may have.

Parents (or guardians) who express interest in BABY HUG should be advised of the importance of adherence with study visits and procedures. Evidence of compliance with clinic visits and of compliance with standard care for sickle cell anemia such as prophylactic penicillin administration will be documented in BABY HUG. Study personnel should use this information to estimate the family's likelihood of complying with study requirements.

### **3.4 PATIENT/FAMILY ADVOCATES**

Each BABY HUG Clinical Center must develop a plan to have a third party person (Patient/Family advocate) involved to advise families independently of any discussions with study investigators or health care providers in order to eliminate any coercion, in particular because of the vulnerable study population. These plans will each be reviewed by the BABY HUG Data and Safety Monitoring Board (DSMB). The Patient/Family advocates cannot be employees of the BABY HUG Clinical Centers, Departments of Pediatrics, or the Divisions of Pediatric Hematology

/Oncology in which a Clinical Center is organized. Some BABY HUG Clinical Center Institutional Review Boards employ a full time staff to function in this capacity.

All potential study patients' families should be referred to a Patient/Family advocate. Meeting(s) with the Patient/Family advocate must be documented for each child enrolling in BABY HUG.

### **3.4.1 Qualifications**

The following are minimal general requirements for a Patient/Family advocate.

- Familiarity with clinical trials/informed consent
- Familiarity with bio-ethics concepts
- Complete NIH acceptable human subjects training
- Independence from BABY HUG investigators

### **3.4.2 Responsibilities and Activities**

The Patient/Family advocate role focuses on ensuring that systems are in place and working effectively to minimize research-related risks experienced by patients and families, address concerns or complaints that arise from treatment or research, and facilitate resolution of substantive issues that could have negative impacts on patient/family understanding of and participation in research. The Patient/Family advocate acts as an impartial advocate to ensure that patients/families are treated fairly and equitably, are directed to appropriate resources within the institution for resolution of non-clinical, operational problems and are assisted in their communication with all Clinical Center staff. The Patient/Family advocate is responsible for appropriately collaborating with all internal and external resources required to bring closure to the issues presented. They are involved from preliminary orientation through closure of the study.

Their responsibilities are:

- Ensure that patients/families are treated fairly and equitably
- Assist families in communication of concerns, complaints, or questions that arise from participation in the study
- Facilitate resolution of substantive issues that influence participation in research
- Direct patients/families to appropriate resources within the institution
- Meet potential BABY HUG subjects/families prior to enrollment, to review the study and address concerns

- Ensure understanding of the risks and benefits of the study
- Ensure that the patient's family understands the randomization process and that the subject may receive a placebo
- Clarify each patient's/family's rights and responsibilities
- Monitor the informed consent process
- Maintain availability and contact with families during the course of the study.

### **3.5 INFORMED CONSENT**

Each Clinical Center must prepare a consent form based on the model informed consent approved by the Data and Safety Monitoring Board (see Protocol Chapter 3). Recruitment brochures or advertisements (including a study newsletter), the Protocol and any amendments, and the consent form must be submitted for approval by the local Institutional Review Board. Each Clinical Center's final consent form will be reviewed by the NHLBI to ensure all appropriate issues are addressed.

The Clinical Center Principal Investigator will obtain the consent from each family. If both parents are reasonably available and responsible for the child, they should both be asked for signed, informed consent. Copies of the signed consent form must be given to the parents (or guardians) and placed on the child's medical record. The original must be maintained in study files by the Principal Investigator.

### **3.6 ELIGIBILITY ASSESSMENT**

BABY HUG employs a two-stage eligibility screening process. The first step involves determining if a child *meets* the inclusion criteria and *does not meet* any of the permanent exclusion criteria. Some exclusion criteria are transient, so it also involves the evaluation and possible re-evaluation of these criteria. The second stage of the eligibility screening process consists of an extensive set of blood tests, urine tests and special studies procedures. All of these tests and studies must be performed (or attempted for some special studies) in order for the child to complete the eligibility process. The results of these screening tests and special studies will also be the child's baseline assessments. The child is not **enrolled** in the study until s/he is declared fully eligible by the MCC, and randomization is requested and issued (see Chapter 4).

### **3.6.1 Eligibility Screening I**

Form 04 (Eligibility Screening I) is used to record the results of the first stage of the eligibility screening process. (Information can be recorded as it becomes available.) Form 04 is to be completed for all patients who have consented to participate in BABY HUG. Completing this form and keying it into the BABY HUG database at the MCC via the BABY HUG website registers the child as having been **screened** for the study. Tabulations will be made and reported to the Data Safety and Monitoring Board (DSMB) of all children screened, whether enrolled into the study or not, and reason(s) not enrolled. The following are the BABY HUG inclusion and exclusion criteria that must be assessed for each child.

#### **3.6.1.1 Inclusion Criteria**

- Children with majority fetal and sickle (FS or SF) hemoglobin pattern confirmed centrally by gel electrophoresis.
- Eligible children will be between 9 and 17 months (up to 18 months) of age. However, patient screening may begin at 7 months of age.
- Parents or guardians must provide informed consent.
- Patients or guardians must provide Health Insurance Portability and Accountability Act (HIPAA) authorization.
- The family must have reliable telephone service 24 hours a day, 7 days a week.

#### **3.6.1.2 Exclusion Criteria**

Chart review and initial visits should be used to determine if a child is ineligible for BABY HUG due to the following exclusion criteria. For the transient exclusion criteria, a child can be re-evaluated for eligibility.

##### Permanent Exclusions

- Chronic transfusion therapy.
- Malignancy.
- Less than 5<sup>th</sup> percentile height, weight or head circumference for age as measured at time of consent or up to two weeks prior.
- Severe developmental delay (e.g., cerebral palsy or other mental retardation; Grade III/IV intracranial hemorrhage).
- Stroke with neurological deficit.

- Surgical splenectomy.
- Participation in other clinical intervention trials.
- Probable or known diagnosis of Hemoglobin S-Hereditary Persistence of Fetal Hemoglobin.
- Known hemoglobin S-beta plus thalassemia (hemoglobin A present).
- Any condition or chronic illness, which in the opinion of the Principal Investigator makes participation unadvised or unsafe.
- Inability or unwillingness to complete baseline (pre-enrollment) studies, including blood or urine specimen collection, liver-spleen scan, abdominal sonogram, neurological examination, neuropsychological testing or Transcranial doppler (interpretable study not required, but confirmed velocity >200 cm/sec results in ineligibility).
- Previous or current treatment with HU or another anti-sickling drug.

#### Transient Exclusions

- Hemoglobin less than 6.0 gm/dL.
- Reticulocyte count less than 80,000/cu mm if hemoglobin is less than 9.0 gm/dL.
- Neutrophil count less than 2,000/cu mm.
- Platelet count less than 130,000/cu mm.
- Blood transfusion in the previous 2 months or HbA greater than 10%.
- ALT greater than twice upper limit of normal.
- Ferritin less than 10 ng/ml.
- Serum creatinine > twice upper limit of normal for age.
- Bayley Mental Scale standardized score below 70.

### **3.6.2 Eligibility Screening II**

Form 05 (Eligibility Screening II) is used to record the dates, specimen label numbers (see Section 7.2) or results of the tests and procedures required for the second stage of the eligibility screening process. (Information can be recorded on the form as it becomes available.) Some special studies require additional forms to be completed.

#### **3.6.2.1 Screening Tests**

The children of those parents who express interest in participation must undergo the pre-enrollment studies listed in this section. Children who are unable to complete these evaluations

cannot be enrolled in BABY HUG. These pre-enrollment evaluations will also serve as the child's baseline evaluations.

- Directed history and physical examination
- Local and central laboratory hematology blood specimen (including complete blood count, reticulocyte count, %HbF and F cells).
- Central Laboratory blood specimens
  - Biochemistry
  - Hemoglobin electrophoresis
  - Pitted cell count
  - Cytogenetics
  - DNA
  - Immunology
- O<sub>2</sub>% saturation
- Urinalysis, including urine concentrating ability
- Anthropometry: Height, weight and head circumference
- Neuropsychological evaluation (Bayley) and parent questionnaire (Vineland)
- Neurological examination and questionnaire
- Liver-spleen scan
- Abdominal sonogram (for gallstones, spleen size and kidney size)
- Transcranial doppler measurements (study must be attempted; interpretable study not required, but confirmed velocity >200 cm/sec results in ineligibility)

If a child fails a hematology transient exclusion criteria, subsequent blood specimens can be drawn and analyzed at either the local Clinical Center or Central Hematology Laboratory. If a child fails a biochemistry transient exclusion criteria, subsequent blood specimens can be drawn and shipped to the Central Biochemistry Laboratory. If repeat hematology or biochemistry specimens are sent to the Hematology and Biochemistry Central Laboratory, a new specimen label number should replace the existing label number on Form 05 and a new transmittal form should be completed. However, if a repeat hematology specimen is *only* being analyzed at the local (Clinical Center) laboratory, then the same label number should be used.

Once the child has met the anthropometric criteria, a drop below the 5<sup>th</sup> percentile in any growth parameter will not make the child ineligible. Any serious medical problems unrelated to sickle cell anemia, for example, leukemia or cerebral palsy or mental retardation, identified in the course of pre-enrollment evaluations (e.g., history and physical examination, complete blood counts, neuropsychological evaluations) will result in referral for appropriate medical care and ineligibility for BABY HUG.

### **3.6.2.2 Test Timeline**

The following special studies procedures can be performed in any order. However, once the first test is performed, the remaining procedures have to be performed within either one month or two months of the first test in order for the procedure to be valid for eligibility assessment. For example, if the liver/spleen scan is the first special study procedure done during screening, then all other special studies need to be performed within one month. Alternatively, if for example the TCD is the first special study performed and the anthropometrics are conducted two weeks later, then all remaining special studies need to be performed within the next month. But, if the liver/spleen scan or anthropometrics are done six weeks after the TCD, then all remaining tests need to be conducted within the next two weeks before the TCD 'ages out' of its two-month window. It is recommended that the 'one month' tests be performed at the end of the screening process to minimize the possibility of them 'aging' out.

#### Special Studies Valid for One Month:

- Liver/spleen scan
- Anthropometrics (height, weight and head circumference)

#### Special Studies Valid for Two Months:

- Bayley
- Vineland
- Neurological examination
- Abdominal sonogram
- TCD

### **3.6.3 MCC Review**

The MCC will schedule the eligibility assessment program to run on an hourly basis. The program will assess the responses to all inclusion/exclusion criteria and determine if all pre-



enrollment studies have been performed and reported. This assessment requires that the following forms are entered into the database as follows.

Forms keyed and passed edit

Form 04: Eligibility Screening I

Form 05: Eligibility Screening II

Form 06: History at Entry

Form 07: Demographics

Form 08: Growth History

Form 37: Local CBC Results

Form 40: Bayley

Form 41: Vineland Summary

Forms keyed

Form 43: Neurological Examination and Questionnaire

Form 44: Liver/Spleen Scan Performance

Form 45: Abdominal Sonogram Performance

Form 46: TCD Performance

Forms partially keyed (age-appropriate eligibility criteria correctly entered)

Form 42: Vaccination Record and Immunization Specimen Collection

The results of the eligibility assessment program are listed in the Eligibility Status Report, which is available under “Run Reports” on the Forms Entry page of the website (see Section 10.1). In addition, each time a Clinical Center requests the report for a patient, the eligibility assessment program will update the report for any additional information input via the screening forms or any of the related forms. If there are no ‘Hold’ conditions, no ‘Ineligible’ conditions, and all forms are entered into the database as required, the report will say that the child is eligible. The child can be randomized within one hour of being declared eligible, but eligibility will be good for two weeks unless the child will age out or a special study test will expire before the full two weeks has transpired. In this situation, the child must be randomized prior to the child or special study procedure aging out.

In addition to the Eligibility Status Report, global eligibility assessment information is given at the time the Clinical Center enters data for a child's Form 04 (Eligibility Screening I) or Form 05 (Eligibility screening II) and saves the form. Specifically, the database system will indicate if:

- The child fails a permanent or transient inclusion/exclusion criterion and is not eligible, or
- The child is on hold due to a response to one of the criteria, or
- The child's eligibility assessment is progress because responses have not been recorded for all inclusion/exclusion criteria.

**PEDIATRIC HYDROXYUREA PHASE III CLINICAL TRIAL (BABY HUG)  
MANUAL OF OPERATIONS**

**CHAPTER 4**

**RANDOMIZATION AND ENROLLMENT OF PATIENTS**

**4.1 RANDOMIZATION PROCEDURES**

The MCC staff maintain an Automated Telephone Response System (ATRS) for Clinical Center staff to use to request treatment allocations as eligible patients are identified. The MCC will randomly allocate a patient to hydroxyurea or placebo according to the Clinical Center's treatment allocation schedule. The ATRS system is accessible only to study personnel who enter the password for the Clinical Center and a personal identification number (PIN). A staff member at a Clinical Center can request treatment allocations for eligible patients after he/she has practiced using the ATRS, the Clinical Center has been certified, and the NHLBI has notified the Clinical Center that recruitment can be initiated.

Access to the ATRS is obtained by calling a toll-free telephone number at the MCC (see ATRS Worksheet, BABY HUG Form 20). The ATRS prompts authorized users by asking prerecorded questions; users respond by pressing keys on a touch-tone telephone. The prerecorded questions include confirmation that the patient meets all inclusion criteria and has no exclusion criteria, and that the patient's caregiver and the patient's physician have given informed consent for enrollment. Depending on the answers to these items, the next available treatment allocation is issued. The treatment kit number for that treatment allocation is given over the telephone by a prerecorded voice message and confirmed by fax transmission to the Clinical Center. The date and time of the completion of the call is the time of study entry for each patient. A computer record is maintained for each attempt to enroll a patient using the ATRS. If the Clinical Center fax machine is found to be inoperative after the call is completed, the investigator can call the ATRS again to request a second transmission of the kit number to the preprogrammed fax

number or to another fax number at the Clinical Center. At the time of the second phone call, patient identifying information must be entered before the treatment kit number is transmitted.

The steps required for a Clinical Center to be authorized to use the ATRS are:

1. Submit to the MCC a completed ATRS BABY HUG Clinic Application (see Exhibit 4-1).
2. MCC staff assign the Clinical Center a site number, a Personal Identification Number (PIN) and a Hospital Password (HP) and issue PIN cards with this information for the ATRS (see Exhibit 4-2). The PIN cards are sent to the Clinical Center by Federal Express. KEEP THE PIN CARDS CONFIDENTIAL.
3. At least one individual authorized to request allocations for a Clinical Center must complete a practice randomization prior to the Clinical Center being able to randomize patients.

#### **4.2 PRACTICE RANDOMIZATION FOR THE ATRS**

MCC staff have designed a system to allow authorized personnel to practice a few randomizations without actually entering a patient. The same procedures are used for this practice session as for an actual randomization except that: when you are requested to enter your Hospital Password, enter 9999 rather than the Hospital Password that has been assigned to your Clinical Center. The phone allocation system identifies this call as a practice session. The steps to complete a practice session are described below.

1. Before you begin, prepare an ATRS Worksheet (BABY HUG Form 20) with practice information and have your PIN card on hand. For the practice information, the Patient ID Number must be 99-99, patient eligibility must be answered Yes and signed informed consent must be answered Yes. Dial the toll-free number listed on the Form 20 (ATRS Worksheet). As soon as the call is answered, you are requested to enter your Personal Identification Number (PIN), and then the Hospital

Password. When you enter 9999 as the Hospital Password, the ATRS identifies the call as a practice session.

2. Follow the ATRS voice instructions as if a patient were actually being randomized. The practice session should be performed during working hours at the MCC, weekdays 9:00 a.m. - 4:00 p.m. (EDT or EST) so that problems can be resolved if they occur (call 410-435-0663).
3. At the end of the practice session, the system sends you a confirmation by FAX indicating the practice session came to a successful end. The FAX confirmation for the practice session clearly indicates that a patient has not been randomized. The receipt of this FAX shows that the accurate FAX number for your site is in the ATRS system.
4. The practice system will remain in place for the duration of the trial. If your staff periodically think that they need some practice using the system, or if new personnel have been assigned to request allocations, the practice system can be used for this purpose.
5. Each Clinical Center is expected to have at least one authorized individual perform a practice session prior to randomizing patients in the study. Each staff member who will randomize patients in the study must perform a practice session in order to activate their personal PIN number.

#### **4.3 HOW TO RESOLVE PROBLEMS WITH THE ATRS**

If there is no answer when you call the toll-free number, make at least two more attempts. If there is no answer, call the MCC toll number. If there is no response at the toll number, call the ATRS beeper number (see BABY HUG Form 20 - ATRS Worksheet).

After entering your five-digit PIN number, if the system responds: "That is not a valid number," check the small laminated PIN card to confirm that you used the correct PIN number. Dial the ATRS and try the PIN number again. If the second attempt is not successful, contact MCC

staff at the main number (410-435-0663) during normal working hours, or call the ATRS beeper number (see BABY HUG Form 20 - ATRS Worksheet).

If after entering your password the system responds: "I'm sorry, but you have not been certified for this application. To complete this requirement you must successfully complete the test procedure," staff at your Clinical Center have not performed a practice randomization. Perform a practice as described above in Section 4.2 using your PIN number and the practice password "9999."

If after entering your password the system responds: "The selected application is not available for your Clinical Center at this time," your Clinical Center has not been authorized by the MCC to initiate patient recruitment. In this situation you should contact the MCC to determine what documents have not been received.

EXHIBIT 4-1  
**AUTOMATED TELEPHONE RESPONSE SYSTEM  
BABY HUG CLINIC APPLICATION**

**Complete one form per clinic**

**Please TYPE or PRINT clearly!**

Date:	_____
Clinic Number:	_____
Principal Investigator:	_____
Clinic Name:	_____
Address:	_____ _____ _____
Clinic FAX Number:	area/country code ( ) _____
Clinic Voice Number:	area/country code ( ) _____
Pharmacy FAX Number:	area/country code ( ) _____
Pharmacy Voice Number:	area/country code ( ) _____
Time Zone: (Circle one)	Eastern Time    Central Time    Mountain Time    Pacific Time
Is Daylight Savings Time observed?    Yes    No	
Authorized Allocators:	
1 _____	5 _____
2 _____	6 _____
3 _____	7 _____
4 _____	8 _____
(Use back of sheet if additional space is required)	

**FOR COMPUTER SERVICES USE ONLY....**

\_\_\_\_\_ Date Completed:

\_\_\_\_\_ Completed by:

CLINIC PASSWORD Assigned:

PIN's Assigned:

1 _____	3 _____	5 _____	7 _____
2 _____	4 _____	6 _____	8 _____

**EXHIBIT 4 - 2  
SAMPLE PIN CARD**

**Pediatric Hydroxyurea Phase III Clinical Trial  
BABY HUG**

---

**Billie Jeanne Fish  
C-TASC**

**PIN: XXXXX  
XXXX  
Site: XX**

**03/12/03**

---

**Clinical Trials & Surveys Corp.**



# PEDIATRIC HYDROXYUREA PHASE III CLINICAL TRIAL (BABY HUG) MANUAL OF OPERATIONS

## CHAPTER 5

### STUDY TREATMENTS

#### 5.1 OVERVIEW

For children enrolled in BABY HUG and assigned to hydroxyurea (HU) treatment, hydroxyurea treatment will begin at a fixed dose of 20 mg/kg/day, and remain at this dose unless repeated or prolonged toxicity is encountered, in which case the dose will be reduced to a lower stable dose. The goal for dose adjustment is given in Exhibit 5-1. Patients will be maintained at 20 mg/kg/day or the lower stable dose for the duration of the 2-year period on blinded study treatment. Administration and monitoring of treatment in BABY HUG will follow all accountability and reporting requirements of the investigational new drug (IND) application accepted by the U.S. Food and Drug Administration (FDA) for use of hydroxyurea in BABY HUG.

Hydroxyurea will be formulated as a liquid preparation (100 mg/ml). Parents will be advised to administer treatment at approximately the same time each day (e.g., each morning or each evening before bedtime) to assist with compliance. All study medications (hydroxyurea and placebo) will be distributed by the Pharmacy Distribution Center in bottles of powder to the Clinical Centers. Each child's treatment supply will be formulated by the appropriate Clinical Center before the patient's scheduled visit.

Before each scheduled clinic visit, the Medical Coordinating Center will recommend a dose for the upcoming 2- or 4-week therapy period, and transmit this information electronically to the Clinical Center. On the day of the clinic visit (Day 1), the child will be weighed, examined, and monitored for toxicity. At each 2- or 4-week visit, the used bottle will be collected, and the family will be given a new bottle with an appropriately marked oral syringe. The instructions will be to continue therapy using the new bottle, unless they are told at the study visit or they receive a phone call to stop administering treatment. If a treatment had been stopped in the previous 2- or 4-week

period, a new bottle of study medication will be dispensed. The family will be instructed to start administering the study medication with the possibility that a phone call for a stop order may be issued within three days.

Blood specimens for routine study visits will be sent to the local Clinical Center laboratory for CBC determinations. Within one day of collecting the blood or by 9:00 a.m. eastern time of the following morning, the Primary Endpoint person will review local laboratory results for alert and toxicity values and data-enter the CBC values into the Internet Data Entry System. The MCC will also analyze the local CBC results. If the specimen is unusable (e.g. clotted), the Clinical Center staff will be given an opportunity to collect a second hematology blood specimen. However, the second hematology specimen must be collected within 48 hours of the first specimen. By Day 3, the Medical Coordinating Center will send out a recommendation for stopping or continuing study medication for the next 2- or 4-week period based on review of all blood counts received, study medication prescription history, toxicities and adverse reactions. The Clinical Center physician verifies that the recommendations and prescriptions are consistent on Day 3. When indicated, Clinical Center staff will notify families to “STOP” using the study treatment (if it is currently being administered). Failure to contact families to “STOP” using the study treatment can jeopardize patient safety. If appropriate efforts are made to contact a family with a “STOP” order, but the family is not contacted, the Clinical Center Principal Investigator will provide the Operations Committee with a written explanation of the reason contact could not be established and a plan to avoid inability to contact this patient in the future. If a family cannot be contacted for two “STOP” orders, the patient’s treatment will be interrupted until the Operations Committee assesses that it can be safely restarted.

Every six months at designated visits, which must occur on a Monday - Thursday, blood will also be sent to the Hematology and Biochemistry Core Laboratory by overnight courier, and arrive there early on Day 2. Within six hours of receipt of the blood, the Hematology and Biochemistry Core Laboratory will transmit hematology and biochemistry results to the Medical Coordinating

Center. No toxicities will be determined from the Core Laboratory results. However, the MCC will analyze the results for alerts and notify the Clinical Center Primary Endpoint Person of any alerts.

## **5.2 STUDY TREATMENT MANUFACTURER**

BABY HUG hydroxyurea and placebo study treatments are formulated at

UPM Pharmaceuticals, Inc.  
6200 Seaforth Street  
Baltimore, MD 21224

following current good manufacturing procedures (GMP).

After formulation of study treatments, UPM Pharmaceuticals, Inc., performs release testing for appearance of powder, reconstitution time, appearance of solution, active pharmaceutical ingredient content, preservative content and antimicrobial effectiveness. After release testing is passed, UPM Pharmaceuticals, Inc. issues certificates of analyses. After stability testing is passed, UPM Pharmaceuticals, Inc. issues a summary report with approval from the Analytical Department and the Quality Unit. After satisfactory reviews of materials manufactured and shipped, the NHLBI will direct release of study treatment for use in BABY HUG Clinical Centers.

## **5.3 PHARMACY DISTRIBUTION CENTER**

UPM ships the manufactured study treatments to the BABY HUG Pharmacy Distribution Center at:

Health & Human Services Supply Service Center (HHSSSC)  
HHS Supply Depot  
Building 14  
Perry Point, MD 21902

The Pharmacy Distribution Center (PDC) packages, labels and ships treatment kit boxes (six bottles, press-in-bottle-adapters and oral syringes per kit) to the BABY HUG Clinical Centers in accordance with the randomization schedule developed by the Medical Coordinating Center (See Section 4.1). The PDC will ship bottles of syrup for Clinical Center Pharmacy use in reconstituting study treatments.

## 5.4 CLINICAL CENTER PHARMACIES

All investigational drugs will be received, stored, inventoried, and dispensed only by the Clinical Center's Pharmacy. Guidelines for control of all investigational drugs shall be sufficient to meet the requirements of the U.S. Food and Drug Administration (FDA) and other pertinent regulatory bodies.

Upon approval of a treatment protocol by the local Institutional Review Board (IRB), a protocol file and notebook are created to include at least the following:

- a. Copy of the treatment protocol and future addenda and amendments;
- b. Study treatment information;
- c. Drug Accountability Records;
- d. Receipts and return records; and,
- e. Other correspondence.

Before dispensing an investigational drug to a patient, the pharmacist is responsible for at least the following:

- a. There is institutional and NHLBI approval for use of the drug ordered;
- b. There is official enrollment of the patient onto the relevant treatment protocol via physician order and/or copy of the signed informed consent;
- c. Insuring the physician is authorized to prescribe investigational drugs (Approved physicians records are maintained in the Protocol Office.); and,
- d. Worksheets for preparing the doses.

Medication orders for investigational drugs are processed in a similar fashion as other medication orders, for example, using unique computer entry for each investigational drug that is linked to the appropriate protocol. Entry of an investigational drug to a patient's profile on which that patient is not enrolled should result in an interruption of order entry prompting for intervention.

BABY HUG Clinical Center Pharmacies acknowledge receipt of study treatment kits by e-mail to the Pharmacy Distribution Center and MCC identifying the condition of each box received.

Drug Accountability Record forms are kept for each investigational drug. Each dose or quantity dispensed is signed out by protocol including unique patient identifiers, dose, quantity dispensed, continuous balance, lot number, and pharmacist identifying initials. The BABY HUG study treatment dispensing log (Exhibit 5-2) should be used for this purpose.

All doses of investigational drugs are identified as such with ancillary labeling.

Investigational drugs are to be provided only at BABY HUG Clinical Centers as ordered by authorized physicians and co-investigators (e.g., nurse practitioners or physician assistants who have legal status to prescribe); the dispensing or transfer of investigational drugs to non-BABY HUG physicians is prohibited. Investigational drugs may be sent to institutions affiliated in a Clinical Consortium (approved by the NHLBI) with a BABY HUG Clinical Center if written approval and FDA Form 1572 are on file in the main Clinical Center at the NHLBI, Medical Coordinating Center and FDA for the affiliated investigators. These drugs may be sent only pharmacy-to-pharmacy, in sealed containers complying with FDA regulations for transport of IND materials.

All investigational drugs dispensed are labeled with instructions for appropriate use as outlined in other sections of this manual.

In the event of an adverse drug reaction to an investigational drug, the adverse event reporting procedure should be followed (see Section 6.6.2). The National Heart, Lung, and Blood Institute (NHLBI) requires reporting to the Medical Coordinating Center of all Severe Adverse Events within twenty-four hours of occurrence to provide information necessary for reporting within the mandatory IND time frame.

Any questions or discrepancies in policy or procedures should be brought to the attention of a supervisor or the BABY HUG Clinical Center Pharmacist. BABY HUG Clinical Center pharmacists should contact the MCC to assure receipt of more kits or boxes of study medication as needed.

## 5.5 TREATMENT PREPARATION

An independent manufacturing facility prepares and ships bottles containing powdered hydroxyurea or placebo to the Pharmacy Distribution Center, which will forward these bottles, grouped as individual treatment kits, to each Clinical Center (Investigational) Pharmacy. Clinical Center pharmacists must be sure to tap adherent powder from bottle tops or sides before opening bottles for reconstitution. Bottles for each patient will be reconstituted with water and syrup by each Clinical Center (Investigational) Pharmacy to formulate the medications into liquid preparations. Hydroxyurea powder will be dissolved in syrup and water (see Exhibit 5-3) to achieve a final volume of 120 ml with a final concentration of 100 mg/ml. Placebo will be dissolved in an identically appearing and flavored solution. The study treatment will be dispensed in the bottle the powder arrived in with the child-proof safety-cap. Each Clinical Center (Investigational) Pharmacy will label it with the Patient ID Number, Patient Letter Code and instructions (including the "Investigational New Drug" warning, "BABY HUG Hydroxyurea Study for Sickle Cell Anemia", a prescription number, and the "emergency call" telephone number of the Clinical Center Principal Investigator). Inventory records for hydroxyurea and placebo will be kept by Pharmacy Distribution Center staff, and the Medical Coordinating Center will keep inventories of kit numbers used.

Several days before a patient's four-week visit, the Medical Coordinating Center staff will generate a prescription recommendation for the patient to be reviewed by a physician of the MCC (e.g., a consultant to the MCC) with a synopsis of recent blood counts. The MCC physician will check all prescription recommendations, and the MCC will notify each Clinical Center of the recommended prescription by e-mail. The Clinical Center (Investigational) Pharmacy will generate a label that includes the patient's dose with instructions on how to take the liquid. All verified prescriptions will be prepared by the Clinical Center (Investigational) Pharmacy, the bottles will be labeled appropriately, and the study treatment given to the family on the day of the patient's clinic visit. The Clinical Center (Investigational) Pharmacy will prepare a supply of the liquid formulation appropriate to the prescription, and dispense it to each patient with the appropriate dose marked

on the label and on syringes pouring off and documenting the disposition of excess liquid. The pharmacist will write the reconstituted expiration date (35 days from the date of reconstitution) on the BABY HUG label. A new bottle will be prepared for each study visit; the reconstituted study treatment should not be split and dispensed in multiple study visits. Any 'wasted' bottles (e.g., due to spillage, improper reconstitution procedures, etc.) should be reported on the Bottle Retirement Report (Exhibit 5-4) and faxed to the MCC immediately.

## **5.6 DEFINITIONS OF TOXICITY**

The most common toxicity observed in preliminary studies has been transient and reversible bone marrow depression. Hydroxyurea has only rarely been reported to be the cause of fever, skin rash, nausea, vomiting or hair loss. Such manifestations will be investigated locally and will be reported to the Food and Drug Administration (FDA) as adverse reactions if other etiologies are not apparent.

Toxic bone marrow depression is defined as an absolute neutrophil count < 1250/cu mm, absolute reticulocyte count < 80,000/cu mm (if the hemoglobin concentration is below 7 gm/dL), platelet count < 80,000/cu mm, a hemoglobin concentration < 6.0 gm/dL or >20% fall in hemoglobin concentration from the 3-month rolling average.

The following occurrences will also be defined as toxicity: unexplained gastrointestinal disturbance, unexplained rash or hair loss.

Toxicity levels are used for adjustment of study treatment dose and are distinct from alert levels which are used for clinical management of the child.

## **5.7 MONITORING FOR TOXICITY**

Patients will be seen at the Clinical Centers and will have blood sampled every two weeks until a stable dose is reached, then every four weeks thereafter. A few infants will be seen in peripheral clinics that are visited by the local PI every four weeks. Blood specimens for routine visits can be collected any day of the week provided blood is not also scheduled for collection and shipment to the Hematology and Biochemistry Core Laboratory which must occur on a Monday -

Thursday. If a patient misses the clinic visit, and the visit can be rescheduled within the extended visit window, the Clinical Center staff should complete the clinic visit (and blood collection) within the extended window. If a patient misses a visit that cannot be rescheduled during the extended window, the family will be advised to complete the available study medication (interrupting daily doses when the treatment runs out) and return in two weeks.

One pediatric tube of blood (0.5 ml) in EDTA will be obtained for a blood count including hemoglobin concentration, white blood cell count, platelet count, absolute reticulocyte count (ARC) and absolute neutrophil count (ANC). The local laboratory will perform automated (manual if automated is invalidated) CBC counts and the Primary Endpoint Person (PEP) will data enter them into the BABY HUG database via the Internet Data Entry System within one day of collecting the blood or by 9:00 a.m. the following day. An additional EDTA purple-top tube (0.5 ml) for hematology and a red-top tube (1.0 ml) for serum chemistries will be collected every six months and sent to the Hematology and Biochemistry Core Laboratory. No toxicities will be determined from the Core Laboratory results.

The PEP will review the local results to determine if a toxicity is present in the data. If there is a toxicity, the PEP will notify the Clinical Center staff of the need for a stop order. If there is not a toxicity, the PEP will open a previously delivered notice from the MCC that will instruct whether the PEP is to report a sham toxicity for the visit. Once reported, all other aspects of the reporting mechanism will be done in the same manner as if the toxicity is real (e.g., a meeting with ancillary staff, etc. to perpetuate the notion that the report is in fact a real toxicity).

In addition to the PEP review of the local laboratory results, the Medical Coordinating Center will scan the in-coming local laboratory reports for "toxic" results. If the specimen is unusable (e.g. clotted), the Clinical Center staff will be given an opportunity to collect a second blood specimen. However, the second specimen must be collected within 48 hours of the first specimen. If there are no local laboratory results, the Medical Coordinating Center will notify the Clinical Center of the need for a stop order. After MCC staff issue/confirm a stop order, they will notify the Clinical Center



coordinator, who will call the family and give the order to stop treatment if it has not already been done. The clinic coordinator and thus the family will be told to "stop treatment", without use of the word "toxicity." The coordinator will inquire concerning the child's health (e.g., regarding fever, lassitude, weakness). Parents (guardians) of any child whose condition is worrisome will be asked to bring in the child for an examination to rule out complications with potentially severe consequences such as parvovirus B-19 infection or splenic sequestration. Patient families will be notified of stop orders within 48 hours of the clinic visit. The child must then return for two week visits until the toxicity is resolved.

Medical Coordinating Center staff will provide the Clinical Centers with stop orders for placebo patients, in a similar manner as patients with toxicity due to HU. If the MCC physician(s) and other Medical Coordinating Center staff disagree on the toxicity evaluation, any stop orders, and/or the dose recommendation for the next therapy period, the laboratory results and treatment recommendation will be referred to the Study Chairman for immediate action.

## **5.8 DOSE TITRATION**

### **5.8.1 Hydroxyurea**

The Dose Titration Algorithm and the plan for dose reduction and toxicity monitoring in BABY HUG (Exhibit 5-1) is based on data obtained from HUSOFT (Wang et al, 2001). The starting dose of hydroxyurea will be 20 mg/kg (once a day, orally). If toxicity occurs (e.g., neutropenia), treatment will be stopped and blood counts will be checked every two weeks until they return to non-toxic values. Transient toxicity will not cause a dose reduction, but prolonged or repeated toxicity will. Following a toxic blood count, treatment will be discontinued for 14 days. If counts recover, treatment will be resumed at the previous dose. If toxicity persists, treatment will be stopped for an additional 14 days and treatment will resume at a daily dose 2.5 mg/kg lower than the previous dose once the toxicity is resolved. If that dose does not cause toxicity for eight weeks, an attempt will be made to increase the daily dose by 2.5 mg/kg; if toxicity occurs, the lower dose will be assigned as the stable dose. If transient toxicity occurs more than twice at the same dose

within a 12-week period, treatment will resume at a dose 2.5 mg/kg lower than the previous dose and continue for the duration of study. If blood counts reach the toxic range while on an established stable dose, treatment will be stopped until toxicity resolves and then treatment will resume with the previously established stable dose; repeated toxicity in a 12-week period will reduce the stable dose by 2.5 mg/kg for the remainder of the study.

### **5.8.2 Placebo**

Patients assigned to placebo will be given identically-appearing bottles containing placebo powder and the same flavoring as the HU-containing bottles. The placebo-containing bottles will be labeled identically to the HU-containing bottles. The Medical Coordinating Center will devise schedules of treatment STOPS and dose reductions and escalations for placebo patients based on the experience of bone marrow suppression, recovery, dose reduction and dose escalations seen in the open-label HUSOFT patients. Enough individual plans will be devised so that each of the children assigned to placebo in each Clinical Center will follow a different course of stops and dose changes that would just as readily occur in a child assigned to hydroxyurea. The goal of the plans is that the distribution of the final dose achieved among the placebo assigned patients will be similar to the final dose distribution among those assigned to hydroxyurea, and that the same proportion of children have treatment stops. This type of plan was implemented in the Multicenter Study of Hydroxyurea in Sickle Cell Anemia (MSH).

### **5.9 UNBLINDING**

In the Clinical Centers, the patients, their families, Clinical Center Principal Investigators, coordinators, and other study staff will be blinded to treatment assignments. The central event or image reviewers will not be able to link study treatment assignments to individual event reports or other outcome data. Medical Coordinating Center staff will have access to individual subject treatment assignment and current dose on a "need-to-know" basis, and will maintain records of each child's treatment assignment and current dose.

Plans have been made to prevent toxicity monitoring from resulting in unblinding of patients' assigned study treatments. Despite these precautions, if the Clinical Center Principal Investigator thinks he/she inadvertently has become unblinded, contact with the child and his/her family and clinical site staff must be carefully managed to avoid any comments regarding unblinding. The person who has the most patient contact, usually the coordinator, must be absolutely excluded from any contact with laboratory data. The Primary Endpoint Person (PEP), who monitors the local CBC evaluations for toxicity, will have access to information data about treatment assignment and must not share that information with the Principal Investigator or coordinator. In addition, the child's 3-month rolling average hemoglobin concentration will be provided by the MCC to the Clinical Center PEP every month for use with standard medical practice guidelines as needed locally.

The Clinical Center Principal Investigators have agreed to avoid seeking information that may unblind them with regard to individual treatment assignments, especially laboratory results. Clinical Center coordinators will conduct follow-up visits and process and maintain files of study documents. Study documents that contain potentially unblinding information (e.g., local lab reports, liver/spleen scan results, GFR results) will be maintained by the PEP. Although not preferred, Clinical Center Principal Investigators may be the primary care providers for BABY HUG children, and will be aware of the need to maintain blinding under normal circumstances and maintaining the child on study drug even during hospitalization. Discussion among Clinical Center staff or with families regarding a child's treatment assignment is inappropriate. Clinical Center coordinators must avoid any information that may unblind them.

Every family will be given an identification card describing the child's participation in the BABY HUG study, listing emergency study telephone numbers (e.g., the Clinical Center Principal Investigator's telephone number and the unblinding physician's emergency telephone number). The unblinding physician's "emergency call" telephone will be answered by a pediatric sickle cell anemia consultant to the Medical Coordinating Center. If BABY HUG children become ill, treating

physicians will be urged to call the Clinical Center Principal Investigator before altering the child's study regimen.

In an emergency, family members will be instructed to call a telephone number that will be manned by a pediatric sickle cell anemia consultant to the Medical Coordinating Center 24 hours a day. Arrangements will be made so that the child's study treatment assignment can be disclosed to the Clinical Center Principal Investigator after consultation between the Clinical Center Principal Investigator and the pediatric sickle cell anemia consultant to the Medical Coordinating Center. Reasons for unblinding are limited and are based on clinical grounds. Unblinding must be initiated by the Clinical Center Principal Investigator. Reasons for unblinding include overdose of the study medication, accidental ingestion of the study medication by another person, development of infection or bleeding that could be due to reduced white blood cell or platelet counts and for which management might be changed if the nature of the study drug were known. Examples of clinical situations when information on study treatment could be useful include severe thrombocytopenia calling for a decision to use prednisone versus platelet transfusion or severe neutropenia calling for a decision on choice of antibiotics. If a child's therapy is unblinded, the Clinical Center Principal Investigator or staff member who unblinded the treatment must send a report to the Medical Coordinating Center. In addition, if unblinding is due to a study treatment overdose, the child's CBC, ALT, reticulocyte count and creatinine values must be reported to the MCC.

Each Clinical Center is encouraged to assign another non-BABY HUG hematologist and nurse practitioner to be available for acute care visits. The Clinical Center coordinator will have the most contact with patients and families and will be excluded from contact with laboratory data collected during acute events. The Primary Endpoint Person will, however, have access to a patient's 3-month rolling average hemoglobin value every month, which will be provided by the MCC for use in evaluation of anemia. Unblinding will occur only after consultations between the Clinical Center Principal Investigator and an external, study Pediatric Hematologist consultant. Unblinding events will be discussed in the Operations Committee and may result in discontinuing

study treatments. However, all patients, including those whose treatments have been unblinded, will continue to be followed in BABY HUG for safety outcomes and clinical outcomes not already declared at the time of unblinding. Since analysis will be conducted according to the principle of Intention to Treat and unblinding is expected to occur infrequently, the impact of unblinding is anticipated to be less than that of possible crossovers.

#### **5.10 TREATMENT INTERRUPTIONS**

There may be instances related to medical conditions (e.g., acute, intercurrent illnesses such as an infection) or other reasons (e.g., study medication is lost by the family or “STOP” orders cannot be delivered) when it may be advisable to interrupt study therapy without unblinding. Interruptions for medical conditions should be allowed only with consultation of the Clinical Center Principal Investigator. The Clinical Center Principal Investigator is responsible for notifying the Medical Coordinating Center of treatment interruptions. These notifications are important because they may in turn have an influence on dose titration.

#### **5.11 ASSESSMENT OF COMPLIANCE**

Study treatment (usage) will be measured by the Clinical Center pharmacist at each regular follow-up visit. The Clinical Center (Investigational) Pharmacy must keep the last returned bottle until the next study visit. If the volume of study treatment remaining in the bottle is not consistent with the prescribed dosing plan, staff will inquire about any difficulties that may have occurred. The importance of compliance will be emphasized for all patients. Even if patients are repeatedly considered to be non-compliant, they will continue to be followed and will continue to receive their study reimbursements (i.e., travel/telephone allowances).

#### **5.12 MISSED VISITS AND DROP-OUTS**

Each regularly scheduled clinic visit missed by a patient (e.g., the visit window has closed for routine study visits) will be reported to the Medical Coordinating Center. Families who do not wish to continue attending clinic visits in the BABY HUG study will continue to be telephoned by the Clinical Center coordinator to ascertain the medical condition, any identifiable events and vital

status. Attempts will be made to obtain semi-annual and annual evaluations for all study participants.

### **5.13 DURATION OF STUDY TREATMENT**

The goal of the study treatment plans will be to maintain patients on the assigned medication until the end of the 24-month period and on the maximum non-toxic dose of study treatment for at least 18 months of the two-year trial period.

### **5.14 INVESTIGATIONAL NEW DRUG**

The U.S. Food and Drug Administration (FDA) has assigned IND Number 67,289 for the National Heart, Lung, and Blood Institute (NHLBI) Investigational New Drug application for BABY HUG. All Clinical Center activities must be performed in BABY HUG in a manner consistent with the requirements of IND regulated treatments.

The Clinical Center (Investigational) Pharmacy must keep the last returned bottle with the remaining study treatment until the next study visit. Older bottles must be destroyed with their destruction documented according to standard pharmacy procedures for IND reporting.

## EXHIBIT 5-1

### PEDIATRIC HYDROXYUREA PHASE III CLINICAL TRIAL (BABY HUG)

#### DOSE TITRATION ALGORITHM

Goal: To treat at 20 mg/kg/day or a lower, stable dose, defined as the highest dose maintained for eight weeks without observed blood count toxicity; and to maintain the patient at stable dose thereafter.

Titration Phase (visits every 2 weeks):

1. Begin hydroxyurea at a dose of 20 mg/kg/day.
2. Continue treatment and monitor for toxicity.
3. If toxicity develops:
  - a. A stop order is issued, and the patient will have repeat blood counts performed every 14 days until toxicity resolves.
  - b. If the toxicity resolves at 14 days, then the study drug will resume at the pre-toxic dose. If the toxicity requires more than 14 days to resolve, then the daily dose will be lowered by 2.5 mg/kg. A patient must take a prescribed dose before a lower subsequent dose will be prescribed. (i.e., toxicities that require more than 14 days to resolve will have the dose reduced 2.5 mg/kg from the last dose that was actually administered to the patient).
  - c. As long as the patient does not become toxic over the subsequent eight-week period on the lower dose, the daily dose will be increased by 2.5 mg/kg not to exceed 20 mg/kg/day.
  - d. If a patient becomes toxic at any given dose twice in a 12-week period, no further increases will be made. The highest dose that does not produce toxicity for an eight-week period is designated the stable dose.
4. No patient will receive more than 20 mg/kg/day.

Stable Dose Phase (visits every 4 weeks):

1. If the patient becomes toxic after the stable dose is established, a stop order is issued and the study drug is stopped. When the toxicity resolves, the study drug will be resumed at the pre-toxic stable dose. If toxicity recurs within a 12-week period, the stable dose will be lowered by 2.5 mg/kg.

**EXHIBIT 5-2**

**BABY HUG DISPENSING LOG**

Page \_\_\_ of \_\_\_

Name of Institution:	Clinical Center #:
Agent Name: Hydroxyurea/Placebo	Dose Form and Strength:
Protocol Title: Pediatric Hydroxyurea Phase III Clinical Trial (BABY HUG)	Dispensing Area:
Investigator Name:	
Patient ID #:	Treatment Kit #:

Line No.	Date	Dose	Volume Dispensed	Qty Disp	Balance Fwd Balance	Bottle Number	Lot No.	Recorder's Initials	Volume Returned*
1.									
2.									
3.									
4.									
5.									
6.									
7.									
8.									
9.									
10.									
11.									
12.									
13.									
14.									
15.									
16.									
17.									
18.									
19.									
20.									
21.									

\*Record the volume returned for the bottle number dispensed on this line.



### EXHIBIT 5-3

#### PEDIATRIC HYDROXYUREA PHASE III CLINICAL TRIAL (BABY HUG) STUDY TREATMENT RECONSTITUTION DIRECTIONS

1. Tap adherent powder off top or sides of bottle.
2. Add 70 ml of Purified Water into the bottle containing drug powder blend. Shake well for at least 2 minutes.\*
3. Add 40 ml of Simple Syrup into the same bottle. It is very important that the syrup be added soon after (i.e., no more than 2 minutes) the addition of the purified water. Shake well for at least 3 minutes before use.
4. Refrigerate reconstituted solution at 6.4° C or higher.

\*Total (purified water and simple syrup) shaking time may exceed five minutes for complete dissolution on occasion. Please check solution for complete dissolution after shaking. If particulate matter remains, resume shaking until complete dissolution is achieved. All volume (purified water and simple syrup) is needed for complete dissolution.

**EXHIBIT 5-4**  
**BABY HUG STUDY TREATMENT**  
**BOTTLE RETIREMENT REPORT**

Today's Date:

			-			-				
Month			Day			Year				

Clinical Center:

--	--

Pharmacist:

---

Pharmacist Phone Number:

			-				-			
--	--	--	---	--	--	--	---	--	--	--

Pharmacist email:

---

Patient ID:

--	--	--	--

Study Treatment Kit Number:

K			
---	--	--	--

Number of bottles retired:

--	--

Number of bottles remaining:

--	--

Date bottles were retired:

			-			-				
Month			Day			Year				

Reason for retirement:

- Bottle spilled prior to reconstitution
- Bottle spilled after reconstitution
- Bottle incorrectly reconstituted
- Reconstituted bottle not dispensed due to stop order
- Reconstituted bottle not dispensed because patient missed visit
- Other (specify): \_\_\_\_\_

Retired bottles destroyed:

Yes  No

*Please FAX completed form to.*

**Renee Rees**  
**BABY HUG Medical Coordinating Center**  
**443-524-2320 (FAX)**



**PEDIATRIC HYDROXYUREA PHASE III CLINICAL TRIAL (BABY HUG)  
MANUAL OF OPERATIONS**

**CHAPTER 6**

**CLINICAL CENTER PROCEDURES**

**6.1 SCHEDULING**

Scheduling of study visits and tests may be unique to each patient – based on their time line, age, location in relation to your clinical center, policies at your institution, NPO status, etc. Visits for baseline and exit testing will present the biggest challenges.

**6.1.1 General Principles for Scheduling Baseline and Exit Tests**

- The only test requiring NPO status (no food or fluids by mouth for a specified length of time before the test) is urine concentrating ability. This test should ideally be done in the morning – because withholding foods and fluids may make the child hungry and unhappy. The biochemistry specimen should be drawn approximately the same time as the collection for the urine concentrating ability. Abdominal ultrasound requires a period of “clear liquids only” for six hours before the test. When possible, the urine concentrating ability and biochemistry specimen collection should be done on the same day as the abdominal sonogram to minimize the number of visits that require restricted fluid/food intake.
- The liver-spleen scan and DTPA assessment of glomerular filtration rate (GFR) are nuclear medicine procedures using radioisotopes; most nuclear medicine departments recommend at least 72 hours between these tests. The liver-spleen scan must be completed prior to randomization and at least three days before you anticipate treatment initiation.
- Baseline blood draws should be spaced as necessary; a general guideline for research blood draws is no more than 3cc/kg/8 weeks. When possible, blood draws should be grouped around IV starts in order to minimize the number of times the

child is subject to needle insertion. Another reason to do this is that blood for pitted cell counts (part of screening blood work) should be drawn at or close to the time the liver-spleen scan is performed.

- Neuropsychological testing, the neurology exam, and TCD should be done when the child is alert and not hungry, for maximum attention and cooperation.
- Keep in mind that some of these tests may require 4-6 weeks advance scheduling in some institutions; therefore, it will be important to always plan ahead for these study patients.
- The liver/spleen scan and anthropometrics should be scheduled toward the end of the screening process since their results are valid only for one month.

### 6.1.2 Sample Schedule for Baseline Testing

Below is a sample schedule for baseline testing; however, many combinations are possible and acceptable.

- |              |   |
|--------------|---|
| Visit/Day #1 | <ul style="list-style-type: none"><li>• Neuropsych testing</li><li>• Neurology exam</li><li>• O<sub>2</sub> saturation</li><li>• Blood draw for Hematology (0.5ml)</li></ul>  |
| Visit/Day #2 | <ul style="list-style-type: none"><li>• Child NPO after midnight</li><li>• Collect urine sample for urinalysis and urine concentrating ability</li><li>• Collect blood samples for Biochemistry (2.0 ml), and Immunology (3.5ml)</li><li>• Abdominal Sonogram</li></ul> |
| Visit/Day #3 | <ul style="list-style-type: none"><li>• With IV start for liver/spleen scan, collect blood for Cytogenetics (4ml), VDJ (3ml) and Pitted Cells (0.1 ml)</li><li>• Anthropometry</li><li>• TCD</li></ul>  |

### **6.1.3 Study Treatment Initiation Visit**

Treatment initiation can begin the same day as randomization, but must begin within two weeks of randomization. The renal GFR/DTPA clearance study will occur coincident with giving the first treatment dose. For statistical reasons, the time between randomization and treatment initiation should be kept to a minimum. Thus, ideally the nuclear medicine department is contacted and scheduled for the DTPA study, and then the child is randomized a day or two before the scheduled DTPA and treatment initiation visit. In addition, the DTPA study (and thus the treatment initiation visit) should be scheduled at least 72 hours after the liver-spleen scan to allow for clearance of the radionuclide used for the scan.

### **6.1.4 Weekly and Monthly Visits**

Routine visits, for blood work and dispensing of drug, will be scheduled every 2 weeks until the child reaches his/her stable dose and then every 4 weeks until study exit. These visits are also known as “blood-drug” visits. They may be scheduled any day of the week provided there are no central blood specimens to be collected (i.e., every 6 months after treatment initiation) which can only be collected Monday - Thursday. Routine visits should ideally be scheduled for the specific week the child is due (02, 04, 06, 08, etc.); however, the study allows for some flexibility in scheduling these visits (see Section 6.2.3.1) so that a child may come in on the off weeks (03, 05, 07, 09, etc.) and still remain on schedule with their visits and have enough study drug at all times. When completing forms for these visits, it is important to record the week number during which the visit is actually completed rather than the week number it was originally scheduled.

Monthly visits, which are for special tests and procedures, will occur every 3 months throughout the study. They may or may not coincide with a scheduled “blood-drug” visit. As with routine visits, monthly visits may be scheduled any day of the week; however six month visits require central blood specimens to be collected and thus must be scheduled Monday - Thursday. Again, these visits should ideally be scheduled for the specific week the child is due; however, the study allows for some flexibility in scheduling these visits (see section 6.2.3.2) so that a child may

come in on the off weeks and remain on schedule with their visits. When completing forms for these visits, record the month the visit was originally scheduled for the exam if the child came in on an off week. For example, at 12 months, the child will have a routine weekly visit for blood work and dispensing of study treatment, and a monthly visit for neurocognitive, neurological and TCD testing, as well as have Central Hematology and Biochemistry blood specimens drawn.

### **6.1.5 Study Exit Visit at 24 Months**

The specimens to be collected and the special studies to be performed for a child's study exit visit at 24 months (24M visit) are outlined in Appendix A of the Protocol.

The 24M visit has a 5-week extended window with the middle of the window centered on the child's 2 year anniversary date (see section 6.2.3.2). All of the exit study procedures must be conducted within that five week window. A child must remain on study treatment until the liver spleen scan and the DTPA GFR test are performed. The sequence of the two tests should be to perform the liver spleen scan before the DTPA GFR. Treatment should be discontinued after performance of the DTPA GFR test. Therefore, if possible, the DTPA GFR test should be the last of all of the required tests carried out on the child.

If you cannot arrange for the DTPA GFR test to be the last test performed, make sure that any other required tests are carried out within 2.5 weeks of the completion of the DTPA GFR or the end of the 24 month visit window, **whichever comes first**. Any test not done before this time should not be collected and an appropriate missed procedure form should be filled out.

You must adhere to the data/specimen collections for routine study visits while the 24M visit is being carried out. If you can use data collected during a routine study visit ( e.g., anthropometrics or local laboratory data) as 24M data, this is allowed, but the data should be entered on both the routine study visit forms and the 24M study forms. By separating data collection in this way, the computer system will properly process the child's data. All of the 24M assessments are to be documented on the 24M forms (Forms 36, 22, 40, 41, 43, 44 and 46). Standard study visit forms

(Forms 31 and 37) should be used to collect any required information from the routine study visits that must be carried out during the 24M window.

Local and Central CBC results will be collected over this five-week interval. The central CBC need only be collected once in the five-week interval. The standard visit schedule requires you to collect a local CBC blood specimen each time a routine study visit is carried out in this five-week interval. If you use a hematology blood collection for both a 24M data collection, and a regular study visit data collection, enter the data twice – once using a 24M visit number and once using the routine study visit week number.

Depending on the day of the week of the child's two-year anniversary, the 5 week window generally begins between weeks 101 and 102 and ends between weeks 106 and 107. Figure 6-1 shows an example of how the visits, data collection and special studies can be carried out over the five-week interval. In this example, we have grouped procedures together in a way that will make the statistical and clinical analyses of the data the most meaningful. You are encouraged to try to adhere to this schedule because it will yield the most clinically meaningful data. However, this is a goal and not a requirement. If you cannot get everything done using the study template, spread the procedures out and/or vary the order of the procedures to meet the family's and Clinical Center Staff's needs. Completion of all of the procedures/data collection in the five-week window is the only thing that will be monitored by C-TASC staff.

The current visit schedule for a child will have the child's last routine visit occurring at week 100 or week 102, depending on when the child started stable-dose study treatments. It may be possible that the child will not complete all exit studies within four weeks of the current projected last routine study visit (and hence run out of study treatment). C-TASC staff have modified the Appointment Schedule such that Clinical Center staff can print out a new schedule that contains an "optional" routine study visit. Optional routine study visits are denoted by an '(O)' to the left of the week number (104 or 106, but not both) on the new Appointment Schedule (please reprint the child's visit schedule if you think you will need the additional routine study visit to complete the 24M



data collection). The extended window for the optional visit will not extend beyond the 5-week window for the 24M visit. A Form 31 and 37 must be completed for the optional routine visit.

If you must break things up, please use the guidelines in Exhibit 6-1 to guide you in your data collection efforts.

**Figure 6-1**  
**SAMPLE VISIT SCHEDULE FOR COLLECTION CLOSE-OUT DATA**

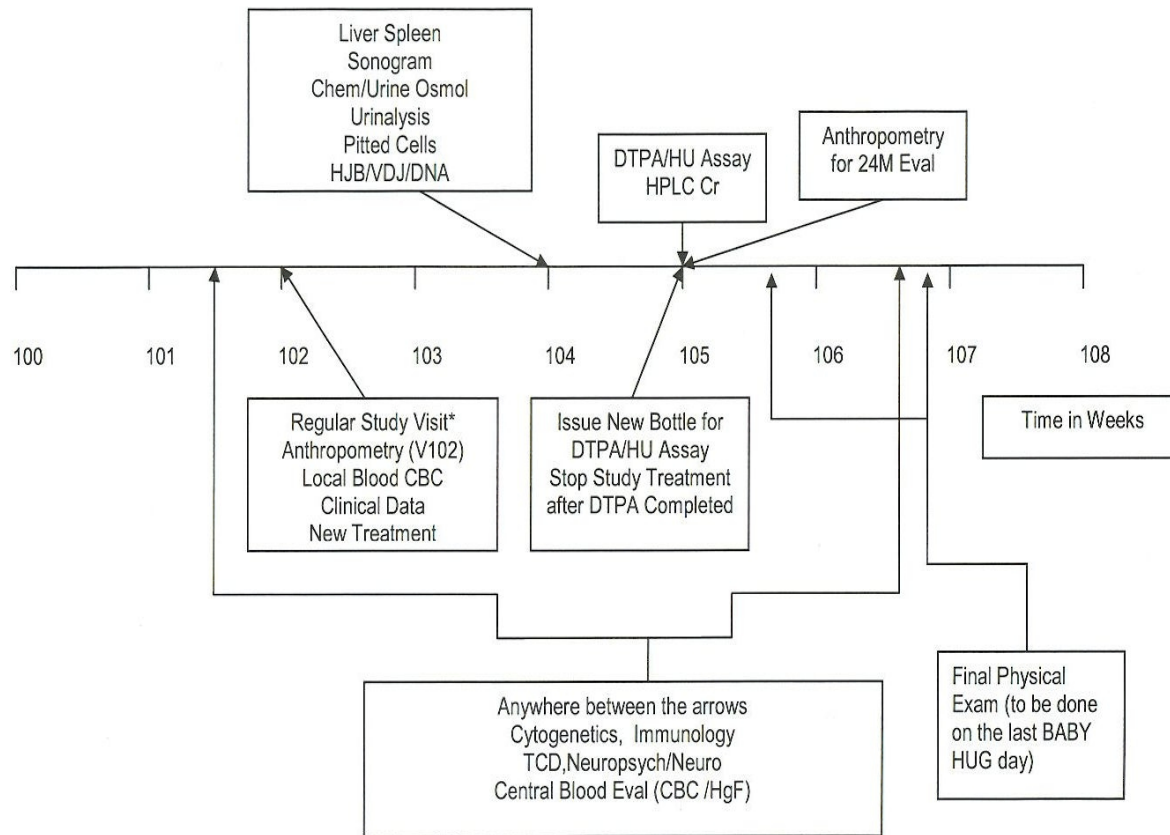

\* This visit may not be required if you can complete all exit tests/procedures prior to the next scheduled regular study visit. The placement of the visit may shift based on the visit schedule that has been established for the patient. You may also have to perform two visits depending on when the first routine study visit begins within the five-week window.

## **6.2 VISIT SCHEDULE, EXPECTATION, AND DATA COLLECTION**

### **6.2.1 Visit Types and Numbering**

There are several types of study visits for BABY HUG, and each type is numbered differently:

- Screening or baseline visits, which are for collecting data and completing screening tests. These visits are all numbered as 00M.
- Treatment Initiation, which is for administration of the first dose of study drug and DTPA assessment of GFR. This visit is always numbered 000.
- Weekly visits, which are for blood work and dispensing new study drug (AKA “blood and drug visits”). These visits are numbered according to number of weeks the child has been in the study (002, 004, 006, 008, 012.....).
- Monthly visits, which occur every quarter, are for special tests and procedures. These visits are numbered according to the number of months the child has been on study (03M, 06M, 12M, 18M.....).

The “sequence number” will generally fill-in automatically during data entry. It will not for forms that can have multiple submissions in a visit window or visit week.

### **6.2.2 Schedule of Expected Visits**

The expected study visits and testing for each child are listed in Appendix A of the Protocol.

A summary of those visits (for an ideal schedule) follows:

- Baseline Testing (which may be one admission or several visits)
- Treatment Initiation (one visit)
- Weeks 2, 4, 6, 8.....(visits every 2 weeks until the child is on stable dose of study drug)
- Weeks 12, 16, 20, 24, 28, 32, 36, 40, 44, 48, 52, 56, 60, 64, 68, 72, 76, 80, 84, 88, 92, 96, 100, 104 (visits every 4 weeks on study treatment until study exit)
- Months 03, 06, 09, 12, 15, 18, 21

- Exit Testing (24M, or sooner if the child drops out; may be over one admission or several visits)

### **6.2.3 Visit Windows**

All visit windows are generated based on a child's treatment initiation date. The visit windows will not change during the course of the study, but there is some flexibility as to when the visit can occur before the visit is declared as "missing". When the child is not affected by toxicity, all attempts should be made to schedule the child's visit during the Ideal Window, which is comprised of an Earliest Date and a Latest Date. A visit during the Extended Window is acceptable, but attempts should be made to get the child back "on schedule." If a child becomes toxic in the first two weeks of a 4-week cycle, additional weekly visits will be added.

#### **6.2.3.1 Weekly Visits**

The Ideal Window for all weekly visits (2-week cycle and 4-week cycle) is Monday through Sunday of the first week in the cycle. The Extended Window extends the Ideal Window to the last Sunday in the weekly cycle. Thus, the Extended Window for a 2-week cycle will extend for an additional seven days beyond the end of the Ideal Window, whereas for a 4-week cycle, the Extended Window will extend for an additional 3 weeks beyond the end of the Ideal Window.

#### **6.2.3.2 Monthly Visits**

The Ideal Window for all monthly visits is 7 days. The Extended Window is five weeks - comprised of the 2 weeks prior to the Ideal Window, the Ideal Window, and the 2 weeks after the Ideal Window.

### **6.2.4 Website Reports**

The BABY HUG website contains several different types of reports to assist with patient visits and scheduling.

The "Appointment Schedule" report lists all visits for each patient throughout the study. It specifies earliest and latest dates for the visit to be scheduled and leaves an area to record the "actual" visit date. The schedule will remain constant until the child migrates from 2-week visits to

4-week visits, at which point the schedule will be updated on the website. If an additional 2-week visit needs to be inserted in the 4-week schedule due to a stop order on the previous visit in the 4-week cycle, a revised visit schedule for the child will be posted to the website. To access the report,

1. Click on “Forms Entry”
2. Click on “Reports”
3. Click on “Appointment Schedule” and click “OK”
4. When prompted, type a specific Patient ID and click “OK”
5. When prompted for a password, type “BABYHUG” (all caps)
6. A list showing Patient ID and visit date ranges will be displayed.

The “Expected Visits” report lists all visits for your site in a particular month, with specific dates and ranges. It also specifies the forms due at each visit. To access the report,

1. Click on “Forms Entry”
2. Click on “Reports”
3. Click on “Expected Visits” and click “OK”
4. Choose a specific month from the pull-down menu and click “OK”
5. When prompted for a password, type “BABYHUG” (all caps)
6. A list showing Patient ID, week/month on study, visit date ranges, and forms to be completed will be displayed.

### **6.2.5 Forms Linked to the Visit Schedule**

There are 29 study forms for this study on the website. Below is a list of each form by number and title and a brief description of when and by whom they should be completed.

<b>Form</b>	<b>Form Title</b>	<b>When Completed</b>	<b>By Whom</b>
01A	Patient Information Form	Baseline Visit – 00M	PI/Coordinator
04	Eligibility Screening I	Baseline Visit – 00M	PI/Coordinator
05	Eligibility Screening II	Baseline Visit – 00M	PI/Coordinator
06	History and Physical at Entry	Baseline Visit – 00M	PI/Coordinator
07	Demographics and Household	Baseline Visit – 00M	PI/Coordinator
08	Growth History	Baseline Visit – 00M	PI/Coordinator
20	Request for Randomization	Randomization	PI/Coordinator
21	Treatment Initiation Visit	Treatment Initiation 000	PI Coordinator
22	DTPA and HU Assay	Treatment Initiation 000	PEP
23	HU Assay at 1 Month Post-Treatment Initiation	004	PI/Coordinator
31	Study Visit	Weeks: 02, 04, 06, 08, (until on stable dose)12, 16, 20, 24, 28, 32, 36, 40, 44, 48, 52, 56, 60, 64, 68, 72, 76, 80, 84, 88, 92, 96, 100, and 104	PI/Coordinator
32	Missed Visit	Any missed visits for weeks: 02, 04, 06, 08, 12, 16, 20, 24, 28, 32, 36, 40, 44, 48, 52, 56, 60, 64, 68, 72, 76, 80, 84, 88, 92, 96, 100, and 104 Also for missed Monthly Visits: 03M, 06M, 09M, 12M, 15M, 18M, 21M, 24M	PI/Coordinator
33	Quarterly Visit	03M, 09M, 15M, 21M	PI/Coordinator
34	Six/Eighteen Month Visit	06M and 18M	PI/Coordinator
35	Twelve Month Visit	12M	PI/Coordinator
36	End of Randomized Treatment	24M (or earlier if dropout)	PI/Coordinator
37	Local CBC Results	Any local labs drawn at a study visit or any unscheduled visit (e.g., ER Visit) that results in a toxicity	PEP
38	Hold Restart	When receive IRB approval to restart study	PI/Coordinator
40	Bayley	Baseline (00M), 12M and 24M	Neuropsychologist and PI/Coordinator
41	Vineland	Baseline (00M), 12M and 24M	Neuropsychologist and PI/Coordinator
42	Vaccine Record/ Immunology	Update every visit	PI/Coordinator
43	Neurology Exam	Baseline (00M), 12M and 24M	Neurologist and PI/Coordinator
44	Liver Spleen Performance	Baseline (00M) and Exit	Nuc Med Tech and PI/Coordinator
45	Abdominal Sonogram	Baseline (00M) and Exit	Sonogram Tech and PI/Coordinator
46	TCD Performance	Baseline (00M), 12M and Exit	TCD examiner and PI/Coordinator
50	Reportable Event and/or Hospitalization	Any adverse event	PEP
64	Treatment STOP Order	Any local or MCC issued STOP order	PI/Coordinator
65	Restart Treatment Order	Any restart occurring before a clinic visit	PI/Coordinator
66	Study Treatment Dosing Irregularity	Any dosing irregularity	PI/Coordinator
80	Additional Information	Any applicable occasion	PI/Coordinator

## **6.3 MAINTENANCE OF STUDY RECORDS**

### **6.3.1 Patient Records**

Study-related patient records must be kept in lockable cabinets or file drawers, preferably in the Study Coordinator's office (blinded data) and the Primary Endpoint Person's office (unblinding data). The study does not mandate a specific system of patient record filing. Thus, each coordinator should develop a well-organized filing system that optimizes the ability to easily retrieve specific files. For example, the coordinator can use a single large 3-ring binder for each patient with the Patient ID number on the outside binding. The material is sorted in the binder using labeled dividers. Another system that may be chosen uses hanging dividers in a file drawer labeled with the Patient ID number, each containing labeled folders that sort specific information.

#### **6.3.1.1 Coordinator Files**

Material contained in the patient files that are maintained by the coordinator should include, but are not necessarily limited to, the following:

- Signed original consent forms
- Signed original HIPAA forms (if not incorporated in consent form)
- Family contacts (e.g., written correspondence or memos documenting telephone communications)
- Receipts and reimbursement records related to family expenses associated with the study
- Contact documentation regarding ombudsman involvement, including letters, faxes, memos and emails
- Past medical history documents, such as birth records, disease-related events, discharge summaries, growth data points, and immunization records
- Randomization confirmation notice with treatment kit number
- The child's appointment schedule

- All study form index documents that do not contain potentially unblinding data (see Section 6.3.1.2). Each study form MUST have an index document. The index document can be either the original paper form completed before entry in the BABY HUG database via the Internet or it can be the first printout of the study form. All modifications to the study form must be properly recorded on the index document.
- Copies of abdominal sonogram films (hard copy and/or digital)
- Copies of neuropsych evaluations
- The child's growth charts
- Current medical records (e.g., neurological exam narratives) except laboratory results
- Copies of specimen and film transmittal forms

#### **6.3.1.2 PEP Files**

The PEP must maintain all study-related patient records that contain potentially unblinding data. These materials include:

- Documentation of clinical events occurring while the patient is on study, including Form 50 and Form 80
- Local laboratory results beginning with treatment initiation
- Copies of baseline and exit liver/spleen scans (hard copy and/or digital)
- Baseline and exit DTPA measurements
- Index study forms and all printouts for Forms 22, 37, 44, 50

#### **6.3.2 Clinical Center Records**

The study coordinator should also designate a bookshelf or desktop space to keep a collection of binders of study materials, including:

- Protocol, with all amendments
- Manual of Operations
- Forms
- QxQ's



- Address Directory
- Numbered Memos
- Operations Committee/Steering Committee Minutes
- Correspondence
  - With other coordinators
  - Coordinator conference call minutes
  - With the coordinating center
- Study Newsletters
- Specific Clinical Center Requirements
  - IRB and other administrative (e.g., Radiation Safety, Scientific Devices) materials and approval documents
  - Local consent form
  - Advertising materials
  - Clinical Center applications (ATRS, website site and individual)
  - FDA Form 1572 and respective CV's
  - Financial Disclosures
  - Certifications
  - Pharmacy information
  - Local special study performance directions and notes (e.g., GFR, TCD)

## **6.4 TRANSFER OF BABY HUG PATIENTS**

### **6.4.1 Notification of Transfer**

If a patient moves from one BABY HUG Clinical Center to another BABY HUG Clinical Center, the Study Coordinator of the original Clinical Center will discuss the pending transfer with the patient. The Study Coordinator will provide the patient with the address and telephone number of the new Clinical Center as well as contact information for the Principal Investigator, Study Coordinator and Patient Family Advocate.

The transfer of a BABY HUG patient from one Clinical Center to another will be treated as a physician to physician referral for a research patient. A memo and PART I of Form C: Notification of Patient Transfer (Exhibit 6-2) must be completed by the original Clinical Center's Principal Investigator and sent to the Principal Investigator of the new Clinical Center informing him/her of the potential transfer. This will serve as a formal notice to the new Clinical Center that a patient is transferring. The memo should include:

- A. An explanation of transfer and support as to why the patient should continue in the BABY HUG study
- B. Approximate date the patient is scheduled to move
- C. Date of the last study visit, the last visit number completed, an appointment schedule and study visit treatment to be dispensed at the upcoming visit
- D. A medical summary and other pertinent source documents
- E. Patient's new address, telephone number and other relevant contact information. The patient's family should also provide contact information for a relative not residing in their household.

The new Clinical Center's Study Coordinator, Research Pharmacist, Patient Family Advocate and Primary Endpoint Person should also receive a copy of this memo. The MCC should receive a faxed copy of Form C. The Principal Investigator at the original Clinical Center should also contact the new Clinical Center's Principal Investigator by phone to discuss all medical aspects of transfer.

#### **6.4.2 Release of Medical and Study Records**

Once a Clinical Center becomes aware of a patient's intent to transfer to a new Clinical Center, they may request that the patient's family sign a medical records release form. The form must contain the name of the patient, the signature of the parent and the party to which the patient's

medical information is to be released. The medical records, study documentation and labels must remain at the original Clinical Center until the patient's family completes a medical release form.

The Principal Investigator at the original Clinical Center should forward the patient's medical records to the Principal Investigator at the new Clinical Center after the medical release form is signed. A copy of the patient's consent form, medical records and medical record abstractions should be sent to the new Clinical Center as soon as possible, prior to the patient's first scheduled appointment at the new Clinical Center.

The original Clinical Center will retain the patient's original BABY HUG records and send the new Clinical Center copies of all documents on file. The Study Coordinator at the original Clinical Center should clear all edits prior to the transfer of the patient. The patient must retain the original BABY HUG patient identification number throughout the course of the study, even though it was assigned at the original Clinical Center.

The original Clinical Center's Primary Endpoint Person will forward copies of study documents containing potentially unblinding information (e.g., local lab reports, liver/spleen scan results, GFR results) to the new Clinical Center's Primary Endpoint Person.

### **6.4.3 Consenting the Patient at the New Clinical Center**

The new Clinical Center must consent the patient as if s/he were a new patient, never previously enrolled in the study. The Study Coordinator at the original Clinical Center should inform the patient's family that they must re-consent at the new Clinical Center. All the procedures required for consent must be followed, including explanation of the study and a meeting with a Patient Family Advocate should be arranged prior to signing the consent. The patient must be informed that being at the new Clinical Center may come with new regulations, possibly including different IRB regulations and different state regulations.

The patient becomes the responsibility of the new Clinical Center after the informed consent for the new Clinical Center is signed.

#### **6.4.4 First Visit at the New Clinical Center**

The original Clinical Center will work with the family to get a firm date of when the family will be in the new area. The Study Coordinator at the original Clinical Center will assist the family in scheduling an appointment with the new Clinical Center that will fall in their present visit window. The patient should be informed that they should continue to contact the original Clinical Center concerning all medical issues until the first study visit at the new Clinical Center has been completed. From that time onward, the patient is to be informed that all medical issues should be discussed with the new Clinical Center.

The original Clinical Center's Study Coordinator will follow up with the potential transfer patient until such time as the patient actually completes a visit at the new Clinical Center. This is necessary to prevent the patient from dropping out of active participation in the study during this period. Letters or telephone calls from the original Clinical Center may encourage the patient to continue his/her involvement in the study. If a patient decides not to participate at the new Clinical Center s/he remains the responsibility of the original Clinical Center. It becomes the responsibility of the original Clinical Center to withdraw the patient from the study.

Upon completion of the first visit at the new Clinical Center, the new Clinical Center's Study Coordinator will confirm the transfer by completing Part II of Form C: Notification of Patient Transfer and faxing a copy to the Medical Coordinating Center. This will confirm that the patient has come in for their first visit at the new Clinical Center and was consented. Once the MCC has been notified, the new Clinical Center will be given access to the patient's forms on the database. After the first visit at the new Clinical Center is complete, the original Clinical Center will not follow this patient any further. All data entry will be the responsibility of the new Clinical Center.

#### **6.4.5 Transfer of Study Treatment**

Transfer of study treatment will be coordinated between the original Clinical Center's Pharmacist and the new Clinical Center's Pharmacist. All study treatment currently available at the original Clinical Center will be shipped to new Clinical Center. The original Clinical Center's

pharmacy will send any remaining study treatments along with invoices, dispensing records and a treatment accountability form containing only the transferring patient's information to the Pharmacist at the new Clinical Center. The new Clinical Center's Pharmacist will confirm receipt of the shipment from the original Clinical Center's Pharmacist via email; the MCC shall be copied on this email. Study treatment should be sent in close proximity to the official date of the transfer in case a need arises for the patient to get more study treatment from the original Clinical Center (e.g., loss or spillage). Treatment already dispensed to the patient will be moved with the patient's family. The next dispensing of study treatment will be reconstituted by the new Clinical Center before the patient's scheduled visit.

The Pharmacy Distribution Center which prepares and ships bottles containing hydroxyurea and placebo will be notified by the MCC that the treatment kit for the transferred patient has been moved from one Clinical Center to another. All subsequent shipments of that patient's treatment kit will be sent to the new Clinical Center.

The treatment allocation will remain the same and the transferred child will not affect the randomization process of future patients entering the study at the new Clinical Center. The treatment kit number for the treatment allocation will also remain the same. The patient's treatment will remain blinded for staff at both the new and original Clinical Centers.

#### **6.4.6 Additional Issues**

The original Clinical Center's Study Coordinator will confirm that the new Clinical Center is aware of any stop orders or adverse events concerning the child between the last visit with the initial Clinical Center and before the patient has their first visit with the new Clinical Center. The coordinator at the MCC will expect acknowledgment from the new Clinical Center that they are aware of any changes in the patient's study treatment or medical condition. In the instance that a stop order has occurred in the previous 2- or 4-week period, a new bottle of study treatment will be dispensed by the new Clinical Center when the patient comes in for their (first) visit to check for toxicities.

Information that the Medical Coordinating Center previously transmitted electronically to the original Clinical Center (e.g., dose recommendations, stop orders) will be sent to the new Clinical Center after receipt of a completed Notification of Patient Transfer.

Form editing will become the responsibility of the new Clinical Center beginning on the official transfer date. If changes required are on forms previously completed by the original Clinical Center, it is the responsibility of the new Clinical Center to make corrections after the official transfer date. All Protocol deviations and errors that occurred before the time of transfer will be attributed to the original Clinical Center.

## **6.5 LOCAL CBC GUIDELINES**

### **6.5.1 Routine Study Visits**

At every routine study visit for each child, Clinical Center staff will draw up to 0.5 ml of blood for a local CBC determination. Each center will designate the person (a hematologist, nurse practitioner or physician's assistant, see Protocol Chapter 10.2.1) who will monitor each child's blood work for possible toxicities and/or alerts. Toxicities will result in treatment interruptions whereas alerts are intended as possible indicators of adverse events such as splenic sequestration, aplastic crisis, renal insufficiency, etc., requiring further clinical evaluations or interventions by the Clinical Center staff.

The Coordinator at each site will notify the Primary Endpoint Person (PEP) as soon as possible when blood specimens are collected. The Coordinator will send the specimens to the local laboratory. The PEP will retrieve and review the laboratory values for toxicity and alert monitoring levels (see Exhibit 6-3).

The PEP will data-enter the local CBC data into the BABY HUG database system via the Internet Data Entry system. The same label number must be used for the local CBC specimen as the corresponding six-month interval central hematology specimen. A label number must also be used if just a local CBC is drawn. The data must be entered within 24 hours of the blood draw or

no later than 9:00 a.m. EST the following morning. The PEP should be available to answer edit questions that may come from the MCC.

#### **6.5.1.1 Toxicities**

If the review of the local CBC laboratory values shows a toxicity, the PEP will notify the Clinical Center staff of the need for a stop order. If there is not a toxicity, the PEP will open a previously delivered notice from the MCC that will instruct whether the PEP is to report a sham toxicity for the visit. Once reported, all other aspects of the reporting mechanisms will be done in the same manner as if the toxicity is real (e.g., a meeting with Clinical Center staff, etc. to perpetuate the notion that the report is in fact a real toxicity).

#### **6.5.1.2 Alerts**

The PEP will also review the local CBC results to determine if an alert is present in the data. If an alert level is detected, the Clinical Centers will use the following guidelines for responding to notification of an alert.

Every time a value exceeds the alert level:

1. The PEP will handle the alert in a straightforward manner when possible, or, more likely, contact a Hematologist/Sickle Cell Specialist who is not directly connected with the BABY HUG Trial.
2. When indicated, the PEP and the Hematologist will develop a plan for a clinical response to the alert value. (For example: If the patient were severely neutropenic and febrile, the patient would be hospitalized for antibiotic treatment; if the patient had > 20% decrease in hemoglobin level, the patient would be hospitalized and/or transfused; if the patient met criteria for a splenic sequestration, the patient would be hospitalized and or transfused; etc.).
3. In the event that no non-BABY HUG Hematologist was available, the PEP would need to contact the BABY HUG PI and discuss a course of action. In doing so, the PEP would provide the PI only with “need to know” laboratory information. In most cases,

this will not create an unblinding problem because, for example: severe neutropenia may more likely be related to an acute viral infection rather than HU toxicity; worse anemia might be caused by an aplastic crisis or splenic sequestration rather than HU; splenic sequestration might or might not be related to HU, etc. In most situations, CBC values would not readily distinguish between treatment with hydroxyurea or placebo, although it is important that the MCV should not be revealed to the PI or BABY HUG Study Coordinators.

4. In the ensuing management of the child, the bulk of the decision-making should be carried out by the non-BABY HUG Hematologist and the PEP.
5. The alert values for increased hematologic blood counts would not necessarily warrant any immediate reaction by a clinician.

### **6.5.2 Unscheduled Study Visits**

If a child has an unscheduled visit (e.g., an Emergency Room visit) with local CBC determinations, and the blood results show a toxicity, the PEP will notify the Clinical Center staff of the need for a stop order. The PEP will data-enter the blood results into the BABY HUG database system via the Internet data entry system. The data must be entered within 24 hours of notification of blood draw results. The child must then return for two week visits until the toxicity is resolved. If local blood results subsequent to the unscheduled visit but prior to the 2-week visit no longer show a toxicity, study treatment can be resumed and a Form 65 (Restart Treatment Order) is entered. If the unscheduled visit blood results do not show a toxicity, the local blood results are not to be entered into the BABY HUG database system.

## **6.6 ADVERSE EVENTS MONITORING**

### **6.6.1 Definitions**

The MCC, NHLBI, and the DSMB will continuously monitor the safety of study treatments. **An adverse event (AE) is an unfavorable/unintended sign, symptom or disease that was not present at baseline, or if present has worsened.** Every AE will be recorded during treatment



(randomization to completion). *Each AE must be recorded at the time of the event* (i.e., as soon as the Clinical Center staff learn of the occurrence of the event, records of the event must be initiated).

**A serious adverse event is an untoward medical event that is fatal, life threatening (in the view of the investigator), causes or prolongs a hospitalization, or poses a risk of permanent disability.** However, serious adverse events which are reportable to the FDA lack specificity to the disease process of sickle-cell anemia or the age of the patients in this study. In particular, children are frequently hospitalized for events that are part of the disease process. This could produce biased reporting. In addition, the definition of “life threatening events” is not specific to the sickle cell disease process and there may be differences in interpretation about whether some of these specific events are indeed “life threatening”. To remedy that situation, serious adverse events that are sickle cell related have been added to the FDA list of serious adverse events, and some FDA definitions have been modified or deleted. This modified list (see Section 6.5.2) are Severe Adverse Events (SAE) in BABY HUG. The Principal Investigator must make an initial report (even if incomplete) of any SAE or unexpected adverse event to the MCC and the institutional IRB *within 24 hours* of learning of the SAE. SAEs that occur after consent has been obtained must also be recorded and reported.

### **6.6.2 Monitoring and Reporting Adverse Events**

Monitoring for adverse events and hospitalizations will be done at each study visit using Form 31 (Part II, Item 6). All details of events (AE and SAE) and hospitalizations will be reported and recorded on Form 50.

The following events are to be considered Severe Adverse Events (SAE) in the BABY HUG study. Any serious adverse events (as defined by the FDA) which are not included in this list will be summarized and reported annually and semi-annually.

- Death
- Stroke/TIA

- Splenic sequestration
- Acute Chest Syndrome
- Life-threatening events
- Prolonged hospitalization (greater than 7 days)
- ICU admissions

Among events known to occur among children with sickle cell anemia, an AE includes (but is not limited to):

- Dactylitis
- Vasocclusive pain crisis
- Priapism
- Biliary obstruction
- Hepatopathy
- Hepatic sequestration
- Pancreatitis
- Fever > 101.5 F (38.5.C)
- Acute renal failure
- Chronic renal failure
- Septicemia
- Severe neutropenia
- Aplastic crises
- Acute osteomyelitis
- Meningitis
- Splenomegaly

More broadly, an adverse experience is any untoward medical occurrence experienced by a patient enrolled in BABY HUG whether or not deemed to be associated with the study medication.

- Any treatment emergent signs and symptoms (events that are marked by a change from the patient's baseline/entry status e.g., an increase in severity or frequency of pre-existing abnormality or disorder)
- Extensions or exacerbations of symptomatology, subjective events, new clinically significant abnormalities in clinical laboratory, physiological testing or physical examination
- All reactions from study drug, an overdose, abuse of drug, withdrawal phenomena, sensitivity or toxicity to study drug
- Apparently unrelated illnesses
- Injury or accidents (If a medical condition is known to have caused the injury or accident, the medical condition and the accident should be reported as two separate medical events e.g., for a fall secondary to dizziness, both "dizziness" and "fall" should be recorded separately).

The Primary Endpoint Person (in conjunction with a non-BABY HUG hematologist, if necessary) will review hospital charts, medical records and office visit records to ascertain the AE/SAE diagnosis, duration, degree of severity (mild to fatal), possible attribution to study treatment (unrelated to definite) and expectedness (Form 50, Part IV). The duration of an event includes both the beginning and ending day of the event. An unexpected adverse experience is an adverse experience not previously identified in nature, severity or frequency in the risk information described in the Protocol, Informed Consent or listed in the current product labeling of the study medication. Each BABY HUG Severe Adverse Event or Unexpected Adverse Event must be reported on a U.S. FDA Med Watch Form 3500A (Exhibit 6-4). Detailed information on completion of Med Watch forms and an electronically completable form are available at:

[www.fda.gov/medwatch/SAFETY/FDA3500A\\_fillable.pdf](http://www.fda.gov/medwatch/SAFETY/FDA3500A_fillable.pdf)

Submit the Med Watch form by facsimile transmission (FAX) to the BABY HUG MCC (443-524-2320).

In addition to this reporting mechanism, a centralized over-ride system will be carried out by individuals with knowledge about the treatment assignments. These individuals will review adverse events that are not thought to be serious in the eyes of the blinded investigators and make decisions about whether an adverse event is “serious” and reportable to the FDA. The two central review individuals will be the NHLBI Project Officer and MCC Medical Consultant. Either of these individuals will have the ability to elevate an adverse event being reported to the MCC to the “severe” category which will precipitate the collection of the required information for the Med Watch Form 3500A and a subsequent report to the FDA.

### **6.6.3 Event Start and Stop Dates**

General guidelines for event start and stop dates recorded on a Form 50 are the following. Day 2 of an event begins the next calendar day after presentation. The event stop date is the parent/guardian’s perception of when there is no longer a problem, unless the stop date has been determined previously.

Specific SAE/AE start and stop dates are the following. Note that a “baseline” laboratory value refers to the last value measured prior to the day treatment begins. (Baseline or screening testing may occur on more than one visit see section 6.2.2).

#### **6.6.3.1 Serious Adverse Events**

Death: **Start** and **Stop** the same.

Stroke: **Definition** - Symptoms/signs persist > 24 hours. Clinical findings best explained by cerebrovascular disease. Imaging evidence of new infarct or cerebral hemorrhage by MRI, CT, MRA, arteriogram, or PET scan.

**Start** - Time of the first neurologic abnormalities on physical exam.

**Stop** - Time when symptom progression has ceased or one week has transpired from the start.

TIA: **Definition** - New neurologic condition lasting < 24 hours and best explained by cerebrovascular disease.

**Start** - Time of the first symptoms

**Stop** - 24 hours later

Splenic Sequestration: **Definition** - Spleen has increased  $\geq 2$  cm from the last visit AND Hb level is  $\geq 2$  gm/dl below the 3 month rolling average.

**Start** - Time when definition is first met

**Stop** - Time when the patient is clinically well and the hemoglobin level is no longer  $\geq 2$  gm/dl below the 3-month rolling average and has been stable for 2 weeks.

Acute Chest Syndrome: **Definition** -  $\geq 3$  of the following conditions are present: chest pain, fever ( $\geq 38.5^\circ\text{C}$ ), tachypnea, wheezing, or cough. There is a new infiltrate on CXR involving at least one complete lung segment consistent with alveolar consolidation, not atelectasis.

**Start** - Time when definition is first met

**Stop** - Time when patient is stable, afebrile for  $\geq 24$  hours, and does not require oxygen or transfusion.

### 6.6.3.2. Adverse Events

Dactylitis: **Definition** - pain and tenderness with or without swelling in the hands and/or feet.

**Start** - Time when definition is first met.

**Stop** - Time when pain is resolved or manageable with non-opioid analgesia.

Pain crisis: **Definition** - Pain lasts  $\geq 2$  hours and analgesic is required.

**Start** - Time of onset of pain

**Stop** - Time when pain resolved, function returned and pain medication discontinued.

Priapism: **Definition** - Painful erection of the penis for > 2 hours.

**Start** - Time of onset of painful erection

**Stop** - Time when detumescence has lasted  $\geq$  24 hours.

Biliary obstruction: **Definition** - two-fold increase in total bilirubin over patient's baseline value to a level exceeding the upper limit of normal.

**Start** - Time when definition is first met.

**Stop** - Time when bilirubin has returned to the patient's baseline value.

Hepatic sequestration: **Definition** - hyperbilirubinemia and RUQ pain not due to cholelithiasis with decrease in Hb level  $\geq$  2 gm/dL below the 3-month rolling average.

**Start** - Time when definition met.

**Stop** - Time when pain resolved, bilirubin level returned to patient's baseline value and Hb level within 2 gm of the 3-month rolling average is stable for 2 weeks

Fever **Definition** Temperature  $>$  101.5 F (38.5°C)

**Start** - Time when defining temperature documented in medical setting.

**Stop** - Time when temperature  $<$  38°C for  $>$  24 hours.

Renal failure: **Definition** -  $\geq$  2-fold increase in serum creatinine (compared to the patient's baseline creatinine) to a level  $\geq$  1.0 mg/dL.

**Start** - Time when defining lab results drawn.

**Stop** - Time when creatinine level  $<$  2 x patient's baseline value and  $<$  1.0 mg/dL.

Septicemia: **Definition** - febrile illness with positive blood culture.

**Start** - Time when positive blood culture drawn.

**Stop** - Time when antibiotic course has been completed and negative blood culture drawn.

Severe neutropenia: **Definition** - neutrophil count  $<$  0.5 K/mm<sup>3</sup>

**Start** - Time when defining lab result is drawn.

**Stop** - Time when neutrophil count  $\geq$  1.25 K/mm<sup>3</sup>

Splenomegaly: **Definition** -  $\geq 2$  cm increase in spleen size from last visit.

**Start** - Time when definition met.

**Stop** - Time when spleen is  $< 2$  cm greater than the size at last visit.

Aplastic crises: **Definition** - reticulocyte count  $< 1.5\%$  and  $> 30\%$  decrease in hemoglobin level below the 3-month rolling average.

**Start** - Time when definition met.

**Stop** - Time when reticulocyte count  $> 1.5\%$  and hemoglobin level no longer  $> 30\%$  below the 3-month rolling average and stable for 2 weeks.

Acute osteomyelitis: **Definition** - bacterial infection of the bone (positive blood culture and abnormal MRI, bone scan or bone biopsy)

**Start** - Time when positive blood culture drawn.

**Stop** - Time when antibiotic course has been completed and negative blood culture is drawn.

#### Meningitis

**Start** - Time when positive CSF culture drawn.

**Stop** - Time when antibiotic course has been completed and negative CSF culture is drawn.

Abnormal TCD: **Definition** - TAMM velocity  $\geq 200$  cm/sec in MCA or distal ICA

**Start** - Time when abnormal TCD first performed.

**Stop** - Time when a normal/conditional TCD is performed or patient is begun on chronic transfusion.

UTI: **Definition** - urine culture positive for  $> 100,000$  colonies of a single bacterial type.

**Start** - Time when positive urine culture obtained.

**Stop** - Time when antibiotic course has been completed and negative urine culture is obtained.

#### **6.6.4 Reporting Treatment, Management and Outcomes of AE/SAE**

Treatments will be recorded on Form 50, Part V. Reportable treatments include:

- Transfusion: simple vs exchange, volume and PRBC vs whole blood
- Placement on chronic transfusion program: (complete End of Randomized Treatment, Form 36 and Stop Treatment Form 64, also)
- Bone marrow transplant (complete Forms 36 and 64, also)
- Splenectomy
- Cholecystectomy
- Parental antibiotics
- Butyrate
- Dialysis, acute limited
- Dialysis, chronic (complete Forms 36 and 64, also)
- Renal transplant or candidate (Forms 36 and 64, also)

The location/type of management (out patient, hospitalization, or prolonged hospitalization) is recorded on Form 50, Part VI. The hospital's name and address is recorded in Part VII. Possible outcomes of the event (disability, death) are recorded on Form 50, Part VIII.

#### **6.6.5 Additional Severe Adverse Event and Unexpected Adverse Event Reporting**

##### **6.6.5.1 Notifications**

- Within 24 hours of learning of the SAE or an unexpected adverse event, the Principal Investigator (PI) should notify the Medical Coordinating Center (MCC) and the Chairperson of the local IRB.
- Within 5 business days, the PI should provide a written report (even if preliminary) to the MCC and IRB.
- Within 24 hours of receipt of this information, the MCC will review the SAE and notify the NHLBI Project Officer. The MCC will be responsible for communication of reports to the FDA.



### 6.6.5.2 Documentation

SAEs and unexpected adverse events will be documented on Form 50 (Parts II-VIII). Degree of severity will be assigned based on clinical information recorded. The following additional information will be recorded in Part III.

#### Acute Chest Syndrome

- New infiltrate on chest x-ray: single lobe vs multilobe
- O<sub>2</sub>% on room air at presentation
- % oxygen administered
- Mechanical ventilation

#### Splenic Sequestration

- Spleen size
- Hemoglobin nadir
- Platelet count at hemoglobin nadir

#### Stroke/TIA

- Symptoms
- Results of imaging studies as available
  - MRI of brain
  - CT of brain
  - PET of brain
  - MRA of brain
  - TCD
  - Arteriogram
- Neurological Examination and Questionnaire (Form 43)

## Death

In the event of the death of a study patient, efforts should be made to obtain post-mortem information. Discharge summaries and narrative events of the fatal event should be recorded on study Form 50 and sent to the MCC.

## Exhibit 6-1

### Optimizing Guidelines for Completing the 24M Visit

When scheduling the end-of-study assessments, please keep in mind the following guidelines. The purpose of some of these guidelines is to ascertain that comparative studies are done at nearly the same time.

1) Only the Liver/Spleen Scan and the DTPA GFR are required to be performed while the patient is on study treatment. The TCD Neuropsych, Neuro evaluation, immunology, and central blood can be collected after the DTPA test (the projected end of study treatment).

**Rationale: The Liver/Spleen test and the DTPA GFR must be performed while the child is on study treatment – they are the primary endpoints of this study. The other endpoints are secondary. A precedent has been set that HU effects may be present as long as two weeks after study treatment is discontinued.**

2) Liver/spleen scan:

a) Perform at least 72 hours prior to the DTPA/GFR procedure. If possible, collect the pitted cell count, biochemistry and urine specimens on the same day the liver/spleen scan is performed. If this cannot be done, obtain these specimens as close to the date of performance of the liver/spleen scan as possible.

b) If done on the same date, draw the blood specimens before the radionuclide is injected.

**Rationale: We want the last study to be performed on treatment to be the DTPA. In order to do this, you must allow at least three days for the isotope from the L/S scan to decay. Pitted cells will be coupled with the L/S scan in BABY HUG analyses. The sonogram and Urine Osmolality (UO) require the patient to be NPO and the chemistry (which includes the serum osmolality) must be done on the same day as the UO.**

3) DTPA/GFR procedure:

a) The next to the last dose of study treatment must be administered at least 12 hours before the DTPA/GFR procedure is performed. Contact the parent/guardian the day before the DTPA/GFR procedure and instruct them to give the dose to the child more than 12 hours before the scheduled time of the DTPA/GFR procedure.

b) Instruct the pharmacist to mix a new bottle of study treatment on the day of the DTPA/GFR procedure. This is to optimize data collection for the 24-month PK study (blood for the PK study will be the same blood collected for the DTPA/GFR study).

c) In accordance with the December 2005 Protocol, administer the child's last daily dose 30 minutes after injecting the DTPA, and draw the DTPA/GFR specimens at the standard times (1, 2 and 4 hrs).

d) Collect the bottle of study treatment the patient has been using for the previous period and do not dispense the newly reconstituted bottle to the patient.

**Rationale: The final pharmacokinetic study is a very important test for the NICHD. The concentration of the HU ingested by the child should be as accurate as possible. By using a new bottle, there is more control over the exact concentration of the study treatment at the time of the test (i.e., the previous bottle may not have been shaken well during previous treatment administrations which could produce slight changes in the treatment concentration).**

4) Urinalysis should be conducted the same day the urine concentrating ability specimen is collected.

**Rationale: Specific gravity from the UA is being correlated with the Urine Concentrating Ability.**



**EXHIBIT 6 - 3**

**Toxicity and Alert Levels**

	<b>Low Alert</b>	<b>Low Toxicity</b>	<b>High Alert</b>	<b>High Toxicity</b>
<b>WBC</b>			50	
<b>Hb</b>	6.0 gm/dL <b>or</b> 20% drop from 3 month rolling avg	6.0 gm/dL <b>or</b> 20% drop from 3 month rolling avg	13.3 gm/dl for 2 follow-up visits	
<b>Platelets</b>	80 K/mm <sup>3</sup>	80 K/mm <sup>3</sup>	1M/mm <sup>3</sup>	
<b>ANC</b>	1.25 K/mm <sup>3</sup>	1.25 K/mm <sup>3</sup>	30K/mm <sup>3</sup>	
<b>Reticulocytes</b>	80 K/mm <sup>3</sup> <b>and</b> Hb < 7.0 gm/dL	80 K/mm <sup>3</sup> <b>and</b> Hb < 7.0 gm/dL		
<b>Creatinine</b>			double from baseline <b>and</b> greater than 1.0 mg/dL	double from baseline <b>and</b> greater than 1.0 mg/dL
<b>Bilirubin</b>			10 mg/dL	10 mg/dL
<b>ALT</b>			150 IU/L	150 IU/L

NOTE: Low alerts and toxicities must be less than the values listed in the table.  
High alerts and toxicities must be greater than the values listed in the table.

U.S. Department of Health and Human Services

# MEDWATCH

The FDA Safety Information and Adverse Event Reporting Program

For use by user-facilities, importers, distributors and manufacturers for MANDATORY reporting

Page \_\_\_ of \_\_\_

Mfr Report #
UF/Importer Report #

FDA Use On

A. PATIENT INFORMATION			
1. Patient Identifier  In confidence	2. Age at Time of Event: or _____ Date of Birth:	3. Sex <input type="checkbox"/> Female <input type="checkbox"/> Male	4. Weight _____ lbs or _____ kgs
B. ADVERSE EVENT OR PRODUCT PROBLEM			
1. <input type="checkbox"/> Adverse Event and/or <input type="checkbox"/> Product Problem (e.g., defects/malfunctions)			
2. Outcomes Attributed to Adverse Event (Check all that apply)			
<input type="checkbox"/> Death: _____ (mo/day/yr)		<input type="checkbox"/> Disability	
<input type="checkbox"/> Life-threatening		<input type="checkbox"/> Congenital Anomaly	
<input type="checkbox"/> Hospitalization - initial or prolonged		<input type="checkbox"/> Required Intervention to Prevent Permanent Impairment/Damage	
<input type="checkbox"/> Other: _____			
3. Date of Event (mo/day/year)		4. Date of This Report (mo/day/year)	
5. Describe Event or Problem			
6. Relevant Tests/Laboratory Data, including Dates			
7. Other Relevant History, including Preexisting Medical Conditions (e.g., allergies, race, pregnancy, smoking and alcohol use, hepatic/renal dysfunction, etc.)			

C. SUSPECT MEDICATION(S)			
1. Name (Give labeled strength & mfr/labeler, if known)			
#1 _____			
#2 _____			
2. Dose, Frequency & Route Used		3. Therapy Dates (If unknown, give duration from/to (or best estimate)	
#1 _____		#1 _____	
#2 _____		#2 _____	
4. Diagnosis for Use (Indication)		5. Event Abated After Use Stopped or Dose Reduced?	
#1 _____		#1 <input type="checkbox"/> Yes <input type="checkbox"/> No <input type="checkbox"/> Does Apply	
#2 _____		#2 <input type="checkbox"/> Yes <input type="checkbox"/> No <input type="checkbox"/> Does Apply	
6. Lot # (if known)	7. Exp. Date (if known)	8. Event Reappeared After Reintroduction?	
#1 _____	#1 _____	#1 <input type="checkbox"/> Yes <input type="checkbox"/> No <input type="checkbox"/> Does Apply	
#2 _____	#2 _____	#2 <input type="checkbox"/> Yes <input type="checkbox"/> No <input type="checkbox"/> Does Apply	
9. NDC# (For product problems only)			
- -			
10. Concomitant Medical Products and Therapy Dates (Exclude treatment of event)			

D. SUSPECT MEDICAL DEVICE			
1. Brand Name			
2. Type of Device			
3. Manufacturer Name, City and State			
4. Model #	Lot #	5. Operator of Device	
Catalog #	Expiration Date (mo/day/yr)	<input type="checkbox"/> Health Professional	
Serial #	Other #	<input type="checkbox"/> Lay User/Patient	
6. If Implanted, Give Date (mo/day/yr)		<input type="checkbox"/> Other: _____	
7. If Explanted, Give Date (mo/day/yr)			
8. Is this a Single-use Device that was Reprocessed and Reused on a Patient?			
<input type="checkbox"/> Yes <input type="checkbox"/> No			
9. If Yes to Item No. 8, Enter Name and Address of Reprocessor			
10. Device Available for Evaluation? (Do not send to FDA)			
<input type="checkbox"/> Yes <input type="checkbox"/> No <input type="checkbox"/> Returned to Manufacturer on: _____ (mo/day/yr)			
11. Concomitant Medical Products and Therapy Dates (Exclude treatment of event)			

E. INITIAL REPORTER			
1. Name and Address		Phone #	
2. Health Professional?	3. Occupation	4. Initial Reporter Also Sent Report to FDA	
<input type="checkbox"/> Yes <input type="checkbox"/> No		<input type="checkbox"/> Yes <input type="checkbox"/> No <input type="checkbox"/> Un	

PLEASE TYPE OR USE BLACK INK



Submission of a report does not constitute an admission that medical personnel, user facility, importer, distributor, manufacturer or product caused or contributed to the event.

FORM FDA 3500A (9/03)

**EXHIBIT 6 - 4 (Continued)**

**Medication and Device Experience Report**

(Continued)

Submission of a report does not constitute an admission that medical personnel, user facility, importer, distributor, manufacturer or product caused or contributed to the event.

U.S. DEPARTMENT OF HEALTH AND HUMAN SERVICES  
Public Health Service • Food and Drug Administration

FDA USE ONLY

Refer to guidelines for specific instructions.

Page \_\_\_\_ of \_\_\_\_

F. FOR USE BY USER FACILITY/IMPORTER (Devices Only)			
1. Check One <input type="checkbox"/> User Facility <input type="checkbox"/> Importer		2. UF/Importer Report Number	
3. User Facility or Importer Name/Address			
4. Contact Person		5. Phone Number	
6. Date User Facility or Importer Became Aware of Event (mo/day/yr)		7. Type of Report <input type="checkbox"/> Initial <input type="checkbox"/> Follow-up # _____	8. Date of This Report (mo/day/yr)
9. Approximate Age of Device	10. Event Problem Codes (Refer to coding manual) Patient Code: [ ] - [ ] - [ ] Device Code: [ ] - [ ] - [ ]		
11. Report Sent to FDA? <input type="checkbox"/> Yes (mo/day/yr) <input type="checkbox"/> No	12. Location Where Event Occurred <input type="checkbox"/> Hospital <input type="checkbox"/> Outpatient Diagnostic Facility <input type="checkbox"/> Home <input type="checkbox"/> Ambulatory Surgical Facility <input type="checkbox"/> Nursing Home <input type="checkbox"/> Outpatient Treatment Facility <input type="checkbox"/> Other: _____ (Specify)		
13. Report Sent to Manufacturer? <input type="checkbox"/> Yes (mo/day/yr) <input type="checkbox"/> No	14. Manufacturer Name/Address		

G. ALL MANUFACTURERS	
1. Contact Office - Name/Address (and Manufacturing Site for Devices)	2. Phone Number
4. Date Received by Manufacturer (mo/day/yr)	3. Report Source (Check all that apply) <input type="checkbox"/> Foreign <input type="checkbox"/> Study <input type="checkbox"/> Literature <input type="checkbox"/> Consumer <input type="checkbox"/> Health Professional <input type="checkbox"/> User Facility <input type="checkbox"/> Company Representative <input type="checkbox"/> Distributor <input type="checkbox"/> Other: _____
6. If IND, Give Protocol #	5. (A)NDA # _____ IND # _____ PLA # _____ Pre-1938 <input type="checkbox"/> Yes OTC Product <input type="checkbox"/> Yes
7. Type of Report (Check all that apply) <input type="checkbox"/> 5-day <input type="checkbox"/> 15-day <input type="checkbox"/> 10-day <input type="checkbox"/> Periodic <input type="checkbox"/> Initial <input type="checkbox"/> Follow-up # _____	8. Adverse Event Term(s)
9. Manufacturer Report Number	

H. DEVICE MANUFACTURERS ONLY	
1. Type of Reportable Event <input type="checkbox"/> Death <input type="checkbox"/> Serious Injury <input type="checkbox"/> Malfunction <input type="checkbox"/> Other: _____	2. If Follow-up, What Type? <input type="checkbox"/> Correction <input type="checkbox"/> Additional Information <input type="checkbox"/> Response to FDA Request <input type="checkbox"/> Device Evaluation
3. Device Evaluated by Manufacturer? <input type="checkbox"/> Not Returned to Manufacturer <input type="checkbox"/> Yes <input type="checkbox"/> Evaluation Summary Attached <input type="checkbox"/> No (Attach page to explain why not) or provide code: _____	4. Device Manufacture Date (mo/yr)
5. Labeled for Single Use? <input type="checkbox"/> Yes <input type="checkbox"/> No	
6. Evaluation Codes (Refer to coding manual) Method: [ ] - [ ] - [ ] - [ ] Results: [ ] - [ ] - [ ] - [ ] Conclusions: [ ] - [ ] - [ ] - [ ]	
7. If Remedial Action Initiated, Check Type <input type="checkbox"/> Recall <input type="checkbox"/> Notification <input type="checkbox"/> Repair <input type="checkbox"/> Inspection <input type="checkbox"/> Replace <input type="checkbox"/> Patient Monitoring <input type="checkbox"/> Relabeling <input type="checkbox"/> Modification/Adjustment <input type="checkbox"/> Other: _____	8. Usage of Device <input type="checkbox"/> Initial Use of Device <input type="checkbox"/> Reuse <input type="checkbox"/> Unknown
9. If action reported to FDA under 21 USC 360(f), list correction/removal reporting number: _____	
10. <input type="checkbox"/> Additional Manufacturer Narrative	and / or    11. <input type="checkbox"/> Corrected Data

The public reporting burden for this collection of information has been estimated to average one hour per response, including the time for reviewing instructions, searching existing data sources, gathering and maintaining the data needed, and completing and reviewing the collection of information. Send comments regarding this burden estimate or any other aspect of this collection of information, including suggestions for reducing this burden to:

FORM FDA 3500A (9/03) (Back)

Department of Health and Human Services  
Food and Drug Administration  
MedWatch; HFD-410  
5600 Fishers Lane  
Rockville, MD 20857

Please DO NOT RETURN this form to this address.

**OMB Statement:**  
"An agency may not conduct or sponsor, and a person is not required to respond to, a collection of information unless it displays a currently valid OMB control number."

**PEDIATRIC HYDROXYUREA PHASE III CLINICAL TRIAL (BABY HUG)  
MANUAL OF OPERATIONS**

**CHAPTER 7**

**COLLECTION AND SHIPMENT OF SPECIMENS FOR CENTRAL LABORATORIES**

**7.1 OVERVIEW**

The purpose of this chapter is to provide guidelines for the collection, preparation and shipment of blood and urine specimens to the BABY HUG core laboratories. Sections 7.4 - 7.10 in this chapter delineate those guidelines. Table 7-1 summarizes the required Core Laboratory specimens. It should be noted that all specimens that will be shipped to the Core Laboratories must be shipped Monday through Thursday. Core Laboratories cannot process specimens over the weekend. At times, it may not be possible to collect all required specimens at a study visit; Exhibit 7-1 shows the blood specimen collection priorities.

**TABLE 7-1**

**Summary of Core Laboratory Specimens**

<b>Specimen</b>	<b>Whole blood amount</b>	<b>Collection tube type</b>	<b>Frequency</b>
Hematology	0.5 ml	EDTA lavender top	Screening, trt. initiation, every 6 months, exit
Biochemistry	1.0 ml (2 ml at screening only)	Red top	Screening, treatment initiation, every 6 months, exit
Urine	>0.1 ml urine	cryovial	2x (screening and exit)
Cytogenetics	4.0 ml	NA Heparin green top	2x (screening & exit)
DNA	3.0 ml	EDTA lavender top	2x (screening & exit)
Pitted Cells	50 µl	EDTA lavender top*	5x (screening, 6, 12, 18 months and exit)
Immunology: Pneumo antibody/serum opsonic assay	3.0 ml	Red top*	4x (screening, 23 & 26 months old, exit)
Immunology: MMR antibody	1.2 ml	Red top	3x (after MMR, 23 months old, exit)
Immunology: CD4/CD8 T-cells	0.5 ml	EDTA lavender top	3x (screening, 23 months old, exit)
Biomarkers**	0.5 ml 0.5 ml 0.5 ml	EDTA lavender top* EDTA lavender top* ACD microfuge*	4x (screening, 8 weeks, 24 weeks & exit)

\*Additional preparation needed; see appropriate section in Chapter 7.

\*\*For Clinical Centers participating in the Biomarker Ancillary Study.



## 7.2 LABELS

The BABY HUG Medical Coordinating Center (MCC) provides each Clinical Center with pre-printed labels for all specimens: blood, urine and images. The BABY HUG labels are randomized 5-digit numbers to ensure the processing laboratories remain “blind” to patient identification.

The Clinical Center will receive sets of label sheets grouped by Patient ID Number. When a child begins the screening process and is assigned a Patient ID Number (on Form 04: Eligibility Screening I), the set of label sheets with that Patient ID Number shall be used exclusively for that child for all of his/her specimens throughout the entire study. These child-specific label sheets enable the MCC to link a particular specimen to the child when the label number is entered in the database. Two-hundred label numbers are assigned to each child; a single label *number* is to be used per specimen.

Two sizes of labels (small and large) are provided. The small labels ( $\frac{1}{2}$ " x 1") are to be used for tubes and vials (see Exhibit 7-2 for a sample label sheet). The labels in the first column have the Patient ID Number (e.g., 9998) and a label sequence number that is for MCC use. These labels will not be used. Each row on these label sheets consists of six duplicate labels with the same label number and label code. In general, a duplicate label (with the same label number) should be affixed to the specimen, the study form which requested the specimen, and the transmittal form for shipping the specimen. Cross off all unused labels in a row.

The large labels (1" x 2  $\frac{5}{8}$ ") are to be used for all films (liver/spleen scans and abdominal sonograms). See Exhibit 7-3 for a sample label sheet. Each of these label sheets has two unique label numbers, with 14 duplicate labels for each of the label numbers. The Patient ID Number and label sequence number are printed on the label in the first row of the label numbers and will not be used. In general, a duplicate label (with the same label number) should be affixed to all film sheets (e.g., if a child’s liver/spleen scan results in 5 sheets of film, a label must be affixed to each of the five film sheets), the study form which requested the image, and the transmittal form for shipping the films. Cross off all unused labels for a particular label number.

## 7.3 SHIPPING TRANSMITTAL FORMS

Study forms, transmittal forms and data files are used to track processing, shipment and receipt of biological specimens used in BABY HUG from Clinical Centers to Core Laboratories and

the Central Repository. All blood specimens collected and shipped must be handled according to universal precautions. If a specimen is known to be infectious, it must be shipped following the necessary additional procedures.

All shipments to Core Laboratories must be accompanied by a transmittal form. Each specimen type has a specific transmittal form (e.g., Form 101 is for hematology specimens, Form 103 is for Pitted Cell Count specimens). Transmittal forms are accessed via the Forms Selection Process (see Section 10.1.2.3) on the BABY HUG Internet Data Entry System. Upon selection of the type of specimen, the appropriate transmittal form appears on the screen for data entry. Transmitted forms must be entered by 10:00 a.m. (Eastern time) the day following specimen collection.

Limited information is recorded on the transmittal forms. At a minimum, the Clinical Center number, the specimen label number (see Section 7.2) and the dates of collection and shipment are recorded. Some transmittal forms require additional information about the specimen(s). No patient identifiers are recorded. Single or multiple specimens from one or more patients are allowed on a single transmittal form.

When printing the transmittal form, two copies are automatically printed; one copy should be kept in the patient's file and the other sent with the specimen(s). If a copy cannot be entered and/or printed out in time for the specimen to be shipped, then a copy of a handwritten form must be sent with the specimen. The shipping information is listed on the form. Most transmittal forms must be faxed to the core laboratory with the Federal Express tracking number before the shipment is sent. In addition, some core laboratories require contact before shipment is made to alert them of the upcoming shipment.

## **7.4 HEMATOLOGY and BIOCHEMISTRY**

### **7.4.1 Specimen Collection**

Peripheral/Capillary Blood is to be collected using **Standard Precautions**. The hematology and biochemistry specimens will be collected during screening, at treatment initiation, every six months after treatment initiation, and at exit.

#### **7.4.1.1 Hematology**

Hematology specimens will require two Microtainer® EDTA Lavender-top tubes filled to the 500 µL mark. One tube will remain at the Local Laboratory and one tube will be shipped to the

Medical College of Georgia (MCG) Core Laboratory as described below. Label the tube shipped to the MCG with a label provided by the Medical Coordinating Center (MCC). Please note that the blood for the Pitted Cell Count will be obtained from the Local Laboratory Hematology tube for the 6-month visit (06M).

#### **7.4.1.2 Biochemistry**

Except during screening, chemistry specimens will require two Microtainer® Red-top tubes filled to the 500 µL mark. Both tubes must be labeled with the same 5-digit number using the labels provided by the MCC. Screening specimens require 2 mL of blood.

#### **7.4.1.3 Urine Chemistry**

Urine chemistry specimens are to be collected during screening and at exit for Urine Osmolality. See Section 8.8 (Urine Concentrating Ability) for details on collection of the urine specimen; they are collected at the same time as the biochemistry specimen. Urine is to be transported in a Cryovial and shipped to the MCG Core Laboratory with the blood specimens. Please label the vial appropriately with a label provided by the MCC.

#### **7.4.2 Hemoglobin Electrophoresis**

Hemoglobin electrophoresis will be performed in the Hematology and Biochemistry Core Laboratory on blood specimen residuals available during the eligibility evaluations.

#### **7.4.3 Test Schedule**

Shown in Table 7-2 are the tests that will be performed, at which visit(s) they will be performed, and how much whole blood needs to be drawn at each visit. Some tests taken from an aliquot of the chemistry specimen (e.g., gel electrophoresis, ferritin, HPLC creatinine) require additional processing at the core laboratory; the Clinical Centers should allow one week for these results during the screening process.

**TABLE 7-2**

**Hematology and Biochemistry Specimen Test Schedule  
Core Laboratory Collection**

Test	Schedule			
	Screening	Treatment Initiation	Every 6 Months	Exit
HEMATOLOGY	0.5 ml	0.5 ml	0.5 ml	0.5 ml
CBC	X	X		X
Hb F%	X	X	X	X
F Cell Assay	X	X	X	X
BIOCHEMISTRY	2 ml	1 ml	1 ml	2 ml
Urea Nitrogen	X	X	X	X
ALT	X	X	X	X
Total Bilirubin	X	X	X	X
Direct Bilirubin	X	X	X	X
Calcium/Phosphorous/ Magnesium	X		X	X
Ferritin	X		X	X
HPLC serum creatinine		X	X	X
Serum Osmolality	X			X
Hemoglobin electrophoresis	X			
URINE				
Urinalysis	X			X

**7.4.4 Shipping Procedures**

1. Store the gel packs in the freezer in preparation for shipping specimens to the MCG Core Laboratory.
2. Place one frozen gel pack in the bottom of the Styrofoam-lined shipping box.
3. Put the tubes (hematology, biochemistry, and/or urine chemistry) in the foam insert located in the white plastic container, seal the plastic bag and tighten the orange lid.

4. Place the container inside the Styrofoam-lined shipping box on top of the frozen gel pack.
5. Place one frozen gel pack on top of the plastic container also.
6. Fill the void inside the shipping box with crumpled or shredded paper.
7. Cover the Styrofoam-lined box with the Styrofoam lid.
8. Fill out Transmittal Form 101 if shipping hematology specimens and Transmittal Form 102 if shipping biochemistry and urine specimens. Include the FedEx Tracking Number on the transmittal form(s). All specimens can be shipped together in the same box.
9. FAX the transmittal form(s) to Jeanette Harbin @ (706) 721-9637.
10. Insert the transmittal form(s) in the shipping box between the Styrofoam and the outer corrugated box.
11. Close the outer box and tape shut with appropriate shipping tape.
12. Attach a FedEx Airbill with the following address:

Jeanette Harbin (706) 721-9639  
Medical College of Georgia  
Hemoglobin Laboratory AC-1004  
1120 15<sup>th</sup> Street  
Augusta, GA 30912

13. If the shipment is not received in the MCG Core Laboratory at the expected time, the Laboratory Coordinator or designee will pursue tracking the shipment and notify the Clinical Center and the MCC.

## **7.5 CYTOGENETICS**

### **7.5.1 Specimen Collection and Shipment**

1. Collect 4 mL of peripheral blood in a green top Sodium heparin vacutainer. Mix blood well by inverting the tube several times.
2. Affix one of the child's designated BABY HUG labels to the tube.
3. The tube will be shipped with the hematology and biochemistry specimens to the Hematology and Biochemistry Core Laboratory. Place the tube in the foam insert

located in the white plastic container (see Step 3 in Section 7.4.4, shipping instructions for hematology and biochemistry specimens).

4. Ship blood on the day of collection (or latest by the next morning - refrigerate overnight, do not freeze) to the Hematology-Biochemistry Core Laboratory:

Medical College of Georgia  
Hemoglobin Laboratory AC-1004  
1120 15<sup>th</sup> Street  
Augusta, GA 30912  
ATTN: Jeanette Harbin, (706) 721-9639

The Hematology-Biochemistry Core Laboratory is responsible for transporting the specimen(s) to the Cytogenetics Laboratory.

5. Fill out Transmittal Form 105, including the FedEx Tracking Number.
6. FAX the transmittal form to Jeanette Harbin @ (706) 721-9637.
7. Place the transmittal form in the shipping box between the Styrofoam and the outer corrugated box.
8. Please notify Dr. Anita Kulharya or Ms. Patricia Miller (Laboratory Coordinator) of the date you are sending the specimen, the Clinic Center Name with Contact Person and Phone Number.

Phone: (706) 721-4708 (preferred)  
E-mail: [akulhary@mail.mcg.edu](mailto:akulhary@mail.mcg.edu)  
With cc to: [pmiller@mcg.edu](mailto:pmiller@mcg.edu)

9. The specimens should be sent Priority Overnight via FedEx Monday through Thursday for delivery Tuesday through Friday.
10. If the specimen is not received at the expected time, shipment-tracking procedures will be pursued and the Clinical Center and C-TASC will be notified.

### **7.5.2 Processing Specimens**

1. The specimen will be accessioned into the laboratory records and a unique laboratory number will be assigned for cross-reference.
2. For each specimen, two lymphocyte cultures will be initiated in complete RPMI 1640 culture medium containing the T-cell mitogen Phytohemagglutinin (PHA). Because individual response to the mitogen varies, two doses (1X and 2X) doses of PHA will be used.

3. Cell cultures will be incubated at 37°C for 72 hours.
4. After appropriate incubation, they will be harvested and chromosome slides will be prepared. For each specimen 4-5 slides will be prepared.
5. Two slides will be Trypsin Giemsa banded (G-band) for karyotype analysis. Twenty to twenty-five metaphases will be analyzed in detail for structural and/or numerical abnormalities.
6. Two slides will be solid stained, also with Giemsa stain. These slides will be analyzed for chromatid breaks, chromosome breaks, fragments, exchanges, rings, dicentrics, etc. One hundred metaphases will be analyzed to calculate the break/cell.
7. All data will be documented by records and photographs as necessary.
8. Complete cytogenetics reports will be sent to the Medical Coordinating Center in three working weeks.

## **7.6 MUTATIONS**

### **7.6.1 Process for the first 140 patients**

The following procedure will be followed for patients 1 - 140.

1. Collect 3 mL of peripheral blood in an EDTA lavender-top vacutainer. This specimen can only be collected Monday - Thursday.
2. Affix one of the child's designated BABY HUG labels to the tube.
3. Fill out Transmittal Form 106, including the FedEx tracking number.
4. Fax the transmittal form to Thad Howard at (901) 495-4723.
5. Place a cold (not frozen) gel pack above and below the styrofoam package.
6. Place the transmittal form in the shipping box between the styrofoam and the outer corrugated box.
7. Ship at room temperature the day of collection using overnight delivery to:

Thad Howard  
Room D5052, Danny Thomas Research Center  
St. Jude Children's Research Hospital  
332 North Lauderdale St.  
Memphis, TN 38105

## 7.6.2 Process for patients 141 - 200

1. For blood specimens for patients 141-200, 1ml of blood will be shipped to the DNA Core Laboratory at the Medical College of Georgia for DNA extraction only.
2. Collect 1ml of peripheral blood in an EDTA lavender top vacutainer (Monday - Thursday only).
3. Affix one of the child's designated BABY HUG labels to the tube.
4. Fill out Transmittal form 106, including the Fedex tracking number.
5. Fax the transmittal form to Jeanette Harbin at 706-721-9637.
6. Insert the transmittal form(s) in the shipping box between the styrofoam and the outer corrugated box.
7. Close the outer box and tape shut with appropriate shipping tape.
8. Attach a FedEx Airbill with the following address:

Jeanette Harbin (706) 721-9639  
Medical College of Georgia  
Hemoglobin Laboratory AC-1004  
1120 15<sup>th</sup> Street  
Augusta, GA 30912

9. If the shipment is not received in the MCG Core Laboratory at the expected time, the Laboratory Coordinator or designee will pursue tracking the shipment and notify the Clinical Center and the MCC.
10. This specimen can only be collected Monday through Thursday and should be shipped at room temperature the day of collection using overnight delivery.

## 7.7 PITTED CELLS

### 7.7.1 Preparation of Whole Blood Sample for Pitted Red Blood Cell Count

\*\*\*IMPORTANT: The pitted cell count sample should be prepared within one hour of collection of the blood sample into the EDTA lavender-top tube.\*\*\*

1. After the patient's whole blood sample is drawn and placed in an EDTA lavender-top tube, the sample is immediately used for preparation of the sample for the pitted cell count. It is preferable to use the local CBC blood sample.
2. Put on gloves.



3. **\*\*Gently invert the lavender-top tube of patient blood 10 times to mix the sample.\*\***
4. Remove stopper from the tube of blood.
5. Hold the provided plastic pipette vertically, squeeze the bulb and insert into the specimen. Carefully remove a small amount of the patient sample. Use a clean pipette for each patient sample. Wipe excess blood off of the outside of the pipette.
6. Place TWO SMALL DROPS (approximately 50 microliters) of the EDTA lavender-top tube blood into the plastic tube provided containing glutaraldehyde.
7. Recap the plastic glutaraldehyde tube firmly.
8. Gently invert the tube of blood/glutaraldehyde mixture ten times to ensure mixing of specimen. Place into specimen bag.
9. Recap the EDTA lavender-top tube. Discard the pipette into a biohazard container.
10. Label the glutaraldehyde tube and bag with one of the child's BABY HUG five-digit label numbers. On a blank label provided by the MCC, write the date and time of preparation, and the initials of the person who prepared the sample. Record the same information on Transmittal Form 103.
11. Place the prepared sample in a refrigerator at 2° - 8° centigrade for storage until shipping. Samples may be shipped singly or batched, but shipping must be accomplished within two weeks of collection.
12. The EDTA lavender-top tube can be recapped and submitted to your clinical laboratory for the local CBC (preferred) or to the Hematology and Biochemistry Core Laboratory for additional analyses.

### **7.7.2 Shipping Procedure**

**\*\*\* Please ship specimens on Monday through Thursday ONLY \*\*\***

1. Please contact Beth Smith to notify her of your intent to ship the (batched) specimen(s).
  - a. Email contact [beth.smith@childrens.com](mailto:beth.smith@childrens.com) preferred.
  - b. Backup telephone number 214-456-2885 or if no answer 214-456-6065.
2. Put the gel packs into the freezer to prepare.

3. Await telephone or email response (will occur within 1 working day) before shipping specimens.
4. If you do not receive a response to 2 separate messages please contact Leah Adix (BABY HUG Data Manager) at 214-456-2888 or if unable to reach her, Zora R. Rogers, M.D. (Pitted Cell Count Core Laboratory PI) via 214-456-6102 to schedule the shipping.
5. Ship using the IATA provided cold pack container with gel packs to arrive the next morning (Tuesday - Friday only) to:

Beth Smith MT (ASCP)  
Special Testing Laboratory  
Children's Medical Center of Dallas  
1935 Motor St., D200  
Dallas, Texas 75235
6. Enclose one copy of Transmittal Form 103 with sample(s). Be sure that the initials of the person preparing the pit count are on the transmittal form.
7. FAX a copy of the transmittal form to Leah Adix (BABY HUG Data Manager) at 214-456-8469.
8. We will notify you upon receipt if specimens are not acceptable and need to be recollected at your next contact with patient.

## **7.8 IMMUNOLOGY**

### **7.8.1 Introduction and Rationale**

Hydroxyurea reversibly inhibits ribonucleotide reductase, leading to cell cycle arrest at the G1-S interface. Patients with sickle cell disease demonstrate an increased susceptibility to infection with encapsulated bacteria, particularly *Streptococcus pneumoniae*. Children in BABY HUG are in a sensitive period of development for the immune system. By introducing an anti-proliferative drug such as hydroxyurea during a sensitive period of development for the immune system, it is possible that adverse effects on development of the repertoire of antibody production or T-cell recognition could occur. Conversely, improvement in splenic function due to hydroxyurea could lead to enhanced responses to vaccination. As immunizations are an essential part of care for sickle cell disease, it will be important to document any effects that hydroxyurea has on the immune system and response to vaccination.

**Goals:**

- 1) Assess effectiveness of immunization with measles/mumps/rubella (MMR) and pneumococcal conjugate (Prevnar™) and pneumococcal polysaccharide (Pneumovax™ 23 or Pnu-Imune™-23) vaccines.
- 2) Assess possible adverse effects on development of antibody production and T-cell number.
- 3) Ensure adequate vaccination status for all infants and children in BABY HUG.

**Procedures:**

- 1) Provide an accurate record of immunizations for patients on the trial.
- 2) Collect necessary (timed) specimens for immunologic assays planned as part of the trial.

**7.8.2 Recording Immunizations on Form 42**

At the time of screening:

1. Review the chart and immunization records.
2. Contacting the parents and pediatrician, if necessary, document which immunizations have already been given.
3. Record the actual dates that immunizations are given.

*Note: The term "Sequence in series" indicates times that vaccinations are recommended. These ages may not correspond to the ages the immunizations are actually given. When giving combination vaccines, record each component as a separate vaccination in record; e.g., for COMVAX, Hemophilus influenzae and Hepatitis B vaccinations would be recorded in two different series.*

Ongoing:

1. At each study visit (Form 31), inquire if any immunizations have been given since the previous study visit.
2. On Form 42, record the actual dates that immunizations are given.

### 7.8.3 Schedule of Blood Tests

For convenience, a summary of blood test and volumes, and when they should be drawn is shown in Table 7-3. All volumes are in milliliters (ml).

**TABLE 7-3**  
**Immunology Blood Tests and Volumes**

Test (ml whole blood)	Entry (Pre- Treatment)	12.5-16.5 mos. of age	20-24 mos. of age	24.5-26 mos. of age	Exit
Pneumococcal antibody/ Serum opsonophagocytic	3.0		3.0	3.0	3.0
MMR antibody		1.2*	1.2		1.2
CD4, CD8 T-Cells	0.5		0.5		0.5
Total blood volume	3.5	1.2	4.7	3.0	4.7

\*If not immunized - immunize, wait 2-6 weeks, then collect

The 12.5 –16.5 month draw is intended to be immediately (2-8 weeks) after the MMR is given. The 20-24 month draw is intended to be immediately (roughly 2-17 weeks) before the 23-valent pneumococcal vaccination (Pneumovax™ or Pnu-Imune™) is given. The 24.5-26 month draw is intended to be immediately (2-8 weeks) after the 23-valent pneumococcal is given.

### 7.8.4 Specimen Collection, Preparation and Shipment

#### 7.8.4.1 Pneumococcal Antibody/Serum Opsonophagocytic Assays

\*\*\* IMPORTANT: Draw the *20-24 month sample* immediately before the 23-valent pneumococcal vaccination (Pneumovax™ or Pnu-Imune™) is given. Draw the *24.5-26 month sample* immediately (2-8 weeks) after the 23-valent pneumococcal vaccine is given.

\*\*\*

For all samples:

1. Draw 3 ml of blood into a small red top (no anticoagulant) tube.
2. Hold the red top tube at room temperature for 15-30 min (but not longer).
3. Centrifuge at 4° C for 10 min in a refrigerated centrifuge at 400xG (approximately 1500 RPM in most table top centrifuges) to separate the serum. If serum separation and recovery is not complete (less than 50% of initial volume), the sample can be re-spun, using the same conditions to recover more plasma. Centrifuge speeds are

approximate, and can also be varied with the first or second spins to improve recovery, to optimize for the equipment being used.

4. Remove the serum without disturbing the red cell pellet using a pipette, and transfer in 0.5 ml aliquots to freezer vials (NUNC CryoTube polypropylene vials, Ext, starfoot, round 1.0 ml size, Cat # 375353)
5. Label the tube using a freezer-safe label provided by the Medical Coordinating Center (MCC).
6. Freeze the samples in the 1.0 ml freezing vials and store at -70° C.
7. Batch the samples and ship to the laboratory every month on dry ice pellets by overnight carrier in the Styrofoam container supplied. Include a completed Transmittal Form 108.
8. The laboratory should be notified by e-mail the night of shipment. Shipment should be done only Monday through Thursday.

The shipping address for pneumococcal antibody/serum opsonophagocytic assays is:

Howard Lederman, MD, PhD  
Pediatric Immunology Laboratory  
Johns Hopkins Hospital - CMSC 11-106  
600 N. Wolfe Street  
Baltimore, MD 21287-3923  
Phone: 410-955-5883  
Fax: 410-955-0229

Email: [Hlederm1@jhem.jhmi.edu](mailto:Hlederm1@jhem.jhmi.edu) and [aswift@jhmi.edu](mailto:aswift@jhmi.edu) (address both individuals)

#### **7.8.4.2 MMR Antibody Studies**

\*\*\* IMPORTANT: *Draw the 12.5 –16.5 month sample immediately (2-8 weeks) after the MMR is given.*\*\*\*

1. Draw 1.2 ml of blood into a red top (no anticoagulant) tube.
2. Label the tube using a label provided by the MCC.
3. Ship the sample to the laboratory at room temperature in the same red top tube, with or without other specimens, in the Styrofoam container supplied. Include in the styrofoam container a cold (not frozen) gel pack. Also include a completed Transmittal Form 107. (If it is advantageous to the clinical center, serum can be separated as with the pneumococcal antibody/serum opsonophagocytic assays and

frozen at – 70° C, and can be batched for shipping to Johns Hopkins at 1 month intervals.)

4. The laboratory should be notified by e-mail the night of shipment. Shipment should be done only Monday through Thursday.

MMR antibody samples should be shipped to:

Howard Lederman, MD, PhD  
Pediatric Immunology Laboratory  
Johns Hopkins Hospital - CMSC 11-106  
600 N. Wolfe Street  
Baltimore, MD 21287-3923  
Phone: 410-955-5883  
Fax: 410-955-0229

Email: [Hlederm1@jhem.jhmi.edu](mailto:Hlederm1@jhem.jhmi.edu) and [aswift@jhmi.edu](mailto:aswift@jhmi.edu) (address both individuals)

#### 7.8.4.3 T-Cell Enumerations

1. Draw 0.5 ml of blood into a 1 ml purple top (EDTA) tube (this is an absolutely minimum volume - please do not under fill).
2. Label the tube using a label provided by the MCC.
3. Ship the sample to the laboratory at room temperature in the same purple top tube, with or without other specimens, in the Styrofoam container supplied. Include a 4° C (not frozen) gel pack in the Styrofoam container, to arrive within 24 hrs. Shipping should be done for early AM delivery the next day after drawing, Monday through Thursday only. Longer time periods will jeopardize results. Include a completed Transmittal Form 109.
4. The laboratory should be notified by e-mail the night of shipment.

T cell enumerations should be shipped to:

Dr. Michael Borowitz  
Johns Hopkins Medical Institutions  
Flow Cytometry Lab  
Weinberg Building - Room 2306  
401 N. Broadway  
Baltimore, MD 21231  
Fax:410-614-2912

## 7.9 PHARMACOKINETIC (PK) ANALYSIS

### 7.9.1 Specimen Collection

All incoming patients will have entry and exit PK studies, all patients currently enrolled in the study will have exit PK studies, and all patients will have PK studies at approximately one month on study treatment.

#### 7.9.1.1 Entry and Exit Studies

The entry and exit studies will be done using the same blood draws needed for the DTPA/GFR study; no additional blood will be drawn for these PK studies. Specifically, 30 minutes after the DTPA is injected into the child, the child's daily dose of study treatment will be administered. Thirty minutes later (i.e., one hour after the DTPA was administered), the first blood specimen will be drawn with two more specimens drawn at the 2-hour and 4-hour post DTPA time points. This will yield three PK specimens at 30, 90, and 210 minutes (see Figure 7-1).

Figure 7-1

Overlay of the Entry and Exit PK Studies on the DTPA Procedure

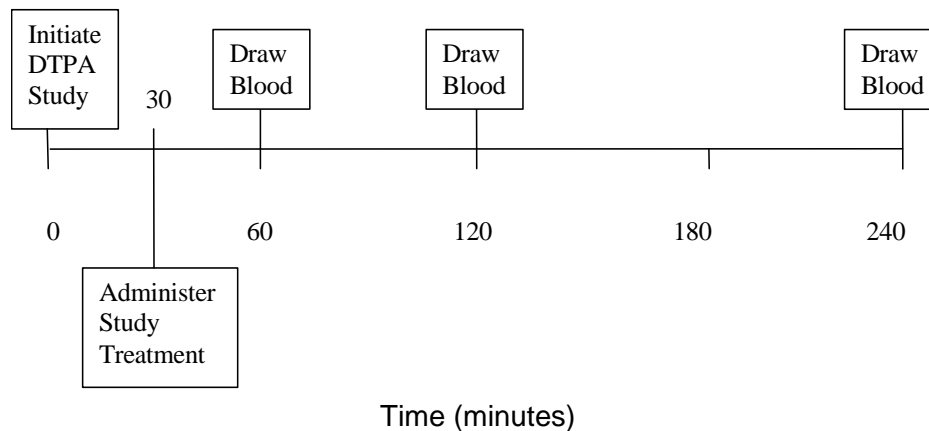

All attempts should be made to obtain all three specimens. Note that different 5-digit label numbers must be used for labeling the different time point collections. For the exit PK study, the Clinical Center staff should instruct the caregiver to administer the previous day's dose at least 12 hours prior to the child's visit. In addition, the pharmacist should mix a new bottle of study treatment on the day of the DTPA/GFR procedure; the administered dose should be from this bottle.

- 30-Min: The plasma residuals from the 1-hour DTPA assay of GFR (see Section 8.3) will be used for the 30-minute PK assay. After DTPA measurement, combine the two aliquots of plasma into a single cryovial. At least 3 days of storage is needed for the radiation to decay. Label the cryovial with the same 5-digit label number as that used for the 1-hour DTPA sample.
- 90-Min: Follow the same procedure as for 30-minute, but use the plasma residuals from the 2-hour DTPA assay of GFR. Label the cryovial with the same 5-digit label number as that used for the 2-hour DTPA sample.
- 210-Min: Follow the same procedure as for 30-minute, but use the plasma residuals from the 4-hour DTPA assay of GFR. Label the cryovial with the same 5-digit label number as that used for the 4-hour DTPA sample.

Keep all labeled cryovials in a -20° C freezer.

#### **7.9.1.2 One-Month Post-Treatment Initiation**

For the repeat PK studies at approximately one month on study treatment, the patients will be administered their daily dose of study treatment followed by two blood draws at 30 minutes and 90 minutes post-study treatment administration. Clinical Center staff should instruct the caregiver to administer the previous day's dose at least 12 hours prior to the child's appointment.

- 30-Min: Draw 2 ml of whole blood into an EDTA lavender-top tube. Affix one of the child's designated 5-digit label numbers to the tube. Spin the tube down and decant the plasma into a cryovial. The exact time of the blood draw must be recorded on the study form.
- 90-Min: Follow the same procedure as for 30-minute, but use a different label number.

Keep both labeled cryovials in a -20° C freezer.

#### **7.9.2 Specimen Packing**

TBD

#### **7.9.3 Shipping Procedure**

TBD



## 7.10 BIOMARKERS

### 7.10.1 Specimen Collection and Preparation

Specimens should not be collected on a Friday since lab work cannot be performed on Saturday. Note that different 5-digit label numbers must be used for labeling the different tubes.

1. From a free-flowing blood draw, withdraw into a plastic 1ml syringe 500µl blood. Change the syringe to a second 1ml syringe which should be filled.
2. The first 500µl of whole blood should be placed in a Microtainer® EDTA Lavender-top tube and shaken by an associate for 3 to 5 minutes such that the blood in the bullet does not clot (**Tube A**).
3. The 1ml blood from the second syringe should be equally divided between a second Microtainer® EDTA Lavender-top tube (**Tube B**) and a plastic microfuge tube (with ACD anti-coagulant **Tube C** provided by the **Biomarker Lab**). Tubes should be well shaken to prevent clotting.
4. From **Tube A** withdraw **100µl** blood with a Rainin pipette and place in a thick-walled empty plastic microfuge tube and **immediately** freeze at  $-70^{\circ}\text{C}$ . Affix one of the child's 5-digit label numbers to the tube prior to freezing. These quick frozen tubes can be batched and sent FedEx on **dry ice** once in 6 weeks to the **Biomarker Lab**.
5. Label each of the two EDTA Lavender-top tubes (**Tubes A and B**) with a different 5-digit label number. The tubes should be then packed on **wet ice** the same day the blood was drawn and sent FedEx to arrive the next morning (**10AM priority**) at the **Biomarker Laboratories**.
6. **Tube C** (or the ACD microfuge with 500µl blood) should be spun within 60 minutes at 1000g for 10 minutes. The red cell pellet is discarded and the 1000g supernatant is then placed in a new plastic microfuge tube and respun at 10,000g for 10 minutes. The plasma supernatant is pipetted out and saved in a clean thick-walled plastic microfuge tube and frozen at  $-70^{\circ}\text{C}$ . Affix a 5-digit label number to the tube prior to freezing. These samples can also be batched and sent once in 6 weeks on **dry ice** to the **Biomarker Laboratory**, together with the other batched specimens (see #4 above).

### **7.10.2 Shipping Procedure**

All specimens must be shipped Monday through Thursday by Fed Ex to the following address. Include the appropriate transmittal form(s).

c/o Dr. B.N.Y. Setty  
Thomas Jefferson University  
Medical College Building, Suite #727  
1025 Walnut Street  
Philadelphia, PA 19107  
(215) 955-9820 PHONE      (215) 955-8011 FAX

EXHIBIT 7 - 1  
**BABY HUG Blood Specimen Collection Priorities**

<b>Eligibility</b>	<b>Priority</b>	<b>Measurement</b>	<b>Tube and Volume (ml)</b>	<b>Consequences</b>	<b>Comment</b>	
	1	Local Hematology	0.5 EDTA Lav	Not Eligible Unless Completed	Needed Only Once	
		Central Hematology	0.5 EDTA Lav		Needed Only Once	
		Biochemistry	2.0 Red		Needed Only Once	
	2	Cytogenetics	4.0 NA Hep Green	Not Eligible Unless Completed	Needed Only Once	
		Mutations DNA	3.0 EDTA Lav		Needed Only Once	
		Pitted Cells	0.1 EDTA Lav *		Needed Only Once	
	3	Immunology Antibody/Opsonin	3.0 Red	Not Eligible Unless Completed	Needed Only Once	
		T cells	0.5 EDTA Lav		Needed Only Once	
		Biomarkers	1.5 EDTA Lav and ACD (microfuge)		Optional	Ancillary Study Centers Only
<b>Treatment Initiation</b>						
	1	DTPA and PK Analysis	9.0 EDTA Lav	Critical Primary End Point Data Missing	No Chance to Recover	
		Local Hematology	0.5 EDTA Lav			Stop Order
		Central Hematology	0.5 EDTA Lav			
		Biochemistry	1.0 Red			
<b>Routine Visits</b>						
	1	Local Hematology	0.5 EDTA Lav	Stop Order		
	2	Immunology Antibody/Opsonin T Cells MMR	3.0 Red 0.5 EDTA Lav 1.2 Red	Reminder to Collect	Collect at Age Appropriate Time	
	3	Biomarkers	1.5 EDTA Lav and ACD (microfuge)	Optional	Ancillary Study Centers Only	

\*Special Prep

**Week 04 Visit**

1	PK Analysis	4.0 EDTA Lav
---	-------------	--------------

**6-12-18 Month Visits**

1	Pitted Cells	0.1 EDTA Lav *	Reminder to Collect	Needed Only Once
	Central Hematology	0.5 EDTA Lav		
	Central Biochemistry	1.0 Red		

**Study Exit (24 months)**

1	DTPA/PK Analysis	9.0 EDTA Lav	Critical Primary End Point Data Missing	No Chance To Recover
2	Cytogenetics	4.0 NA Hep Green	Must Be Obtained While on Study Treatment	Needed Only Once
	Mutations DNA	3.0 EDTA Lav (pts 1-140) 1.0 EDTA Lav (pts 141-200)	Must Be Obtained While on Study Treatment	Needed Only Once
	Pitted Cells	0.1 EDTA Lav *	Must Be Obtained While on Study Treatment	Needed Only Once
3	Immunology Antibody/Opsonin T Cells MMR	3.0 Red 0.5 EDTA Lav 1.2 Red	Must Be Obtained While on Study Treatment	Needed Only Once
	Biomarkers	1.5 Lav and ACD (microfuge)	Must Be Obtained While on Study Treatment	Ancillary Study Centers Only

\*Special Prep

## EXHIBIT 7-2

0125	BH: 13959	BH: 13959	BH: 13959	BH: 13959	BH: 13959	BH: 13959
1	BH: BDKFK	BH: BDKFK	BH: BDKFK	BH: BDKFK	BH: BDKFK	BH: BDKFK
0125	BH: 52654	BH: 52654	BH: 52654	BH: 52654	BH: 52654	BH: 52654
2	BH: FCGFE	BH: FCGFE	BH: FCGFE	BH: FCGFE	BH: FCGFE	BH: FCGFE
0125	BH: 09854	BH: 09854	BH: 09854	BH: 09854	BH: 09854	BH: 09854
3	BH: AKJFE	BH: AKJFE	BH: AKJFE	BH: AKJFE	BH: AKJFE	BH: AKJFE
0125	BH: 08253	BH: 08253	BH: 08253	BH: 08253	BH: 08253	BH: 08253
4	BH: AJCFD	BH: AJCFD	BH: AJCFD	BH: AJCFD	BH: AJCFD	BH: AJCFD
0125	BH: 59155	BH: 59155	BH: 59155	BH: 59155	BH: 59155	BH: 59155
5	BH: FKBFF	BH: FKBFF	BH: FKBFF	BH: FKBFF	BH: FKBFF	BH: FKBFF
0125	BH: 51858	BH: 51858	BH: 51858	BH: 51858	BH: 51858	BH: 51858
6	BH: FBJFJ	BH: FBJFJ	BH: FBJFJ	BH: FBJFJ	BH: FBJFJ	BH: FBJFJ
0125	BH: 48653	BH: 48653	BH: 48653	BH: 48653	BH: 48653	BH: 48653
7	BH: EJGFD	BH: EJGFD	BH: EJGFD	BH: EJGFD	BH: EJGFD	BH: EJGFD
0125	BH: 58159	BH: 58159	BH: 58159	BH: 58159	BH: 58159	BH: 58159
8	BH: FJBFK	BH: FJBFK	BH: FJBFK	BH: FJBFK	BH: FJBFK	BH: FJBFK
0125	BH: 29654	BH: 29654	BH: 29654	BH: 29654	BH: 29654	BH: 29654
9	BH: CKGFE	BH: CKGFE	BH: CKGFE	BH: CKGFE	BH: CKGFE	BH: CKGFE
0125	BH: 05451	BH: 05451	BH: 05451	BH: 05451	BH: 05451	BH: 05451
10	BH: AFEFB	BH: AFEFB	BH: AFEFB	BH: AFEFB	BH: AFEFB	BH: AFEFB
0125	BH: 44954	BH: 44954	BH: 44954	BH: 44954	BH: 44954	BH: 44954
11	BH: EEKFE	BH: EEKFE	BH: EEKFE	BH: EEKFE	BH: EEKFE	BH: EEKFE
0125	BH: 23656	BH: 23656	BH: 23656	BH: 23656	BH: 23656	BH: 23656
12	BH: CDGFG	BH: CDGFG	BH: CDGFG	BH: CDGFG	BH: CDGFG	BH: CDGFG
0125	BH: 35157	BH: 35157	BH: 35157	BH: 35157	BH: 35157	BH: 35157
13	BH: DFBFH	BH: DFBFH	BH: DFBFH	BH: DFBFH	BH: DFBFH	BH: DFBFH
0125	BH: 29555	BH: 29555	BH: 29555	BH: 29555	BH: 29555	BH: 29555
14	BH: CKFFF	BH: CKFFF	BH: CKFFF	BH: CKFFF	BH: CKFFF	BH: CKFFF
0125	BH: 24154	BH: 24154	BH: 24154	BH: 24154	BH: 24154	BH: 24154
15	BH: CEBFE	BH: CEBFE	BH: CEBFE	BH: CEBFE	BH: CEBFE	BH: CEBFE
0125	BH: 45353	BH: 45353	BH: 45353	BH: 45353	BH: 45353	BH: 45353
16	BH: EFDFF	BH: EFDFF	BH: EFDFF	BH: EFDFF	BH: EFDFF	BH: EFDFF
0125	BH: 46752	BH: 46752	BH: 46752	BH: 46752	BH: 46752	BH: 46752
17	BH: EGHFC	BH: EGHFC	BH: EGHFC	BH: EGHFC	BH: EGHFC	BH: EGHFC

**EXHIBIT 7-3**

**0101  
188**

**BABY HUG  
15712**

**BABY HUG  
15712**

**BABY HUG  
15712**

**BABY HUG  
15712**

**BABY HUG  
15712**

**BABY HUG  
15712**

**BABY HUG  
15712**

**BABY HUG  
15712**

**BABY HUG  
15712**

**BABY HUG  
15712**

**BABY HUG  
15712**

**BABY HUG  
15712**

**BABY HUG  
15712**

**BABY HUG  
15712**

**0101  
189**

**BABY HUG  
10917**

**BABY HUG  
10917**

**BABY HUG  
10917**

**BABY HUG  
10917**

**BABY HUG  
10917**

**BABY HUG  
10917**

**BABY HUG  
10917**

**BABY HUG  
10917**

**BABY HUG  
10917**

**BABY HUG  
10917**

**BABY HUG  
10917**

**BABY HUG  
10917**

**BABY HUG  
10917**

**BABY HUG  
10917**

**PEDIATRIC HYDROXYUREA PHASE III CLINICAL TRIAL (BABY HUG)  
MANUAL OF OPERATIONS**

**CHAPTER 8**

**PROCEDURES FOR SPECIAL STUDIES**

**8.1 LIVER-SPLEEN SCAN**

**8.1.1 Procedure**

Radiopharmaceutical:	99m Tc Sulfur Colloid.
Dose:	0.05 mCi/kg (preferred minimum dose 0.5 mCi; a dose of 1.0 mCi or more acceptable if that is the local practice).
Injection Site:	Direct venous administration. Scan should begin within 15 minutes of injection.
Equipment:	Large field of view camera.
Collimator:	Dual Detector (have consistent use of collimator type for a patient).
Computer Set up:	<b>400K Image:</b> Static 400 K counts, 256 X 256 byte mode. <b>Timed Image:</b> Static fixed time views for the same amount of time as the static 400K counts true posterior image.
Scanning Technique:	<ol style="list-style-type: none"><li>1. Patient in supine position on table. Collimator should be in contact with patient (anterior head touching or as close as possible).</li><li>2. 400K Image: <b>true anterior/posterior</b> views. Timed Image: <b>left anterior oblique/right posterior oblique</b> views (obliquity should create maximum separation of liver and spleen with minimal to no overlap of organs; record camera angle).</li></ol>
Quantitative Analysis:	<ol style="list-style-type: none"><li>1. 400K Image: Draw region of interest around spleen, then liver on the <b>anterior</b> view. Record counts, number of pixels in ROI, and counts/pixel for each organ. Take a picture.</li><li>2. 400K Image: Repeat the same for the <b>posterior</b> view. Take a picture.</li><li>3. 400K Image: Calculate the geometric mean counts of spleen and liver from both views (see Section 8.1.2). Do the same for counts/pixel. Take a picture or record on film.</li><li>4. 400K Image: Generate the total spleen to liver ratio (see Section 8.1.2) and the counts/pixel spleen to liver ratio. Take a picture(s) or record on film.</li><li>5. Timed Image: Repeat step 1 using <b>left anterior oblique</b> view.</li><li>6. Timed Image: Repeat step 1 using <b>right posterior oblique</b> view.</li></ol>

7. Timed Image: Calculate the geometric mean counts of spleen and liver from both views. Do the same for counts/pixel. Take a picture or record on film.
8. Timed Image: Generate the total spleen to liver ratio and the counts/pixel spleen to liver ratio. Take a picture(s) or record on film.

Processing Scans:

1. 400K Image:
  - Include proper identification
  - Label the anterior view #1.
  - Label the posterior view #2.
  - Label the anterior view with region of interest around spleen and liver with counts and counts/pixel recorded on the film as #3.
  - Label the posterior view with region of interest around spleen and liver with counts and counts/pixel recorded on the film as #4.
  - Label as #5 the geometric mean counts and the geometric mean counts/pixel of spleen and liver from both views.
  - Label as #6 the total counts and counts/pixel spleen to liver ratios.
  
2. Timed Image:
  - Include proper identification.
  - Label the left anterior oblique (LAO) view #7.
  - Label the right posterior oblique (RPO) view #8.
  - Label the LAO view with region of interest around spleen and liver with counts and counts/pixel recorded on the film as #9.
  - Label the RPO view with region of interest around spleen and liver with counts and counts/pixel recorded on the film as #10.
  - Label as #11 the geometric mean counts and geometric mean counts/pixel of spleen and liver from both views.
  - Label as #12 the total counts and counts/pixel spleen to liver ratios.

### 8.1.2 Calculations for Quantitative Assessment

The geometric mean counts of the spleen and the liver, and the spleen-liver ratio, will be recorded on the films and calculated according to the following formula.

$$\text{Spleen geometric mean} = \sqrt{AxC}$$

$$\text{Liver geometric mean} = \sqrt{BxD}$$

$$\text{Spleen-liver ratio} = \frac{\sqrt{A \times C}}{\sqrt{B \times D}}$$



where, for the total counts spleen-liver ratios (400K and Timed Images),

A = anterior (400K Image) or LAO (Timed Image) spleen count

B = anterior (400K Image) or LAO (Timed Image) liver count

C = posterior (400K Image) or RPO (Timed Image) spleen count

D = posterior (400K Image) or RPO (Timed Image) liver count

The counts/pixel geometric means and the spleen-liver ratios (400K Image and Timed Image) will also be calculated according to the above formula.

### **8.1.3 Labeling and Shipping of Film Sheets**

A hard copy of the liver/spleen scan film sheets must be sent to the Medical Coordinating Center (MCC). The MCC will forward all film sheets to two central reviewers to assess splenic uptake. Use the following procedure to label and ship all the film sheets. (See Section 7.3 for a discussion of shipping transmittal forms.)

1. Obscure all patient identifying information on all film sheets.
2. Affix to *each* film sheet a duplicate label with the same 5-digit number as affixed the BABY HUG study form requesting the scan. All film sheets must have the same label *number*. (See Section 7.2 for a discussion of film labels.)
3. Complete Transmittal Form 111 (Liver/Spleen Scan Transmittal List). Affix to it a duplicate label with the same 5-digit number as already affixed to the BABY HUG study form and the film sheets.
4. Send all film sheets and Transmittal Form 111 within 5 days of the film date via FedEx to the Medical Coordinating Center:

BABY HUG Coordinator  
BABY HUG Medical Coordinating Center  
Clinical Trials & Surveys Corp. (C-TASC)  
2 Hamill Road, Suite 350  
Baltimore, MD 21210-1874

## **8.2 ABDOMINAL SONOGRAM**

### **8.2.1 Procedure**

#### Scheduling and NPO Guidelines

Because it is preferable that patients be NPO (except for clear liquids) for six hours before the sonogram, schedule them as the first exam of the day. It is acceptable to give them clear liquids (Pedialyte, water, clear juices) as needed. No milk.

#### Probe Selection

Use the highest frequency, non-linear, probe that is available and that gives the best image quality.

#### Image Annotation

When the patient is not supine, note on the image the position that the patient is in (i.e., left decubitus, right decubitus, prone or upright).

#### Scanning Protocol

- A. Gall Bladder
  1. With the patient in the supine position, take multiple longitudinal and transverse images representative of the entire gallbladder.
  2. With the patient in either the left or right lateral decubitus position, take multiple transverse and longitudinal images representative of the entire gallbladder.
  3. If there appears to be gallbladder wall thickening (above 3 mm) measure the gallbladder wall on a transverse image and obtain a color Doppler image of the gallbladder wall.
  4. Measure the diameter of the common bile duct (CBD) in the region of the porta hepatitis. Confirm that you are measuring the CBD with color Doppler.
- B. Liver
  1. Include one longitudinal image of the liver obtained with the right kidney in the field of view. The image should be obtained through the middle portion of the kidney and/or where the greatest kidney length can be obtained. Please include a longitudinal measurement of the liver at this location.

C. Spleen

1. Obtain measurements during relaxed respiration.
2. In the coronal plane, measure the greatest length and AP diameter at the hilum of the spleen.
3. In the transverse plane measure the greatest transverse diameter of the spleen at the level of the hilum.
4. Multiply the above three measurements together then multiply the result by a factor of 0.6 to obtain an estimate of spleen volume.

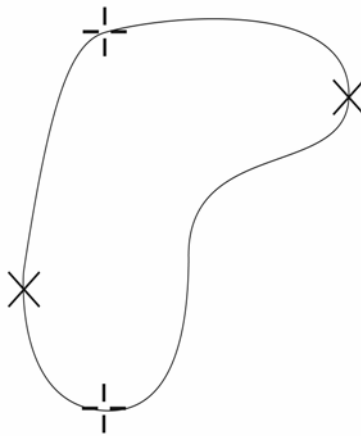

Example of a longitudinal spleen image. Note the correct placement of the cursors for anterior-posterior measurement (+) and longitudinal measurement (X).

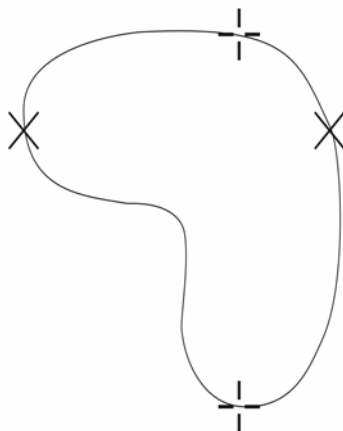

Example of a transverse image of the spleen. Note the correct cursor placement for anterior-posterior measurement (+) and transverse measurement (X).

D. Kidneys

1. In the supine position obtain a longitudinal image of each kidney with the liver and spleen in the field of view in order to compare renal echogenicity to liver/spleen echogenicity.
2. For the remainder of renal scanning, place the pt prone whenever possible. Alternatively, if necessary, scan in the upright position, with the probe on the patient's back. If unable to scan with a posterior approach, scan the kidneys in the supine position. Obtain the following:
  - a. Longitudinal images representative of the entire kidney;
  - b. Transverse images representative of the entire kidney;
  - c. Maximum renal length measurements;
3. Maximum transverse measurement at the level of the renal hilum;
4. Maximum anterior-posterior measurement in BOTH the longitudinal and transverse planes.

### 8.2.2 Labeling and Shipping of Film Sheets

A hard copy of the abdominal sonogram film sheets (no more than 12 images per sheet) must be sent to the Medical Coordinating Center (MCC). The MCC will forward all film sheets to a central reviewer. Use the following procedure to label and ship all the film sheets. (See Section 7.3 for a discussion of shipping transmittal forms.)

1. Obscure all patient identifying information on all film sheets.
2. Affix to each film sheet a duplicate label with the same 5-digit number as affixed the BABY HUG study form requesting the sonogram. All film sheets must have the same label *number*. (See Section 7.2 for a discussion of film labels.)
3. Complete Transmittal Form 112 (Abdominal Sonogram Transmittal List). Affix to it a duplicate label with the same 5-digit number as already affixed to the BABY HUG study form and the film sheets.

4. Send all film sheets and Transmittal Form 112 within 5 days of the film date via FedEx to the Medical Coordinating Center:

BABY HUG Coordinator  
BABY HUG Medical Coordinating Center  
Clinical Trials & Surveys Corp. (C-TASC)  
2 Hamill Road, Suite 350  
Baltimore, MD 21210-1874

### **8.3 RENAL GFR/DTPA CLEARANCE**

#### Radiopharmaceutical

99mTc-DTPA (prepared day of administration and used within 8 hours of preparation)

#### Patient Dose

500  $\mu$ Ci

#### Patient Preparation

Good oral hydration

**Intravenous catheter (placed with good IV access. This catheter may be used for both injection of DTPA as well as all 3 blood sample withdrawals.)**

#### Equipment

Dose calibrator

GFR data sheet (Exhibit 8-1)

5ml #11 test tubes

0.5 ml automated pipette

Syringes

Two 1cc syringes - one for standard and one for dose

Six 3cc syringes- 2 for each blood draw sample (1, 2 and 4 hours)

Centrifuge capable of 3000 RPM

500 ml flask

Well counter capable of counting 140 KeV

Computer with GFR program (optional)

Two T-connectors with associated tubing (max length of 3-4")

#### Well Counter Set-up

Use 99mTc (20%) window (i.e., 126 KeV – 156 KeV)

Count all samples for 1 minute (all at the same time, or one immediately after the other)

## GFR Technique

The same individual should mix the standard, dose, do all the counting, etc. for a patient's procedure. The standard and dose should be prepared just prior to injection. Record all measurements and times on the Renal GFR/DTPA Clearance Worksheet provided in Exhibit 8-1.

### Making the Standard

1. Take 500 ml of water in 500 ml flask.
2. Measure 100  $\mu\text{Ci}$  (or + 10%) of  $^{99\text{m}}\text{Tc}$ -DTPA in a dose calibrator in a 1 cc syringe (the standard).
3. Mix the  $^{99\text{m}}\text{Tc}$ -DTPA with the water and record the exact time of the mixing. This is the standard.
4. Within 5 minutes of mixing the standard, measure the remaining dose in the standard syringe. Record in  $\mu\text{Ci}$  and the exact time of the measurement.

### Making the Patient Dose and Injecting the Patient

1. Draw up the patient dose (500  $\mu\text{Ci}$  or + 10%). Record in  $\mu\text{Ci}$  and the exact time the dose was measured.
2. Within 15 minutes of drawing up the dose, inject the patient and record the exact time of administration. **Utilize the T-connector for injection of the DTPA. Flush with at least 5 cc saline followed by standard heparin lock flush.**
3. Remove the T-connector and tubing. Measure the remaining dose **in the T-connector, tubing and syringe**. Record in  $\mu\text{Ci}$  and exact time of measurement.\*
4. Immediately install a new T-connector.
5. **If injection of the DTPA is done in the nuclear medicine department, obtain 1 minute posterior image of kidneys and the injection site at 1-2 minutes post injection (can be done as one image if arms/hands placed down at patient's side).**
6. NOTE: if there is any extravasation of the patient dose, discontinue the GFR test. It will need to be rescheduled at least 72 hours later.

---

**\*Note:** If the standard and the patient dose are not prepared just prior to the injection, then they should be corrected for decay.

### Blood Draw Samples Technique

1. Use a 3cc syringe and withdraw 3 cc of blood; discard this (to prevent dilution from saline flush/heparin).
2. Use another 3 cc syringe and withdraw 3cc of blood (pure) and place in an EDTA lavender top tube to prevent blood from clotting.
3. Take a total of three 3 ml blood samples: one each at 1, 2, and 4 hours post injection. Label each hourly blood specimen with a *different* five-digit label number assigned to that patient. Record exact times of each blood draw.

### Counting the Samples

1. Within 5 minutes of drawing the last blood sample, centrifuge all 3 blood samples at room temperature for 10 minutes at 3000 RPM. This will yield the 3 plasma samples.
2. For each plasma sample, divide plasma into two aliquots (0.5 ml each) and place each 0.5 ml aliquot in a separate test tube (must be able to be placed into the well counter for counting). Affix to both counting tubes duplicate labels for that hourly sample.
3. Place 0.5 ml aliquots of the standard from the 500 cc flask (see step #3 in Making the Standard) into two test tubes. (Note: the plasma and standard aliquots must be of the same volume.)
4. Measure 2 aliquots of 0.5 ml sterile water and place each aliquot in a separate test tube. This is for the room background measurement.
5. Now **individually** count all 6 samples of plasma, 2 test tubes of standard and 2 test tubes sterile water in a well counter for 1 minute **each**. (Counting should begin within 30 minutes of obtaining the last blood sample.)
6. Record individual count values on the Renal GFR/DTPA Clearance Worksheet (see Exhibit 8-1). Enter the data into computer with a GFR software program and calculate the GFR.

## **8.4 NEUROLOGICAL ASSESSMENT**

The BABY HUG neurological examination is a subset of the Neurological Examination for Children (NEC). The NEC is a structured examination that was initially developed to assess neurologic abnormalities associated with HIV infection; it is also appropriate for other conditions. The items comprising the NEC tap several domains, including tone, power, reflexes, symmetry, and movement disorders. The majority of items (e.g., reflex and tone assessments) are applicable to children of all ages. The neurologic assessment will be performed at screening, 12 months and 24 months (the end of the study treatment).

The neurological test administrator must be BABY HUG certified before the BABY HUG neurological examination and questionnaire can be administered (see Section 11.4.5 for certification requirements).

### **8.4.1 General Instructions**

The neurological examination should be performed with the child fully awake since other states may affect responses. Sleepiness is associated with diminished muscle tone and sluggish or absent reactions. Irritability and crying may increase resting tone.

#### Appropriate State

To increase the validity and reliability of the examination, items should be administered only when the child is in the appropriate state for the item. If the child does not attain this state during the examination, the item should be noted as “Not able to assess.”

Every effort should be made to relax the child prior to and during the examination to ensure that all items can be administered. If the appropriate state cannot be attained for most items because the child is crying or uncooperative, the examination should be rescheduled.

#### Clothing

The child should wear only diapers, underclothes or a tight top and shorts.

#### Assistant

You will need an assistant to assess items which require that the child be in a sitting position. This assistant may be the parent, caretaker or other helper.

### **8.4.2 History from Caretaker**

- Ask: Which hand does your child prefer to use?



Probe, if necessary, as to which hand the child uses while eating, reaching for objects, etc.

- Ask: Does your child have tingling, numbness, pins and needles or a burning sensation in his or her hands or feet?

Code paraesthesia as present (2), if the symptoms lasted several hours or longer. If symptoms are present, inquire about the date and circumstances of onset.

- Ask: Has your child ever had a seizure or a convulsion?

Probe as to whether the seizure or convulsion was febrile and/or afebrile, the total numbers of febrile and afebrile seizures.

### **8.4.3 Reflexes**

Tap each firmly three times and record the maximal response. If there is no response in three taps, tap five more times and record the maximal response.

Regardless of the reflex being elicited, the goal is to stretch the child's limb just until a little bit of resistance is felt in the relaxed position.

#### Biceps Reflex

Position: Child seated or supine with head midline, arms semiflexed

Equipment: Tomahawk reflex hammer

State: Awake, no crying

1. Hold the child's arm at the elbow with the forearm semiflexed.
2. Place the finger of one hand on the biceps tendon in the antecubital fossa.
3. With the other hand, tap your finger with the reflex hammer.
4. Note whether or not the child's biceps muscle contracts and the presence or absence of clonus.

#### Knee Jerk

Position: Child seated or supine with head midline, legs semiflexed

Equipment: Tomahawk reflex hammer

State: Awake, no crying

1. When the child is seated, optimal stretch may be obtained when the child's knees are draped over the edge of the seat or the side of the assistant's thigh (that is, the child should be seated sideways on the assistant's lap).

2. When the child is supine with head midline, optimal stretch may be obtained when the child's knees are supported on your forearm in a semiflexed position.
3. Tap the middle of the quadriceps tendon just below the patella with the reflex hammer.
4. Note whether or not the quadriceps muscle contracts and the presence of absence of clonus.

### Ankle Jerk

Position: Child seated or supine with head midline

Equipment: Tomahawk reflex hammer

State: Awake, no crying

1. When the child is seated, optimal stretch may be obtained when the child's knees are draped over the edge of the seat or the side of the assistant's thigh.
2. When the child is supine with head midline, rotate one thigh outward and flex the knee.
3. Hold the child's foot by placing your thumb on the dorsum and your fingers on the sole of the foot (or vice versa, i.e., fingers on dorsum, thumb on sole). Dorsiflex the foot slightly.
4. With your other hand, tap the back of the Achilles tendon with the hammer. If there is no response, tap the part of your hand that is on the sole of the foot.
5. Note whether or not the gastrocnemius contracts and the presence or absence of clonus.

### Ankle Clonus

Position: Child seated or supine with head midline

State: Awake, no crying

1. When the child is seated, optimal stretch may be obtained when the child's knees are draped over the edge of the seat or the side of the assistant's thigh.
2. When the child is supine with head midline, rotate one thigh outward and flex the knee.
3. With one hand, hold the child's foot just above the ankle to secure it in place. With your other hand, grasp the foot at the root of the toes. Dorsiflex the foot abruptly.

4. Observe for clonus, rhythmic jerking of the foot of low amplitude and high frequency. If clonus occurs, count the number of beats.
5. Repeat this procedure on the same side.
6. If one to four beats are elicited on both trials, code "2." If five or more beats are elicited on either trial, code "3." If clonus occurs without stimulation, code "spontaneous clonus" (4).

#### Crossed Adductor Response

Position: Child supine with head midline and legs straight or seated with legs semiflexed

Equipment: Tomahawk reflex hammer

State: Awake, no crying

1. When the child is seated, the knees should be draped over the edge of the seat or assistant's thigh and the legs should be separated slightly.
2. When the child is supine with head midline, the child's legs should be separated slightly, externally rotated at the hips and semiflexed at the knees.
3. Place one finger over the distal tendon of the adductor muscle just above the knee.
4. Tap your finger with the reflex hammer.
5. The crossed adductor reflex is present (2) when the tapping elicits a contraction of the contralateral adductor muscle.
6. Code the response by the site of tapping (not the site of contraction). For example, right crossed adductor reflex is defined as response in the left adductor when you tap the right adductor.

#### Upgoing Toe

Position: Child seated or supine with head midline

Equipment: Tomahawk reflex hammer

State: Awake, no crying

1. Scratch the plantar surface of the foot with your thumbnail or the metal end of the reflex hammer. The scratch should begin at the heel and move forward along the lateral border of the sole, crossing over the metatarsals to the base of the big toe.
2. Repeat this procedure.

3. Note whether, on either procedure, the big toe does not go up (1) or goes up (2).
4. An upgoing toe can also be a withdrawal response with concomitant dorsiflexion of the foot and leg withdrawal. If withdrawal is elicited, repeat the maneuver up to five times. If two informative trials are not obtained in five tries, code “two informative trials not obtained” (3).

#### **8.4.4 Crawling and Walking**

Observe the child in diapers, underclothes or in tight top and shorts.

Equipment: Mat (3' x 6') and toy or lollipop

State: Awake

##### **8.4.4.1 Child Does Not Walk Independently**

###### Crawls on Four Limbs For 9 Inches or More

1. Place the infant on the abdomen on a carpeted floor or mat. Entice the child forward with a toy or lollipop placed out of reach.
2. Code whether the child moves forward using all four limbs for 9 inches or more (1) or does not crawl (2).
3. Note: Do not credit for crawling if the child uses only upper or only lower limbs.

###### Pulls-to-stand

1. Seat the child on the floor. Offer the child your fingers and raise them if the child actively pulls up. Do not lift the child, simply provide support.
2. Code whether the child actively pulls up to a full standing position (1). Give credit also if the child pulls up holding onto furniture during the examination or rises to a standing position without holding onto furniture or a person.

###### Stands Alone for at Least 3 Seconds

If the child does not stand spontaneously, place the child in a standing position and withdraw support. Time (by counting) whether or not the child stands unsupported for three seconds or more.

###### Stands Alone for at Least 30 Seconds

If child does not stand spontaneously, place the child in standing position and withdraw support. Time (on a stopwatch or by counting) whether or not the child stands unsupported for at least thirty seconds.

#### Takes at Least 3 Steps Supported by Examiner or Caretaker

1. Place the child in a standing position and offer him or her your fingers for support.
2. Encourage the child to walk. Code whether the child takes at least three steps with support (1). Give credit also if the child takes steps without support.

#### Takes at Least 3 Steps Holding Onto Furniture

1. Place the child in a standing position in front of a chair with the child's hands on the edge of the seat.
2. Code whether the child takes at least three steps around the chair (1). Entice the child with a toy or lollipop. Give credit also if the child takes steps without support.

#### Takes at Least 3 Steps Without Support

1. Place the child in a standing position. Entice the child to step forward with a toy or lollipop held out of reach.
2. Give credit also if three or more steps are taken spontaneously.

#### Gets up off Floor to Standing Without Help

Child may start from a supine or a sitting position. Observe whether the child can get up to a standing position without holding onto furniture or a person.

#### Walks Independently for at Least 6 Feet

If necessary, entice the child to walk. Give credit if the child walks without support for a distance of at least six feet.

#### **8.4.4.2 Gait for Children Who Walk Independently**

Position: Walking

State: Awake

1. To encourage walking, have the caretaker stand on one side of the room and place the child on the other side of the room.
2. Ask the child to walk away from you for a distance of at least six feet, turn around, and walk back. Ask the child to walk back and forth again; this time observe the child from the side.
3. Code whether the sign is absent (1) or present (2).

#### Knee Flexion

Knee flexion is present (2) if the child walks with the knees bent forward.

### Knee Hyperextension

Knee hyperextension is present (2) if the child walks with the knees bent backwards.

### Toe Walking

Toe walking is present (2) if the child walks on his/her toes.

### Circumducting Gait

Circumducting gait is present (2) when the leg on one side drags stiffly and swings outward while the child is walking.

### Decreased Arm Swing

Arm swing during walking should be symmetric with both arms traversing the same distance. Code whether either arm has decreased range of swing compared with the other. If both arms traverse the same distance, code decreased arm swing as absent (1) for both.

### Cortical Arm Posture

Cortical arm posture is defined as persistent adduction at the shoulder with flexion at the elbow, with or without forearm pronation.

## **8.4.5 Clinical Neurological Diagnosis**

The examiner should assess the overall tone of the child and summarize his/her clinical impression.

### **8.4.5.1 Tone**

Abnormalities of tone need not be associated with an underlying neurological disease to be coded here.

### Hypotonia

Hypotonia refers to decreased tone evidenced axially by head lag or an inverted U during ventral suspension, or in the limbs as lax joints or excessive range of motion.

1. **Distribution:** If it is the examiner's impression that the child's tone is decreased, record the distribution (general, axial or limb). Code "1" if there is no hypotonia.
2. **Severity:** Grade the severity of the decreased tone (mild, moderate, severe). Code "1" if there is no hypotonia.

### Hypertonia

Hypertonia refers to increased tone as evidenced axially by back arching or retrocollis, or in the limbs by resistance to passive movements and persistent fisting.

1. Distribution: If it is the examiner's impression that the child's tone is increased, record the distribution (general, axial, limb). Code "1" if there is no hypertonia.
2. Severity: Grade the severity at the increased tone (mild, moderate, severe). Code "1" if there is no hypertonia.

#### **8.4.5.2 Diagnosis by Study Examiner**

##### Diagnosis Codes

If the neurological examination is normal, code "1" to indicate no diagnoses are present and leave the diagnostic codes blank.

If the neurological examination is not normal, indicate the appropriate diagnostic code(s). Up to four neurologic diagnoses can be coded.

##### Right/Left/Bilateral/Not Applicable

For each diagnosis, enter which side is involved.

#### **8.5 BAYLEY SCALES OF INFANT DEVELOPMENT**

The neuropsychological test administrator at each Clinical Center will administer the Mental and Motor *Bayley Scales of Infant Development – Second Edition* (BSID-II) at screening, 12 months and 24 months (the end of study treatment). The neuropsychological test administrator must be BABY HUG certified before the BSID-II can be administered (see Section 11.4.4 for certification requirements).

The Medical Coordinating Center will purchase a BSID-II administration kit for each Clinical Center. The kit includes 25 Record Forms for each scale, a BSID-II Manual, all (except two) of the tools necessary to administer the test, and a carrying case. It does not contain a stop watch and a pair of wooden steps needed for administration of the test. Each Clinical Center is responsible for providing these two items. Specifications for the steps are described in Appendix E of the BSID-II Manual. Additional Record Forms will be provided to the Clinical Centers by the MCC as needed.

For Spanish-speaking participants, a translated version of the Bayley is available. To request this material contact Dr. F. Daniel Armstrong at 305-243-6801 at least 2 weeks prior to the examination. His mailing, Federal Express and e-mail addresses can be found on page 31 of the BABY HUG Address Directory. If the Spanish version is used, the administrator must be fluent in Spanish.

Valid and reliable outcomes using the BSID-II require a positive interaction between the examiner and the child, as well as attention to environmental and setting factors that might interfere with acceptable administration. To lessen the risk of outside factors adversely affecting test administration, examiners should include the following considerations related to scheduling:

- Children who are ill (e.g., febrile, in pain) at the time of the scheduled evaluation should be rescheduled.
- The BSID-II evaluation should be scheduled at a time when the child is likely to be alert and interactive. A phone call to the parents prior to scheduling of this examination will assist in determining this time for each individual child.
- The BSID-II evaluation should be scheduled prior to any other BABY HUG study that requires invasive procedures (e.g., blood draws, starting an IV).
- Parents may be present for the examination, but should be provided prior instruction about the nature of the test and what kinds of behaviors they should avoid in order to make the examination fully valid.

The neuropsychologist will administer the Mental and Motor Scales to the child and the Behavior Rating Scale to the child's parent/guardian. The test administrator should strictly adhere to the standardized directions given in the BSID-II Manual for administration of the test. The following instructions should be used to determine the age at which a child is scored.

- If a child is full term (born after 35 weeks gestation), then there is no correction for prematurity for the Bayley. The chronological age (age since birth) is the age to use for all Bayley scoring. For example, if the child was born at 37 weeks, but is 3 months, 0 weeks old (age since birth), then no correction is applied and the age used will be 3 months, 0 weeks.
- If a child is premature (born before 35 weeks gestation), then a correction for the number of weeks premature (based on full term age of 40 weeks) is made when calculating the Bayley scores. For instance, if the child is 34 weeks gestation at birth, then a 6-week correction ( $40-34=6$ ) would be used in calculating the Bayley scores.



- For children who are premature, corrections are applied for months 0-23. After 24 months (chronological age), no correction for pre-maturity is used and all scoring is based on the child's actual chronological age.
- **Exception to #3** - for Extremely Low Birthweight (ELBW) babies (< 1000 grams and <27 weeks gestation), continue correcting through 36 months of age.

To determine the appropriate item set to start with for the testing, round the child's chronological age (or corrected age if premature) to the nearest whole month (i.e., round down if less than or equal to 15 days and round up if greater than 15 days). For example, a 10-month, 17-day old would be rounded up to 11 months and testing would start with the item set designated for an 11-month old. Scoring, however, would be done based on the child's chronological age of 10 months, 17 days.

The actions and responses to the questions are to be recorded and scored on the BSID-II Record Forms by the test administrator, and then transferred to BABY HUG Form 40 (Bayley's) by the test administrator or other neuropsychological staff member. The Index Scores and 95% Confidence Interval for the Mental and Motor Scales, and the Percentile Rank for the Behavior Rating Scale total raw score, must also be recorded on the Record Forms and the BABY HUG form.

Within 24 hours of completion of the BSID-II administration, completed BABY HUG Form 40 is to be given to the institutional Clinic Coordinator for data entry and submission to the Coordinating Center. All original examination forms should be kept in the research files of the study following institutional IRB and HIPAA policies related to storage and maintenance of psychological testing raw data.

If a child's parent/guardian requests the results of the examination, they should be told the following. "This examination is being performed for research purposes. If we observe a severe abnormality that requires immediate attention, we will contact your study doctor for a discussion with you. Under ordinary circumstances in the course of BABY HUG, the results will be used for research purposes only. If you request, this information can be made available to you at the same time information on your child's treatment assignment and study results are provided."

## **8.6 VINELAND ADAPTIVE BEHAVIOR SCALES**

The neuropsychological test administrator at each Clinical Center will administer the *Vineland Adaptive Behavior Scales: Interview Edition* to the child's parent/guardian at screening,

12 months and 24 months (the end of study treatment). The neuropsychological test administrator must be BABY HUG certified before the Vineland can be administered (see Section 11.4.4 for certification requirements).

The Medical Coordinating Center (MCC) will purchase one Vineland Interview Edition (Survey Form) Manual and sufficient Record Booklets for each Clinical Center. The MCC has available two copies (on CD) of the Vineland Learning Laboratory for help with conducting a semi-structured interview. Clinical Centers may borrow the CDs upon request.

For Spanish-speaking participants, a normed and standardized version of the Vineland is available. These materials will be made available to centers requiring their use if requested from the Coordinating Center at least 2 weeks prior to the examination. If the Spanish version is used, the administrator must be fluent in Spanish.

The neuropsychologist will administer the Communications, Daily Living Skills, Socialization and Motor Skills Domains to the child's parent/guardian. The test administrator should strictly adhere to the standardized directions given in the Survey Form Manual for administration of the questionnaire. The responses are to be recorded and scored on the Record Booklet by the test administrator, and then transferred to BABY HUG Form 41 (Vineland) by the test administrator or other neuropsychological staff member. The Standard Score, the 95% Band of Error and the National Percentile Rank must also be recorded on the booklet and the BABY HUG form.

Within 24 hours of completion of the Vineland administration, completed BABY HUG Form 41 is to be given to the institutional Clinic Coordinator for data entry and submission to the Coordinating Center. All original examination forms should be kept in the research files of the study following institutional IRB and HIPAA policies related to storage and maintenance of psychological testing raw data.

If a child's parent/guardian requests the results of the examination, they should be told the following. "This examination is being performed for research purposes. If we observe a severe abnormality that requires immediate attention, we will contact your study doctor for a discussion with you. Under ordinary circumstances in the course of BABY HUG, the results will be used for research purposes only. If you request, this information can be made available to you at the same time information on your child's treatment assignment and study results are provided."

## 8.7 ANTHROPOMETRIC MEASUREMENTS

### 8.7.1 Background

Since BABY HUG is a longitudinal study and growth velocity data will be collected, it is important that all measures be made as accurately as possible. Accuracy and standardized procedures are also necessary in multicenter studies to make sure that data from one center are comparable to data from other centers. In BABY HUG data will be gathered on date of birth, birth weight, and gestational age. Gestational age is estimated from of the number of weeks between the mother's record (recollection) of the onset of her last menstrual period and the child's birth. In clinic anthropometric measures of weight, length, and head circumference will also be taken. Weight should be recorded in grams to the nearest 100 grams (0.1kg). Length and head circumference should be recorded to the nearest 0.1 cm.

### 8.7.2 General Procedures

Anthropometric measurements should be taken by BABY HUG personnel specifically trained and certified to perform these measurements. If possible, the same examiner(s) should measure participants throughout the study period. Whenever possible, measurements should be taken by a team of two observers. One observer takes the measurements while the other observer records. The observer taking the measurements calls out the results to the recorder. The recorder repeats the results and then calls out the name of the next measurement. The observer keeps the measuring instrument in place until the recorder repeats the number. The recorder checks the examinee's position during the procedure. All of the measurements – weight, length, and head circumference – are made once before repeating them a second time in the same sequence by the same observer. A third measurement is made by the same observer only if the second measurement differs from the first by the following amount:

<u>Measurement</u>	<u>Difference between 1<sup>st</sup> two measurements</u>
weight	0.2 kg
length	0.5 cm
head circumference	0.4 cm

It is important that the measurements be made in pleasant, warm, and quiet surroundings. If blood specimens are taken, they should be drawn after anthropometric data have been obtained. Each center will use the same apparatus for all measurements.

### **8.7.2.1 Weight**

The weight measurement is critical to assessing growth velocity. Thus, weight must be measured accurately. Following is a description of instruments and methods used for weighing infants.

#### Materials and Methods

- A scale accurate to  $\pm 10$  grams is desirable. It may be a beam balance or a modern electronic recording balance.
- The balance should be checked for accuracy just prior to use by adjustment of zero weight on the balance beam and weekly by verifying standard (National Bureau of Standards - NBS) weights of 2 and 4 kg. At least yearly, the balance should be inspected and adjusted if necessary by a qualified representative of the manufacturer.
- The child is weighed nude. If a pan balance is used it may be uncomfortable; a pad can be placed on the pan. The pad is weighed, and this weight is recorded and subtracted from the total weight (infant + pad). Alternatively, the balance is adjusted to zero with the pad in place. Whichever procedure is used, it should be practiced consistently throughout the study.

A less preferable option is to weigh the child with a dry diaper or undershirt. If this option is chosen, the child must consistently be weighed this way, including consistently subtracting the weight of the clothing from the measured weight or zeroing out the balance.

- The child must be relatively quiet and still during the weighing.
- The child is weighed to at least the nearest 100 grams (0.1kg).
- The first weight is recorded on the BABY HUG study form. The child is then weighed again, and this measurement is also recorded. If the two measurements do not agree within 200 (0.2kg) grams, a third weighing should be made. Individuals

making the weighings should sign the data form and record their certification numbers.

### **8.7.2.2 Length**

Linear growth of children is assessed by measuring length. Recumbent length should be used up to 18 months of age and standing height after 18 months of age. If the child will not stand after 18 months of age, recumbent length should be measured and noted in the comments section of the form. Of the anthropometric data, recumbent length may be the most difficult to obtain accurately. Examiners should practice measuring infants and verify their ability to measure recumbent length accurately.

#### Materials and Methods

- A recumbent length measuring board with fixed headboard and movable footboard that are perpendicular to a table surface is required. The measuring scale must be along the circumference of the board. The scale should be in centimeters with 0.1 cm divisions.
- The board should be regularly checked that the scale is in place and that the footboard is functioning properly with minimum play around a horizontal or vertical axis.
- Two measurers are needed to obtain satisfactory measurements. One measurer holds the child's head in a plane that allows the child to look upward in a line joining the left tragus and the lowest point of the inferior margin of the left orbit: line of sight (13). Slight traction is applied to bring the top of the child's head to the headboard. The other measurer holds the child's feet with toes pointed upward and brings the footboard gently against the infant's feet. Press knees to straighten legs, i.e., they should be fully extended to avoid under-estimating length. Once the child is in place, the measurer holding the head may observe that the head is no longer touching the headboard. The footboard should not be brought forward. Instead, the head should be brought gently but firmly back to the headboard. This is appropriate, because the child should be stretched slightly to give an accurate measurement (see illustration).

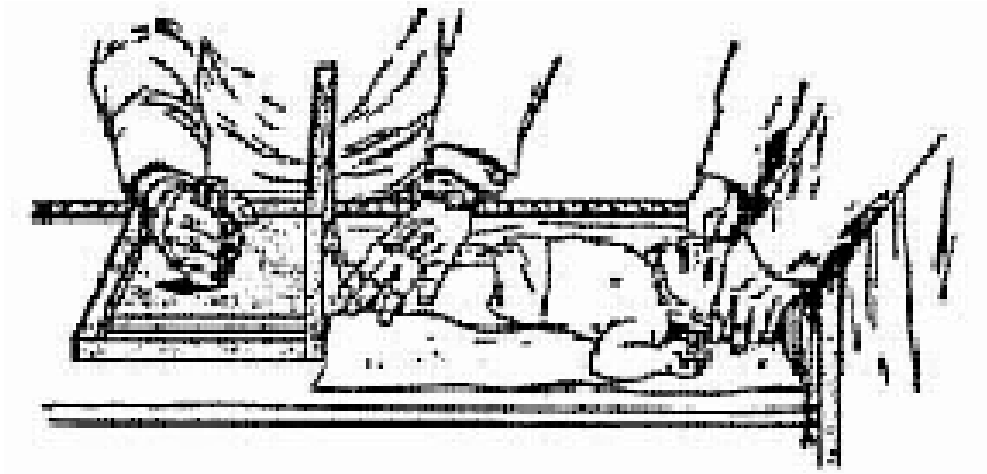

- The child's recumbent length is measured to the nearest 0.1 cm.
- The recumbent length measurement in cm and the data are recorded on the study form.



From Pediatric Anthropometry.  
W Moore and A Roche, 1987

- The measurement should be repeated and value recorded. If the two measurements do not agree within 0.5 cm, the recumbent length should be measured a third time. The two measurers may change positions for the third measurement.
- If the child has a “corn row” hairstyle, the best possible recumbent length measures should be taken and the presence of “corn rows” should be noted on the study form.

### **8.7.2.3 Head Circumference**

#### Materials and Methods

- Head circumference is measured with a flexible narrow non-stretchable tape. Steel and fiberglass tapes are satisfactory. Disposable paper tapes can also be used.

- If the same tape is used repeatedly, it should be checked periodically against a steel centimeter reference tape.
- Head circumferences are measured in young children while lying still. In measuring the older child, it is preferable for the child to be on the mother's lap.
- The tape is placed firmly around the head above the supraorbital ridges (right above the brows). While holding the tape in place with the index or middle finger of one hand, the tape is passed over the occipital prominence (bump) at the back of the head with the other hand and the maximum circumference is noted.
- The tape should be pulled snugly around the head compressing the hair (see illustration). The tape must be kept in the same plane on left and right sides of the head. The measurement should be recorded to the nearest 0.1 cm.
- The measurement should be repeated and value recorded. If the two measurements do not agree within 0.4 cm, the head circumference should be measured a third time. The two measurers may change positions for the third measurement. All measures should be recorded on the BABY HUG study form.
- If the child has a "corn row" hairstyle, the best possible circumference measures should be taken and the presence of "corn rows" should be noted on the study form.

#### **8.7.2.4 Training and Certification**

Problems with different observers over time occur and thus it is important to keep the number of observers to a minimum and ensure continued training and certification over time. Inter-observer variability and errors related to lack of skills can introduce major errors in the data. A goal will be to have an individual certified as a trainer at each Clinical Center so that individuals subsequently joining the staff can be trained on site, certified, and recertified. Training and certification will be on site at all BABY HUG Clinical Centers and carried out by the master trainer.

The certification procedures trains the measurers at each site in the techniques and process of taking the actual measurements covered in this manual. During this procedure recording methods, equipment calibration and potential sources of error will be demonstrated.

Recertification will be required every year after the original certification. This will be carried out by each center's designated trainer or by the Study's master trainer. The designated trainer

will be certified as having demonstrable measurement skills and knowledge of the methodology, including recording, for avoidance of errors.

## 8.8 URINE CONCENTRATING ABILITY

Infants with sickle cell disease lose ability to concentrate urine (even when fluid deprived) very early in life. We want to know if hydroxyurea treatment will delay or prevent this problem. For the urine concentrating ability study, the goal is to obtain a urine specimen produced after at least four hours and no more than ten hours after the infant is made NPO. The longer duration of NPO within this range, the better!

**Important:** Length of NPO status must be recorded on the BABY HUG study form. Thus, time of last po intake and times of first and second voids must be noted.

1. Parents should be provided with the following:
  - 5 urine bags
  - 2 urine cups
  - cleaning pads
  - Benzoin swabs
  - 2 biohazard bags
  - 2 labels to record date and time of voids (**not** BABY HUG study labels)
  - 2 copies of the *Instructions and Worksheet for Parents* (see Exhibit 8-2)
2. Review with the parents the *Instructions and Worksheet for Parents*.
3. Have parents note and record date/time of last po intake on their Worksheet. This should be at approximately 2 am. They should have the child void if toilet-trained.
4. Have parents place the bag on the child at or after 6 am. They should note whether or not the diaper is wet. Instruct the parents as to proper placement of bag.

### PROPER BAG PLACEMENT

- i. Clean diaper area well and dry completely.
- ii. Have one person hold legs in “open frog position.”
- iii. Apply Benzoin if desired.
- iv. Apply bag. Tuck under baby’s bottom and put diaper on snugly.
- v. Check bag frequently and remove if there is urine.



- vi. Put bag with urine in urine cup #1. If child has a bowel movement, try to put the urine into the bag without getting any stool in the specimen. If there is stool in the urine, clean and try again.
  - vii. Repeat steps i-vi for the second bag specimen.
5. If the child is toilet-trained, s/he should urinate into cup #1 at least 4 hours after NPO, record time, then wait for the next void for cup #2 (record time).
6. Retrieve the Worksheet and all specimens when the parents and child arrive for the BABY HUG clinic visit.
7. If a second specimen is obtained, transfer the urine to the provided plastic vial (at least 0.1 ml is required), and affix a unique 5-digit BABY HUG label to the vial and a duplicate label to the study form. Record length of NPO status. If no urine is collected in the second bag or a toilet-trained child does not void into cup #2, use the first urine collection as the urine concentrating ability specimen.
8. Obtain a blood specimen for serum osmolality as close to the second collected void as possible. Affix a unique 5-digit BABY HUG label (not the same label number as used for the urine specimen) to the tube and a duplicate label on the study form next to 'Biochemistry specimen'. No IV fluids should be given until the second post-NPO urine and serum are obtained UNLESS  
Child/parents very irritable  
Total duration NPO  $\geq$  10 hr  
Any fluid intake prior to these specimens, whether po or IV, must be noted. Data may not be useable if volumes of intakes are substantial.
9. Fill out Transmittal Form 102. Record both the urine specimen and biochemistry specimen label numbers on the transmittal form. In the appropriate column next to the label numbers, enter a "1" to indicate to the laboratory that a urine or serum osmolality test must be performed.
10. Ship both the urine specimen and biochemistry specimen the day of collection to the Biochemistry Core Laboratory. See Section 7.4.4 for shipping procedures to the Biochemistry Core Laboratory.

## **8.9 URINALYSIS**

Urine collected for urinalysis should be collected on the same day that the urine is collected for the urine concentrating ability assessment. A freshly voided specimen should be used, preferably the first specimen available to the Clinical Center. Urine contaminated with fecal material should be discarded and a repeat specimen obtained. Urine must arrive at the laboratory and be analyzed within two hours of collection. If this cannot be assured routinely, the specimen should be hand-delivered to the laboratory and/or ordered "STAT." Urine should not be refrigerated prior to analysis.

Urinalysis should be performed in a local laboratory certified by the College of American Pathologists which uses appropriate reagent strips (e.g., Bayer Multistix 10SG Reagent Strips or similar). A microscopic analysis must be ordered; an estimate of the number of cells using a dipstick is not satisfactory. Microscopic analysis should be performed by a certified technician.

A normal number of red and white cells in most laboratories is less than 3-4 and normal reports should be indicated on BABY HUG Forms 5 (Part IV Item 2) and 36 (Part IV Item 2). If your laboratory reports "more than 30" or "more than 50" rather than "more than 20," the "more than 20" box may be checked.

## **8.10 O<sub>2</sub> SATURATION**

With the invention of pulse oximetry, it has become possible to monitor arterial saturation on a beat-to-beat basis. It has proven to be a safe, noninvasive, and accurate way to measure oxygen saturation.

Pulse oximeter readings will be performed with a Nellcor Oxisensor transducer with a Datascope Passport monitor (model EL, Montvale, NJ) or similarly validated equipment. Measurements will be obtained at screening and every three months after treatment initiation. Two measurements are required at each time point.

The instrument transmits two wave-lengths of light through a vascular bed and measures the differential absorption of the light by oxyhemoglobin and deoxyhemoglobin. The analyzer then calculates the ratio of pulsatile vs. baseline absorption. Oxygen saturation (O<sub>2</sub> saturation) is then calculated from this ratio and recorded as a percentage to the nearest percent.

## **8.11 TRANSCRANIAL DOPPLER ULTRASOUND**

### **8.11.1 Background**

Transcranial Doppler (TCD) ultrasound has proven very useful in estimating stroke risk at the point of primary prevention. It is at the center of a paradigm of primary prevention in children with sickle cell disease (SCD), as recommended by NHLBI/NIH, based on the Stroke Prevention Trial in Sickle Cell Anemia (STOP), a randomized clinical trial.

TCD ultrasound is a secondary endpoint in the BABY HUG study. In an effort to investigate the effect of hydroxyurea (HU) on the central nervous system in the BABY HUG study, TCD data will be collected on cerebral blood flow (CBF) velocity and measured as cm/sec. TCD is a non-invasive exam that is painless and does not require patient sedation. The patient is placed in a supine position and a 2mhz probe is placed along the transtemporal region of the head. The average length of the TCD ultrasound is approximately 30-60 minutes, depending on the cooperativeness of the patient.

The TCD ultrasound will be performed during screening (baseline), 12 months and 24 months (the end of study treatment). The baseline TCD ultrasound will be captured within a window of 8 weeks prior to randomization (up to and including the day before randomization).

### **8.11.2 Consent for TCD**

Consent to perform the TCD ultrasound is included as part of the BABY HUG consent.

### **8.11.3 Arranging a TCD Visit**

The TCD can be performed by either a Medical College of Georgia (MCG) traveling TCD examiner or a local examiner certified by MCG. If the TCD ultrasound will be performed by the traveling TCD examiners from MCG, the TCD Coordination Center will need at least 5 working days advance notice to arrange for the TCD visit to the BABY HUG Clinical Center.

The BABY HUG coordinator will need to confirm a date with the parent and the TCD coordinating center. It would be very helpful if the BABY HUG coordinator placed a reminder call to the parent the day before the scheduled TCD visit. The BABY HUG coordinator will also need to provide the TCD examiner with the appointment time and location for the TCD ultrasound.

The BABY HUG coordinator should reserve a quiet room with an exam table for at least an hour or two for the TCD ultrasound. The assistance of the BABY HUG coordinator will be needed

to ensure the best quality TCD ultrasound; therefore, the coordinator should plan to stay in the room with the patient until the TCD exam has been completed.

The TCD examiner will bring the TCD equipment to the BABY HUG Clinical Center on the day of the TCD visit. If a Clinical Center’s institution requires inspection of the TCD equipment by Biomedical Engineering, then a time should be arranged prior to the TCD examiner arriving at the site.

On the day of the TCD visit, the TCD examiner will need to be supplied with a box of Kleenex, a rollable/adjustable chair, and a sheet for covering the patient if needed.

#### 8.11.4 Eligibility Based on TCD

In order for a child to be eligible for BABY HUG, a TCD must be attempted. If the child and the TCD examiner are together in the same room with the examiner ready to proceed, the TCD is defined as “Attempted”. Figure 8-1 illustrates the sequence of TCD results that determine whether the child is eligible once the TCD is attempted.

#### 8.11.5 BABY HUG TCD Study Form

If a TCD was attempted, BABY HUG Form 46 (TCD Performance) will be completed by the BABY HUG coordinator and TCD examiner to document the performance of the exam. The BABY HUG coordinator will affix one of the patient’s 5-digit label numbers to the form. The TCD exam form will remain with the BABY HUG coordinator at the BABY HUG Clinical Center.

**FIGURE 8-1**

**TCD Eligibility Criteria For Randomization**

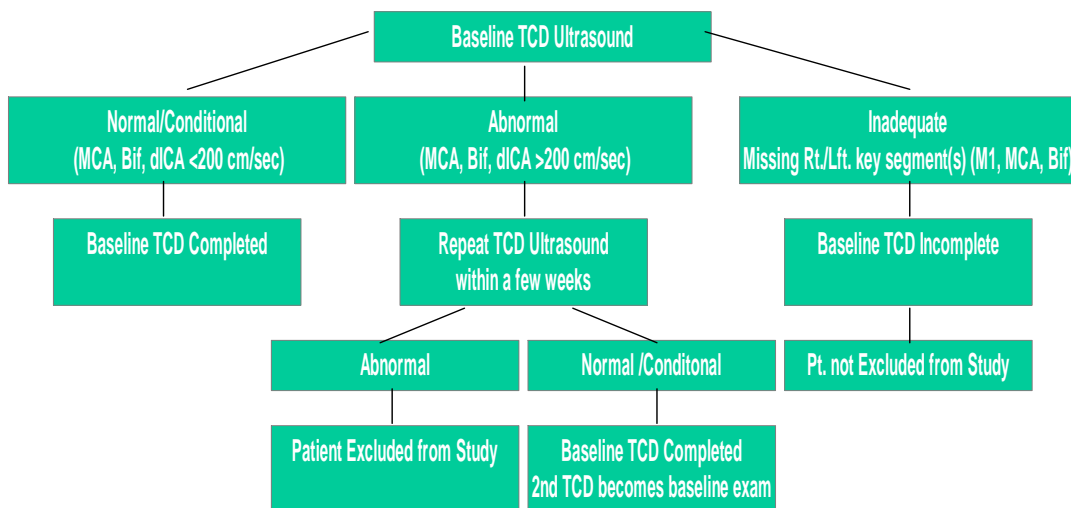

## **8.11.6 Transcranial Doppler Scanning Protocol**

### **8.11.6.1 Prior To Recording**

1. The TCD examiner should view the signed copy of the informed consent to verify that the parent has given consent for the patient to have the TCD ultrasound. The examiner should also verify that the consent matches the BABY HUG Patient ID Number.
2. Obtain the patient's TCD exam form (Form 46) from the BABY HUG study coordinator. A 5-digit label number should be affixed to the form.
3. Turn on the TCD machine. The TCD machine should boot up to a blue colored main menu screen. Select "On-line Diagnostic", then press "enter" twice.
4. Type the patient's BABY HUG 5-digit label number (the same number that is on the child's Form 46) into the patient field box labeled "ID/Filename". Press the enter key.
5. Enter the Study Type as "BABY HUG" press "enter" three times.
6. Measure the patient's transtemporal head diameter using the calipers that have provided for you and record patient's transtemporal head diameter in the patient information field labeled " Head diameter".
7. Press the enter key, until the computer indicates that the TCD program is on-line.
8. The TCD examiner presses the "probe" key on the control keypad until coming to the BABY HUG approach default settings. Make sure the sample volume is defaulted to 4mm.
9. The computer should default to the left or right side BABY HUG approach.
10. The TCD examiner makes certain the TCD display defaults to the correct side being insonated (e.g., TMPORL R (right side) or TMPORL L (left side)).

### **8.11.6.2 Recording the Arterial Vessel Segments**

#### Insonating the MCA

1. Starting at the initial depth of 50 mm, the probe is usually aimed slightly anteriorly and superiorly to identify the MCA. Once the signal has been obtained, the examiner must verify that the artery is the MCA. This is done by tracking the vessel to the shallowest depth at which an adequate signal can be identified. In this very young

age group, the M1 should be approximately 32-34 mm and should never exceed a depth of 40 mm.

2. Increase the depth of insonation by 2mm, and optimize the signal obtained. Record this depth as MCA. Continue to increase the depth by 2mm increments, obtain a signal, optimize, and label the recording at 2mm intervals, tracking the MCA, moving from M1 towards the Bif.

Then proceed to insonate the Bif

3. The Bif is identified as a bi-directional signal, with flow towards the probe representing the MCA, and flow away from the probe representing ACA. The TCD examiner obtains a signal that is optimally equal in “intensity” above and below the line. Record this as the Bif.

Then proceed to insonate the ACA

4. From the ICA bifurcation, the examiner will increase the depth of insonation by 4 mm, and should change the directional arrow to indicate flow away from the probe.
5. At this depth, the ACA should lie slightly anteriorly and superiorly to the ICA bifurcation. Angle the probe to obtain the ACA signal. Usually at this depth the ACA may be recorded to isolate (no other signals detected). If flow towards the probe is still detected, the TCD examiner should verify that the bi-directional flow thought to be the ICA bifurcation is in fact the bifurcation of the ICA, and not a branch of the MCA. If the depths are appropriate, this may be recorded as the ACA. Optimize the signal, and record the highest velocity. If necessary the depth may be increased 2 mm more to further optimize the signal. Record the highest velocity optimized ACA signal.

Next Insonate the dICA

6. After obtaining the ACA recording, the TCD examiner decreases the depth of insonation to return to the Bif. Change flow direction so that the arrow indicates flow toward the transducer.

Angle the probe 10-20 inferiorly and increase depth 4mm to isolate and record the optimal dICA. If necessary the depth may be increased 2 mm further to optimize the signal.

### Next Insonate the PCA

7. After obtaining the dICA signal, the TCD examiner decreases the depth of insonation to return to the level of the Bif. Once this has been clearly re-identified, the transducer should be angled posteriorly 10-20 to identify the PCA. The PCA may lie at the same level as the Bif, or may be slightly inferior to it. Make sure that the waveform identified does not have a velocity of less than half the MCA. If it does, this probably represents the superior cerebellar (SCA). The SCA is slightly inferior to the PCA.
8. The TCD examiner records the PCA at its shallowest depth (4mm from the depth of the Bif). Then increase the depth by 2mm increments, optimize the signal and record the PCA. Continue to increase the depth by 2mm increments, optimize the signal, and record the waveform as PCA. Bi-directional flow should be identified as the midline. This represents the top of the Basilar (TOB). Optimize this signal and record.

### Repeat

9. The TCD examiner will need to follow the TCD scanning protocol (steps 1-8) for the opposite side of the head.

### **8.11.6.3 Transferring the TCD Study From the Nicolet Companion**

After the study has been completed, the TCD examiner will need to exit the on-line diagnostic mode.

1. Press escape. The prompt "Exiting On-line?" will appear on the screen; choose "y".
2. The TCD examiner selects "file management" and presses "enter". Then choose "backup copy" and press "enter".
3. The TCD examiner selects the storage disk media to copy the study onto: "floppy disk" or "zip drive", and presses enter. Highlight the study to be copied in the file list. Place a right arrow by the study by using the "right arrow" key on the control pad and press enter.
4. Once the study(s) has copied 100%, the TCD examiner will need to verify that the study was copied onto the diskette. Press "escape" twice; this will bring back the file management screen.

5. The TCD examiner selects “restore copy” and press “enter”. Choose the disk storage media the study was copied onto: “floppy disk” or “zip disk” and press “enter”.
6. In the File list, the TCD examiner should see the study that was copied appear. If the study is not listed, the TCD examiner will need to press “escape” and recopy the study using steps (3-6).

#### **8.11.7 Processing TCD EXAM and Result Notification**

The TCD examiner will copy the study prior to leaving the BABY HUG Clinical Center (see section 8.11.6.3). A backup copy of the TCD diskette will be left at the BABY HUG Clinical Center. The BABY HUG coordinator should affix a duplicate label (i.e., with the same 5-digit number that is affixed on the child’s Form 46; see Section 8.11.5) to the TCD diskette. The study will be read and interpreted by the TCD Center at the Medical College of Georgia. The TCD ultrasound results will be sent to the Medical Coordinating Center (MCC). The MCC will post whether the TCD ultrasound results are normal on the Eligibility Status Report for the patient.

#### **8.11.8 TCD Certification for BABY HUG Clinical Center Examiners**

1. Each BABY HUG Clinical Center may identify a person on site who will be trained to perform the TCD exams. The TCD Center at the Medical College of Georgia will need this person’s contact information (phone/pager/cell numbers and department/address at the Clinical Center’s institution), curriculum vitae and human assurance credentials.
2. MCG will need to know if each Clinical Center has a TCD machine, and if so, the type of TCD machine. The Nicolet Companion will be used to examine the BABY HUG patients. All other TCD machines must be compatible with the Nicolet Companion. This must be verified with MCG.
3. MCG will send the TCD Examiner trainee:
  - A. A copy of the TCD scanning protocol that will be used for the BABY HUG study.
  - B. A pair of calipers that will be used to measure the patient’s transtemporal head diameter, if the BABY HUG Clinical Center does not currently have a pair.



- C. A memo containing information on how to set the TCD machine defaults for BABY HUG exams.
  - D. An English.trn diskette with written instructions for loading. This English.trn file will update the **patient information screen** on the Companion, so that any labeled "STOP2" fields will be replaced with a field labeled "Study Type". This will allow the examiner to type in whether the study will be a STOP2 or a BABY HUG study.
4. MCG will ask that 3 high quality (follows BABY HUG TCD scanning protocol), practice TCD exams be sent in for review. Practice exams can be performed on patients with any Hb S syndrome, and this includes Hb beta-plus thalassemia (Hb SB+thal) and Hb SC.
  5. MCG will provide the TCD examiner trainee with a FEDEX account number and the TCD address so they can send the practice exams to Dr. Adams for review. The TCD training examiner is encouraged to send TCD exams in a very timely manner, so that they can be provided with feedback on their TCD scanning performance.
  6. When the MCG traveling TCD examiners are at a BABY HUG Clinical Center for a TCD visit, they will also provide hands-on training with the TCD training examiners, as time allows.
  7. If MCG feels that a TCD examiner trainee is performing high quality exams, the trainee may be asked to perform 2 more exams while being observed by the MCG TCD examiner prior to performing solo BABY HUG TCD(s).
  8. Upon satisfactory TCD scanning performance and review of 3-5 high quality TCD exams, the TCD examiner trainee will be certified to independently perform the BABY HUG TCD exams at their site.

**EXHIBIT 8-1**

**RENAL GFR/DTPA CLEARANCE WORKSHEET**

Patient ID: \_\_\_ - \_\_\_

Date: \_\_\_ / \_\_\_ / \_\_\_

Height: \_\_\_\_\_ cm

Weight: \_\_\_\_\_ kg

**Standard Dilution Volume**    500 ml

**Standard Syringe Activity**

Pre: \_\_\_\_\_ D.F. \_\_\_\_\_ X (%) = \_\_\_\_\_  $\mu$ Ci    Time: \_\_\_ : \_\_\_

Post: \_\_\_\_\_ D.F. \_\_\_\_\_ X (%) = \_\_\_\_\_  $\mu$ Ci    Time: \_\_\_ : \_\_\_

**Dose Syringe Activity**

Pre: \_\_\_\_\_ D.F. \_\_\_\_\_ X (%) = \_\_\_\_\_  $\mu$ Ci    Time: \_\_\_ : \_\_\_

Post: \_\_\_\_\_ D.F. \_\_\_\_\_ X (%) = \_\_\_\_\_  $\mu$ Ci    Time: \_\_\_ : \_\_\_

**Time Dose Injected:**    \_\_\_ : \_\_\_

**Blood Samples Post Injection**

1 hour: \_\_\_\_\_ ml blood drawn    Time drawn \_\_\_ : \_\_\_

2 hour: \_\_\_\_\_ ml blood drawn    Time drawn \_\_\_ : \_\_\_

4 hour: \_\_\_\_\_ ml blood drawn    Time drawn \_\_\_ : \_\_\_

**Counts**

Room (water) background:    Tube 1: \_\_\_\_\_ cpm    Tube 2: \_\_\_\_\_ cpm

Standard:    Tube 1: \_\_\_\_\_ cpm    Tube 2: \_\_\_\_\_ cpm

Plasma (1 hour):    Tube 1: \_\_\_\_\_ cpm    Tube 2: \_\_\_\_\_ cpm

Plasma (2 hour):    Tube 1: \_\_\_\_\_ cpm    Tube 2: \_\_\_\_\_ cpm

Plasma (4 hour):    Tube 1: \_\_\_\_\_ cpm    Tube 2: \_\_\_\_\_ cpm

**GFR**

\_\_\_\_\_ ml/min    \_\_\_\_\_ ml/min/m<sup>2</sup>    \_\_\_\_\_ ml/min/1.73m<sup>2</sup>

## EXHIBIT 8-2

### Urine Concentrating Ability Instructions and Worksheet for Parents

Use the worksheet below to record the information requested in the following instructions.

1. Note and record the date and time of the last food or fluid taken by mouth before starting the study. This should be at approximately 2 am.
2. After at least 4 hours, have your child urinate in cup #1 if toilet-trained and save the urine. Otherwise, place a bag over the genitals as instructed. Be sure the bag is sealed well.  
**PROPER BAG PLACEMENT**
  - i. Clean diaper area well and dry completely.
  - ii. Have one person hold legs in "open frog position."
  - iii. Apply benzoin if desired.
  - iv. Apply bag. Tuck under baby's bottom and put diaper on snugly.
  - v. Check bag frequently and remove if there is urine.
  - vi. Put bag with urine in urine cup #1. If child has a bowel movement, try to put the urine into the bag without getting any stool in the specimen. If there is stool in the urine, clean and try again.
  - vii. Repeat steps i-vi for the second bag specimen.
3. Save the first urine made after at least 4 hours without fluid or food, then the second. Label both specimens with date and time. Give all specimens to the doctor or nurse when you see them.
4. **DO NOT GIVE YOUR CHILD ANYTHING TO EAT OR DRINK.** If he or she is so cranky or complaining that you have to give something, give as little as possible and write down the time and how many ounces you give.
5. A blood specimen needs to be obtained as close as possible to the second collected void. Be sure the doctor and study coordinator know you have been doing this test so they will take the blood. If your child needs an IV, they can do that with the same stick. Also let the doctor or coordinator know if it has been more than 10 hours since your child had anything to eat or drink.

### THANK YOU!

Time of last fluid: \_\_\_\_\_ am pm

Time of first urine collection: \_\_\_\_\_ am pm

Was your child's diaper wet when the first urine bag was placed? Yes No

Time at second urine collection: \_\_\_\_\_ am pm

Problems: \_\_\_\_\_  
\_\_\_\_\_

Fluid intake (TO BE AVOIDED!): \_\_\_\_\_ oz at \_\_\_\_\_ am pm

**PEDIATRIC HYDROXYUREA PHASE III CLINICAL TRIAL (BABY HUG)  
MANUAL OF OPERATIONS**

**CHAPTER 9**

**READING GROUPS**

**9.1 INTRODUCTION**

All imaging special studies and event reports will be centrally evaluated by individuals blind to treatment assignment and independent of the BABY HUG Clinical Centers. This includes liver/spleen scans, abdominal ultrasounds and clinical events. The Clinical Centers will send the films to the Medical Coordinating Center (MCC), and MCC staff will forward them to the central readers.

**9.2 LIVER-SPLEEN SCAN**

**9.2.1 Overview**

The liver spleen scans will be read by two nuclear medicine specialists who will independently assess each pre-enrollment (baseline) and 2-year scan as having normal, decreased or absent spleen function. In case of disagreement, a scan will be sent to a third reviewer. The two readings out of the three that are in agreement will be the single final reading. This qualitative assessment of spleen function will be used for determining the primary endpoint outcome: worsened or not worsened (includes improved) spleen function.

**9.2.2 Scans Required for Central Reading**

Scans will meet the following specifications.

400K Image

- Proper identification (Patient 5-digit label number and date)
- An anterior view labeled #1
- A posterior view labeled #2
- An anterior view with region of interest around spleen and liver with counts and counts/pixel recorded on film labeled #3
- A posterior view with region of interest around spleen and liver with counts and counts/pixel recorded on film labeled #4

- The geometric mean counts and the geometric mean counts/pixel of spleen and liver from both views calculated and recorded on film labeled #5
- The total and counts/pixel spleen to liver ratios recorded on film labeled #6

#### Timed Image

- Proper identification (Patient 5-digit label number and date)
- A left anterior oblique (LAO) view labeled #7
- A right posterior oblique (RPO) view labeled #8
- A LAO view with region of interest around spleen and liver with counts and counts/pixel recorded on film labeled #9
- A RPO view with region of interest around spleen and liver with counts and counts/pixel recorded on film labeled #10
- The geometric mean counts and geometric mean counts/pixel of spleen and liver from both views calculated and recorded on film labeled #11
- The total and counts/pixel spleen to liver ratios recorded on film labeled #12

#### **9.2.3 MCC Scan Processing Procedure**

Clinical Center staff will forward one copy of each film to the Medical Coordinating Center (MCC) with a transmittal form (BABY HUG Form 111). The MCC will log receipt of the films, and forward them to one of the reviewers with a blank Liver-Spleen Scan Central Reading Form (Form 84). The grader will complete the Form 84 and return the films and the form to the MCC. The MCC will then forward the films to the other reviewer with a blank Form 84; the second grader will complete the Form 84 and return the films and the form to the MCC. MCC coordination staff will data enter the forms. MCC computing staff will compare the two gradings. If they agree, the spleen reading is final. If they disagree, the scan will be sent to a third reviewer. On receipt of the third reading, a single final reading will be the two readings that agree. At the end of the study, the spleen primary outcome (improved, not worse or worse) will be computed by MCC statistical staff at the time of interim and the final data analysis.

If a reader determines that the scans are not of sufficient quality to be evaluated (Form 84, Part II, Item 3: Current status of this reading), the scans are returned to the MCC with an explanation and a recommendation (Form 80 is required from the reader) for the Clinical Center. If a liver-spleen scan as submitted is judged to be inadequate for reading, it will be returned to the

Clinical Center for reprocessing if possible. If reprocessing is not possible, a repeat scan will not be performed (unless IRB approval is obtained) and no final grading will be available. If an inadequate scan is a pre-enrollment (baseline) scan, that child is ineligible for BABY HUG enrollment.

#### 9.2.4. Guidelines for Qualitative Grading of Liver-Spleen Scans

The central readings will be based on qualitative, visual assessments comparing uptake in the spleen to that in the liver. The reader will rate the spleen uptake on the posterior and LAO views, as compared to uptake in the left lobe of the liver and provide a qualitative assessment of spleen function. The measurement will be recorded on Form 84 (Liver-Spleen Scan Central Reading) as follows:

- *Normal*: normal spleen function (uptake proportionate to liver);
- *Decreased*: spleen function but decreased (uptake disproportionately lower than liver);
- *Absent*: spleen function absent (no appreciable uptake above background level.

#### 9.2.5 Liver-Spleen Primary Outcome

The readings as applied in Table 9-1 determine for each child whether spleen function has improved, worsened or not worsened in two years of randomized therapy. These three categories (Improved, Not Worse, and Worse) contribute to the possible responses for the spleen primary outcome.

TABLE 9-1  
Liver-Spleen Primary Outcome Determination

Spleen Function at Baseline	Spleen Function After Two Years of Study Medication		
	<i>Normal</i>	<i>Decreased</i>	<i>Absent</i>
<i>Normal</i>	<b>Not worse</b>	<b>Worse</b>	<b>Worse</b>
<i>Decreased</i>	<b>Improved</b>	<b>Not Worse</b>	<b>Worse</b>
<i>Absent</i>	<b>Improved</b>	<b>Improved</b>	<b>Not Worse</b>

#### 9.2.6 Guidelines for Quantitative Grading of Liver-Spleen Scans

A quantitative assessment of liver-spleen uptake will provide additional information about spleen function that may be used as a secondary endpoint in the data analysis. The total count spleen-liver geometric means and ratio will be recorded on the films for both the 400 K Image and

Timed Image. The counts/pixel spleen-liver geometric means and ratios (400K Image and Timed Image) will also be calculated. A spleen-liver ratio greater than 0.2 using total counts is often considered normal, while below 0.2 is often considered reduced splenic function. Using counts/pixel, a spleen-liver ratio in the 0.7-0.9 range is considered normal.

**9.3 ABDOMINAL ULTRASOUND**

**9.3.1 Overview**

Abdominal ultrasound imaging will be performed during pre-enrollment (baseline) and exit (end of study treatment). The evaluations are tailored specifically to determine splenic volume and echogenicity, renal volumes and echogenicity and to assess the gallbladder and biliary system. The imaging will be centrally reviewed by one pediatric radiologist.

**9.3.2 Assessment of the Spleen**

**9.3.2.1 Splenic Parenchyma**

Representative images of the entire spleen will be obtained in the longitudinal and transverse planes and the parenchyma will be assessed for normal vs abnormal echogenicity.

**9.3.2.2 Splenic Volume**

Table 9-2 shows normal values to use to evaluate splenic volume [1].

TABLE 9-2  
Splenic Volume

Body length	Splenic Volume Mean values	Standard deviation
56 - 70 cm	18.02 cc	7.54
71 - 85 cm	29.63 cc	14.48
86 -100 cm	32.53 cc	16.09

**9.3.3 Assessment of the Kidneys**

**9.3.3.1 Renal Parenchyma**

Representative images of both kidneys will be obtained in the longitudinal and transverse planes and the cortical echogenicity will be determined to be either normal or abnormal.

### 9.3.3.2 Renal Volume

Figure 9-3 will be used as standards to evaluate the renal volumes [2].

Figure 9-3  
Kidney Volume

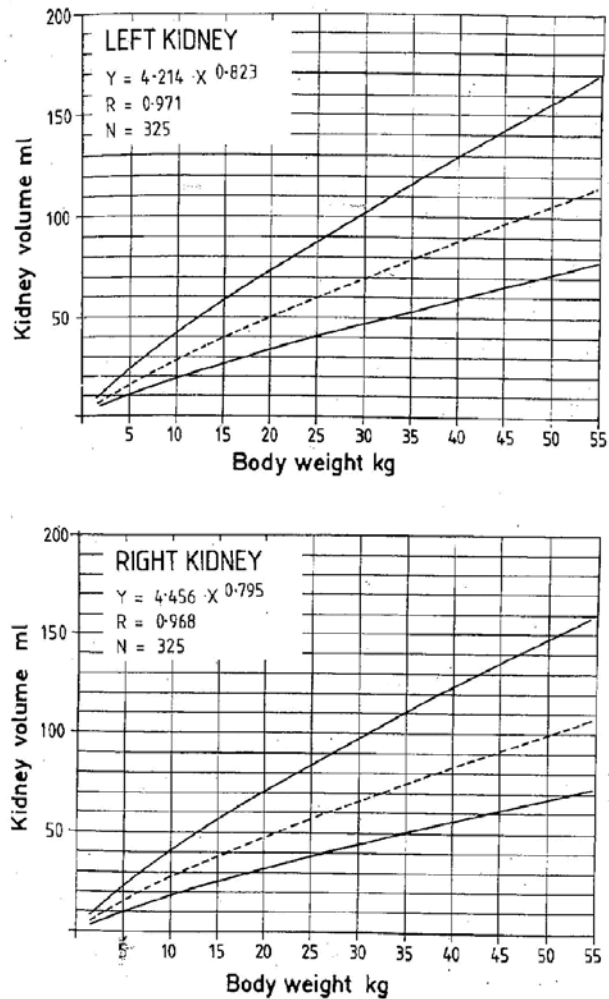

### 9.3.4 Gall Bladder and Biliary System

The gall bladder wall will be considered abnormally thickened when it measures > 3 mm. The common bile duct will be considered to be dilated when it measures > 2 mm in patients up to 12 months of age and > 4 mm in patients older than 12 months [ 3,4].



### **9.3.5 Liver**

There are no published normal liver lengths or volumes for children. For purposes of determining whether the liver is enlarged we will use a comparison of the liver length with the length of the right kidney. If the inferior tip of the liver extends below the inferior tip of the right kidney on a longitudinal image obtained in the region of the right kidney with the longest dimension, we will consider the patient to have hepatomegaly.

### **9.3.6 Processing Scans for Central Reading**

The ultrasound images will contain the following information

- Proper identification (Patient 5-digit label number and date)
- The probe frequency
- Annotate the image with the position of the patient if other than supine/recumbent
- Annotate the image as transverse or longitudinal
- Measurements of the spleen in the transverse, anterior-posterior and longitudinal dimensions
- Measurements of the kidneys in the longitudinal, transverse and anterior-posterior dimensions
- Measurement of the gall bladder wall
- Measurement of the common bile duct in the region of the porta hepatis

### **9.3.7 Handling the Ultrasound Images**

Clinical Center staff will forward original ultrasound images to the Medical Coordinating Center (MCC) with a transmittal form (BABY HUG Form 112). Images will be provided on hard-copy film with no more than 12 images per sheet (14" X 17") of film.

The ultrasound images will be accompanied by the following information:

- Proper Identification (Patient 5-digit label number and date)
- Patient's Age
- Patient's Body Length
- Patient's Body Weight
- NPO Status (how long they were held NPO)

The MCC will log receipt of the films, and forward them to the central reader with a blank Abdominal Sonogram Reading Form (Form 85). The reader will complete Form 85 and return the films and form to the MCC. MCC coordination staff will data enter the form.

#### **9.4 CLINICAL EVENTS**

Clinical events will be described on Form 50 (Reportable Event and/or Hospitalization) which the Clinical Center submits to the Medical Coordinating Center (MCC) at the time of the event. For Severe Adverse Events, the MCC will send the Form 50 and all supporting documentation to two independent pediatric hematologists for their review, along with Form 87 (Clinical Events Classification). The reviewers will classify the event according to the definitions in Appendix F of the Protocol and record their assessments on Form 87. They will return the completed forms to the MCC and MCC coordination staff will data enter the forms. MCC computing staff will compare the two reviews. If they agree, the classification is final. If they disagree, independent review for adjudication by a third physician will be performed.

#### **9.5 REFERENCES**

1. Dittrich M, Milde S, Dinkel E, Baumann W, Weitzel D. Sonographic biometry of liver and spleen size in childhood. *Pediatr Radiol* (1983) 13:206-211
2. Dinkel E, Ertel M, Dittrich M, Peters H, Berres M, Schulte-Wissermann H. Kidney size in childhood: Sonographical growth charts for kidney length and volume. *Pediatr Radiol* (1985) Volume 15, Number 1:38-43
3. Carroll, BA, Oppenheimer, DA, Muller HH. High-Frequency Real-Time Ultrasound of the Neonatal Biliary System. *Radiology* (1982) 145:437-440
4. Matos C, Avni EF, Van Gansbeke D, Pardou A, Struyven J. Total Parenteral Nutrition (TPN) and Gallbladder Diseases in Neonates – Sonographic Assessment. *J Ultrasound Med* (1987) 6:243-248

**PEDIATRIC HYDROXYUREA PHASE III CLINICAL TRIAL (BABY HUG)  
MANUAL OF OPERATIONS**

**CHAPTER 10**

**DATA COLLECTION, ENTRY, EDITING, STORAGE AND ARCHIVAL**

**10.1 CLINICAL CENTER DATA**

**10.1.1 Data Collection**

Chapter 12 of the Protocol describes the specifics of the conduct of the clinical trial, including commentary about data collection. The Medical Coordinating Center (MCC) is the repository of all data. All BABY HUG data collection forms and transmittal lists for blood specimens and other materials (e.g., images) shipped in the course of BABY HUG data collection will be sent to the MCC via Internet data entry. Clinical Center personnel will use the Internet Data Entry System to send data in electronic format to the MCC.

Data collection at the Clinical Centers, and core laboratory and central reader results, will provide the data set to answer the study's primary objectives and key questions. Missing data may bring the study to an end without an answer so it is imperative that all the data be captured and sent to the MCC on the expected dates. The expected dates for completed forms are as follows:

- One week after each pre-enrollment visit for Eligibility Forms and associated special study forms
- One week after the study entry visit for Form 22
- By 10:00 a.m. EST the day following the visit for Forms 21 and 31
- Immediately after the visit's Extended Window has expired for Missed Visit Forms
- Within 24 hours of the blood draw or by 9:00 a.m. EST the day following the visit for the Local CBC Results (Form 37)
- Prior to shipment (day of collection or batched) for specimen Transmittal Forms

- Two days after knowledge of the adverse event for Adverse Event Report Forms
- One week for Imaging Study Transmittal Forms

Data not sent to the MCC within the extended window will be denoted as delinquent.

Coordinators may want to keep a supply of blank study forms in a file drawer, in folders labeled with the form number. Paper copies of the forms can be printed off the BABY HUG website by accessing “Forms” on the BABY HUG home page (see MOO Section 17.2). As information is gathered by interview and medical record review, it can be recorded on the appropriate form. These can be considered working data collection forms, which will provide the information necessary for Internet data entry.

Each study form **MUST** have an index form. The index form can be either the original paper form completed before data entry or it can be the first printout of the study form after it is keyed. All index forms must be signed and dated. All modifications to the index form must be properly recorded (data crossed out so that the original text is still readable, initialed and dated). The study index form must be kept in a manner acceptable for regulatory purposes.

### **10.1.2 Data Entry**

Accurate data entry is crucial to the success of the study. All of the report forms for data entry are on the BABY HUG website. QxQs for each of the forms are also on the website. The Internet Data Entry System has been developed to allow entry of data as it becomes available and preliminary editing at the time of data entry. Time critical information must be available to adequately monitor BABY HUG patients for safety and to keep them on study treatments. The data are registered in the central data base immediately after saving the data. Time-critical forms, such as the Study Visit Form (Form 31), Treatment Initiation (Form 21) and Local CBC Results (Form 37) must be entered on a timely basis and take priority over other forms that are not time-critical.

To aid in learning about the Internet Data Entry System, a training segment entitled “Using the BABY HUG Web System: Internet Data Entry” is posted on the website under “Presentations.” The essential elements of this session are presented below.

### **10.1.2.1 Internet Data Entry System User Access**

Before you can enter data into the Internet Data Entry System, you must be authorized to have “Data Entry and Content” use of the BABY HUG system (see MOO Section 17.4). The contents of the BABY HUG website, including the computer system requirements to access the site, are described in MOO Chapter 17. The MCC will send each certified user a permanent username and password, which will be required for data entry.

### **10.1.2.2 J-initiator**

The J-initiator is a required piece of software which enables users to run ORACLE Forms Server Applications on the BABY HUG website. It must be downloaded to the computer that will be used for data entry from the Data Entry Set Up J-initiator download page. The download page is displayed automatically the first time a user selects ‘Form Entry’ at the BABY HUG website homepage. The download procedure is required only once on any given computer. Follow the instructions, which allow the user to select Sockets connection mode between the PC and the forms server. After the selection, press ‘Update Mode’, which writes the connection mode to the computer as a cookie.

### **10.1.2.3 Form Selection**

At the BABY HUG website home page, select ‘Form Entry’. “Loading Java Applet...” will appear on the study form entry page and then ‘ORACLE Developer Server’ will appear. There is a delay, so users need to be patient. Two boxes will appear, overlapping each other. The first is the Baby Hug Form Process Selection screen. Overlying is the ‘Select a Form’ box with a scroll bar on the right.

To select a study form, scroll to the desired form and select it or type in the form number. Click OK or double-click on the study form number. The first two digits is the form number, the third digit is the revision number.

To select a transmittal form, click on ‘Cancel’ at the bottom of the ‘Select a Form’ box. Then select ‘Transmittal Forms’ at the bottom of the BABY HUG Form Process Selection screen. Scroll

to the desired transmittal form in the pop-up box and select it. Click OK or double-click on the Core Laboratory name.

#### **10.1.2.4 Study Form Function**

In the Function box on the Baby Hug Form Process Selection screen, click on 'Entry' for initial data entry or 'Corrections' to modify or add to data already entered for a form. Make sure that the status bar is visible at the bottom of screen. If not, reposition the screen with a click and drag maneuver.

#### **10.1.2.5 Entering Study Form Data**

Identifying Information Fields. Identifying information includes:

- Enrolling Site Number
- Patient Identification Number
- Patient Letter Code
- Visit
- Sequence Number
- Date

There is a Help Menu for the Visit and Date fields. Position the cursor in the desired field and from the Help Menu select 'List'. A drop down box will appear with possible selections for that field for that particular patient for that form, at that time. After entering all the identifying information, press the <Enter> key or click on OK. The system then performs a check of the patient identifying data. A message box will pop up if there is an identifying information error. Select the OK button to clear the message box. Common identifying information errors are:

- The patient does not exist in the system
- The Letter Code is wrong
- Incorrect visit
- Date is more than one year ago. A 'warning' message box appears.
- Date is greater than today

- Out of acceptable time window

#### Study Data Fields.

**Bubbles:** Click on the bubble to select an answer. To change an answer, click on another bubble. To remove a response, click on the 'clear' bubble.

**Write-in items:** If completely filled they will auto-skip to next item; if not completely filled in, press <enter>.

**Check boxes:** Click on boxes to toggle between on/off.

Signature Field. Do not try to key the signature. Click on the check box if the signature exists or leave the check box un-clicked if no signature exists. The signature should be of the person responsible for the data reported on the form.

Comment Field. Key a "1" in the field. A separate screen will be displayed to enter comments up to 250 characters in length. After entering the comment, select the OK button. A message box will indicate that the comment has been saved to the database. Click OK.

#### Form Entry Tips.

- Use the Page Tabs (1, 2, 3, etc.) located on the left margin of the data entry screen.
- Use the Scroll Bar at the right side of the data entry screen to move down the page.
- Watch for informational and error messages on the Status Bar, which is on the bottom of the data entry screen. An example of an error message on the Status Bar is "Not a valid month name". This indicates that the format entered for the date is not correct. Dates should be entered in MON-DD-YYYY format, using the first three letters of the month.

#### **10.1.2.6 Entering Transmittal Form Data**

Once a transmittal form is selected, the BABY HUG Internet Data Entry System will automatically populate the Core Laboratory name and the Clinical Center number data fields. The

ship date will also be automatically be populated with the current date; this date can be modified if the ship date is not the current date.

All the data fields are write-in items. If they are completely filled in, they will auto-skip to the next item; if not completely filled in, press <enter>. Type in the name and certification number of the Clinical Center staff member preparing the transmittal form. If the FedEx tracking number is known, enter it. Any comments about the specimens or the shipment may be entered in the comments field.

The 5-digit label number can be either typed in or selected from the pop-up box. All transmittal forms require the specimen date, and some require additional information for processing.

#### **10.1.2.7 Save Your Work**

If all the data are keyed, check the 'form complete and ready to edit' box to allow the edit program to run. When finished, select 'Action' and then 'Save'. Review your answers and select 'Action' and then 'Save' a second time to commit your data entry to the database. *Data must be saved twice to be saved to the data base.* If you do not want to save the data you entered, select 'Action' and then 'Exit'.



### **10.1.2.8 Forms That Fail Edit**

If after you have checked the 'form complete and ready to edit' box and the form fails edit, two windows will open up. One is a password box. After entering your password, a 'Baby Hug Edit Query' report will appear, which gives a detailed explanation for why the form failed edit. The Edit Query report can be printed by clicking on the print button. The form that generated the Edit Query report also can be printed.

### **10.1.2.9 Internet Failure**

In the event that time-critical forms cannot be transmitted due to equipment failure, e.g. the server is down at the MCC or at the Clinical Center, the forms should be faxed to the MCC using the dedicated BABY HUG fax line, and if fax communication is not possible, the form information should be telephoned in to the MCC.

### **10.1.3 Data Editing**

Form edits will be required from time to time. Many data entry fields on the study forms are programmed with a range of acceptable values or responses. Values entered that fall outside of those acceptable ranges will generate an edit report. Also, values that are inconsistent with other values (the answer to one question may be based on the answer to another question), will generate a data edit report. The Internet Data Entry System provides rapid feedback regarding such edits, as queries are generated when the form closes. In reviewing the edit report, it may be necessary to go back to the index study form or medical record to see if the value was transcribed correctly or incorrectly into the Internet Data Entry System. Edit reports will also be generated if a required field on a form was left blank. Again, the index study form may need to be reviewed to see if the value is available.

#### **10.1.3.1 Corrections Function**

The Internet Data Entry System has a corrections function, which allows one to change data that have already been submitted electronically on a study form to the MCC. It also allows for printing and running the edit program. The identifying information must match the original entry in

order to pull up the form to be modified. In the Function box in the Baby Hug Form Process Selection box, click on 'Corrections' then press <Enter> or click on the OK button. Make the corrections to the data, e.g. by selecting the correct answer if it is a bubble response. Remember to save the edited form by selecting the 'Action'/'Save' sequence twice. If all the data are keyed, make sure the 'form complete and ready to edit' box is checked to allow the edit program to run again. To re-print the form, open up the form from the Corrections function and select 'Action' and 'Exit'. Then click on Yes or press <Enter>. The Password window will pop up. After the password is entered, click on the print icon to print the form.

#### **10.1.3.2 Editing Data on Archived Documents**

All corrections to previously entered data must also be recorded on the index study form. Draw a line through the previous response. Write the initials and date next to the previous response. Write in the new response, being careful not to obscure the original response.

#### **10.1.4 Storage and Archival**

All archived documents, such as paper forms or computer printouts of the Internet Data Entry System forms, must be signed and dated before they are placed in storage. Archived documents must be stored with other confidential patient files in a locked cabinet or file drawer. Each BABY HUG patient should have a set of files (see MOO Chapter 6.3) organized in such a fashion that any particular document can be easily located and retrieved. Because data entry is performed at the Clinical Centers which are remote from the MCC, data quality assurance will be derived from site visits that will include audits of the data against the medical record. The MCC may periodically check the quality of the Clinical Center data entry by requesting copies of the original forms for independent data entry and comparison. It therefore becomes critical to store patient files in an orderly fashion to facilitate easy retrieval.

## **10.2 CENTRAL READER DATA**

The Clinical Centers send to the Medical Coordinating Center (MCC) all liver/spleen scan and abdominal sonogram films for central reading. The MCC will log receipt of the films and forward the films and a grading form to the appropriate readers.

### **10.2.1 Liver/Spleen Scans**

The MCC will send the liver/spleen scan films and a blank Form 84 (Liver-Spleen Scan Central Reading) to the first central reader who will assess and grade the films for uptake in the spleen compared to that in the liver. The reviewer will complete Parts II-III of the form, and return the study form and films to the MCC. The MCC coordinator will log receipt of the films, and forward the films with a blank Form 84 to the second reader who will return the films and form to the MCC. If the two gradings disagree, the MCC coordinator will send the films and a blank study form to a third reviewer. The MCC coordinator will complete the remaining sections of the study forms and use the Internet Data Entry System (see Section 10.1) to enter and edit (if necessary) the data on the study forms. The original forms (the study index forms) and the films will be stored in a locked location at the MCC.

### **10.2.2 Abdominal Sonogram**

The MCC will send the abdominal sonogram films and a blank Form 85 (Abdominal Sonogram Central Reading) to the central reader who will grade the films for splenic and renal volume, and assess the gallbladder and biliary system. The reviewer will complete Parts II-III of the form and return the study form and films to the MCC. The MCC coordinator will log receipt of the films, complete the remaining sections of the form and data-enter the form. The MCC coordinator will use the Internet Data Entry System (see Section 10.1) to enter and edit (if necessary) the data on the study form. The original form (the study index form) and the films will be stored in a locked location at the MCC.

### **10.2.3 Clinical Events Classification**

The MCC will send all Severe Adverse Event Form 50s (Reportable Event and/or Hospitalization), laboratory results and any other pertinent information and a blank Form 87 (Clinical Events Classification) to the two central reviewers. The reviewers will complete Parts II-IV of the form, and return the study form to the MCC. If the two readers disagree, the MCC will send the identical materials to a third reader for adjudication. The MCC coordinator will complete the remaining sections of the study forms and use the Internet Data Entry System (see Section 10.1) to enter and edit (if necessary) the data on the study form. The original forms (the study index forms) will be stored in a locked location at the MCC.

### **10.3 CORE LABORATORY DATA**

The Clinical Centers send all blood and urine specimens directly to the appropriate Core Laboratory. All Core Laboratories (Hematology, Biochemistry, Cytogenetics, Immunology, Pitted Cell Count, DNA, and HU Assay) will send test results in electronic format to the Medical Coordinating Center (MCC). Each Core Laboratory will write the test results (delineated by label number) to an Excel spreadsheet which will be sent via email to the MCC. Included in the test results will be the specimen's condition upon receipt at the laboratory. Upon receipt of the Excel spreadsheet at the MCC, MCC programming staff will upload the test results and process them into the database. If the test results are incomplete, the Core Laboratory will resend the complete record for the specimen when the test results are available.

**PEDIATRIC HYDROXYUREA PHASE III CLINICAL TRIAL (BABY HUG)  
MANUAL OF OPERATIONS**

**CHAPTER 11**

**TRAINING AND CERTIFICATION**

**11.1 INTRODUCTION**

In multi-center clinical trials, procedures must be standardized within each Clinical Center and among the participating Clinical Centers to assure that findings from all centers are comparable and, therefore, can be pooled. Certification of Clinical Centers and their staff indicates that they have been instructed in the study procedures or demonstrated that they can perform them. Specifically, each BABY HUG Clinical Center must be certified to recruit, screen, enroll, treat and collect outcome data from patients and their families. Staff who will be responsible for BABY HUG screening and study procedures, enrolling patients, completing BABY HUG data collection forms, performing data entry and/or sending study specimens to Core Laboratories must be certified. This chapter specifies the requirements for certification of Clinical Centers and their personnel and the responsibilities of the Medical Coordinating Center (MCC) for coordinating the certification program.

**11.2 TRAINING**

Before the start of the study, the MCC organized training sessions led by BABY HUG investigators for Clinical Center personnel. The training sessions provided instruction on conducting eligibility assessments, use of the telephone randomization system, conduct of clinic visits, completion of study forms, data entry and editing of study forms over the Internet, maintenance of study and patient data files, study treatment distribution, treatment initiation, specimen labeling, adverse event reporting, treatment unblinding and study monitoring. In addition, special study procedures were reviewed and Hematology and Biochemistry Core Laboratory personnel presented procedures for collecting and shipping study specimens. If new personnel or Clinical Centers join the study while it is in progress, training could be provided by previously

certified Clinical Center staff or special training sessions could be scheduled at the MCC or in conjunction with a site visit to the Clinical Center.

### **11.3 CLINICAL CENTER CERTIFICATION**

In order for a BABY HUG Clinical Center to be certified to recruit, screen and treat patients, the following requirements must be met.

1. Documentation of approval by local Institutional Review Board (IRB) of the BABY HUG Protocol and Consent Form, by submission of copies of approvals to the MCC. A copy of the Consent Form must be sent to the MCC whenever it is revised. Notification of annual IRB approval is also required.
2. Approval by the DSMB Chair of the Clinical Center consent form.
3. Approval by local institution of a Health Insurance Portability and Accountability Act of 1996 (HIPPA) Privacy Rule Authorization form.
4. Identification of a Patient/Family advocate.
5. Submission of an original, signed U.S. Federal Drug Administration (FDA) Form 1572 for the BABY HUG Investigational New Drug (IND) application.
6. Submission of Conflict of Interest statements (Exhibit 11-1) to the MCC for the following BABY HUG staff members: Principal Investigator, Co-Principal Investigator, Clinic Coordinator, Data Manager, Neuropsychologist, Neurologist, Pharmacist and Primary Endpoint Person. These forms are to be resubmitted (updated) annually.
7. Submission of a BABY HUG website site application (see Exhibit 17-2 in Chapter 17).
8. Submission of an Automated Telephone Response System (ATRS) site application (see Exhibit 4-1 in Chapter 4), identifying the persons at the Clinical Center who will be responsible for enrolling patients in the study. At least one of these persons

must be certified to use the ATRS to allocate a random treatment assignment before the Clinical Center can be certified.

9. Certification of at least one individual in each of the following staff categories: Principal Investigator, Clinic Coordinator, neuropsychologist, neurologist, Clinical Center pharmacist and Primary Endpoint Person.
10. Human subjects training completed for all staff in contact with BABY HUG patients, their families, specimens or data.

Clinical Centers cannot begin recruitment before all certification requirements have been met (see Exhibit 11-13). When all requirements have been completed, the Principal Investigator of the Clinical Center applies for certification by submitting to the MCC a completed Request for Clinical Center Certification (see Exhibit 11-2, BABY HUG Form 121). If all requirements are met, the MCC will notify the Clinical Center of certification by forwarding a completed copy of BABY HUG Form 122, Notification of Clinical Center Certification (Exhibit 11-3).

#### **11.4 CERTIFICATION OF CLINICAL CENTER PERSONNEL**

Each Clinical Center participating in BABY HUG is required to have one or more individuals on the staff certified and/or registered in each of the following categories in order to recruit and treat BABY HUG patients.

- Principal Investigator
- Clinic Coordinator
- ATRS
- Neuropsychologist
- Neurologist
- Pharmacist
- Primary Endpoint Person

In addition, all BABY HUG personnel examining patients or completing study forms are

required to be registered and are assigned a BABY HUG certification number.

Training and/or experience is required for each individual to be certified. All persons requesting certification or registration are expected to have read the BABY HUG Protocol and appropriate sections of the Manual of Operations. In general, practical experience in following BABY HUG procedures and completing BABY HUG data collection forms is necessary. Exhibit 11-4 identifies the allowable BABY HUG forms that can be entered into the database by Clinical Center personnel during the study.

Individuals request certification or registration in any of the above categories by submitting the appropriate Request for Certification. Specific requirements must be met in each category in order to be eligible for certification. These requirements are discussed in the subsequent subsections. Once the required materials are submitted to the MCC for review and assessed as satisfactory, certification or registration is provided in writing and a BABY HUG certification number is assigned. An updated Certification List will be sent to the Clinical Center (See Exhibit 11-5, BABY HUG Form 120) via secure transmission every time a new staff person has been certified; this will be the mechanism used to inform the Clinical Center of the assigned certification numbers.

#### **11.4.1 Principal Investigator**

Each Clinical Center's Principal Investigator must meet the following requirements.

1. Attendance at a BABY HUG training session.
2. Successful completion of the BABY HUG general knowledge test (see Exhibit 11-6).
3. Submit a Request for Clinical Center Certification (see Exhibit 11-2, BABY HUG Form 121).

All *co-investigators* who are empowered to prescribe study treatment (e.g., as listed on the Clinical Center's FDA Form 1572) must successfully complete the BABY HUG general knowledge test and submit a Request for Co-Investigator Certification (Exhibit 11-7, BABY HUG Form 123). In addition, an individual who is a Co-Principal Investigator must also either attend a BABY HUG



training session or be trained by a certified Principal Investigator.

#### **11.4.2 Clinic Coordinator**

Requirements for certification of Clinic Coordinators focus on their primary role in assuring the quality and completeness of data entered into the BABY HUG database via the Internet. These are:

1. Attendance at a BABY HUG training session or training by a certified Clinic Coordinator.
2. Certification in anthropometry at a BABY HUG training session or by a Clinic Coordinator who is certified in anthropometry.
3. Successful completion of the BABY HUG general knowledge test (see Exhibit 11-6).
4. Submission of a completed BABY HUG website individual application.
5. Successful completion and data entry of BABY HUG Forms 05 (Eligibility Screening II) and 31 (Study Visit) for a standard set of patient information. Exhibit 11-8 contains the standard patient narratives and label sheets required for completion of these study forms.
6. Submit a Request for Clinic Coordinator Certification (see Exhibit 11-9, BABY HUG Form 124).

*Data managers* must meet the same requirements for certification as a Clinic Coordinator.

#### **11.4.3 ATRS User**

Each individual authorized to randomize and enroll patients must practice at least once before being certified and eligible to use the Automated Telephone Randomization System (ATRS). In addition to being certified for the ATRS, individuals can be certified for other Clinical Center functions (e.g., Clinic Coordinator). Instructions for practicing on the ATRS are specified in Chapter 4.2 of the Manual of Operations. At the end of the practice session, the ATRS indicates the status of the practice session. The Principal Investigator of the Clinical Center specifies on the Request

for Clinical Center Certification the individuals who have successfully completed an ATRS practice session and thus are eligible to enroll patients for that Clinical Center. Thus, the requirements for ATRS certification are:

1. Successful completion of an ATRS practice session.
2. Be identified on the Request for Clinical Center Certification (Exhibit 11-2, BABY HUG Form 121).

The ATRS practice system will remain in place for the duration of the study. If Clinical Center personnel need additional practice using the system after certification, or if new personnel are assigned to enroll patients, the practice system can be used for these purposes. If additional personnel are certified to use the ATRS system, they can be identified to the MCC by sending a photocopy of the original Request for Clinical Center Certification (Form 121) with the names of the newly certified users written on the form.

#### **11.4.4 Neuropsychologist**

Each Clinical Center must have a neuropsychologist certified to conduct the Bayley and Vineland evaluations. If a Clinical Center uses a consortium of neuropsychologists, only the lead neuropsychologist needs to be certified. The Clinical Center neuropsychologist is responsible for each test administered by a neuropsychology tester under the neuropsychologist's direction and for maintaining documentation of each tester's performance of each test. Each neuropsychologist wishing to be certified in BABY HUG must have:

1. Experience (administering or supervising) both the Bayley and Vineland evaluations.  
The MCC has available Vineland training CD-ROMs for loan to Clinical Centers.
2. Practice with completion of Forms 40 (Bayley) and 41 (Vineland).
3. Submit a Request for Neuropsychologist Certification (Exhibit 11-10, BABY HUG Form 125).

#### **11.4.5 Neurologist**

Each Clinical Center must have a neurologist certified to perform the neurological examination and evaluation. The certification requirements are:

1. Board certified pediatric neurologist.
2. Performed the BABY HUG or Pediatric AIDS Clinical Trials Group examination at least once.
3. Practice with completion of Form 43 (Neurological Exam and Evaluation).
4. Submit a Request for Neurologist Certification (Exhibit 11-11, BABY HUG Form 126).

#### **11.4.6 Pharmacist**

Every Clinical Center will have a Clinical Center pharmacist who will dispense study treatment. Certification of this individual requires:

1. Receive training on BABY HUG Clinical Center pharmacy procedures by a certified Principal Investigator or Clinic Coordinator.
2. Be identified on the Request for Clinical Center Certification (Exhibit 11-2, BABY HUG Form 121).

If additional Clinical Center pharmacists are certified to dispense study treatment after the study begins, they can be identified to the MCC by sending a photocopy of the original Request for Clinical Center Certification (Form 121) with the names of the newly certified pharmacists written on the form.

#### **11.4.7 Primary Endpoint Person**

Requirements for certification of the Primary Endpoint Person (PEP) focus on their primary role in assuring the quality and completeness of data entered into the BABY HUG database via the Internet. These are:

1. Attendance at a BABY HUG training session or training by a certified Clinic Coordinator.

2. Successful completion of the BABY HUG general knowledge test (see Exhibit 11-6).
3. Submission of a completed BABY HUG website individual application.
4. Successful completion and data entry of BABY HUG Forms 05 (Eligibility Screening II) and 31 (Study Visit) for a standard set of patient information. Exhibit 11-8 contains the standard patient narratives and label sheets required for completion of these study forms.
5. Submit a Request for Primary Endpoint Person Certification (see Exhibit 11-12, BABY HUG Form 127).

### **11.5 ROLE OF THE MEDICAL COORDINATING CENTER IN CERTIFICATION**

The tasks related to the certification program for which the MCC staff has responsibility for are:

- a. Documentation of certification procedures,
- b. Coordination of, and participation in, training sessions,
- c. Distribution, receipt and review of certification materials,
- d. Documentation of the completion status of certification requirements for Clinical Centers and Clinical Center staff,
- e. Certification of Clinical Centers and Clinical Center staff, and
- f. Issue certification numbers to Clinical Center staff.

#### **11.5.1 Processing Requests for Certification of Clinical Center Staff**

An individual at the MCC processes all requests for certification. Upon receipt of a request for certification, the MCC reviews the materials in the certification file maintained for each Clinical Center to assure that all required materials have been received. Requests for certification are then reviewed by designated MCC staff.

#### **11.5.2 Certification of Clinical Center Staff**

MCC staff is responsible for review of certification materials submitted for Clinical Center staff. Review is carried out by one member of the MCC and approved by another.

### **11.5.3 Notification of Certification**

After review of submitted materials, if certification is recommended, the MCC will assign a unique BABY HUG staff number to the individual. An updated Certification List will be sent to the Clinical Center (See Exhibit 11-5, BABY HUG Form 120) with the new certification number listed next to the individual's name.

If certification is not recommended, problems will be identified and proper procedures reviewed. Individuals will be asked to submit additional materials which will once again be reviewed. If the Clinical Center Principal Investigator disagrees with a recommendation against certification, the Operations Committee is notified.

### **11.5.4 Processing Requests for Certification of Clinical Centers**

Requests for Clinical Center certification are also logged at the MCC and each is reviewed to assure that the required staff has been certified and that all requirements have been met. The MCC notifies each Clinical Center of certification to begin patient recruitment by forwarding a completed copy of BABY HUG Form 122, Notification of Clinical Center Certification (Exhibit 11-3).

### **11.5.5 Liaison Activities**

The Certification Coordinator maintains regular telephone communications with staff in each Clinical Center to detect and help to resolve any problems encountered in the certification process. Problems which the MCC is unable to resolve are referred to the Operations Committee.

## **11.6 RENEWING CLINIC COORDINATOR CERTIFICATION**

Ongoing review of Clinical Coordinator performance is undertaken by the MCC staff. The quality, completeness and timeliness of the BABY HUG forms as well as the timeliness of response to edit messages and memoranda are the primary criteria used in evaluation. Coordinators whose forms are completed within windows over 90% of the time and whose forms are passing edit over

90% of the time will automatically be given annual renewal of certification.

If a Clinic Coordinator fails to meet the standards necessary for conduct of BABY HUG, the MCC staff will review the problem(s) with the Operations Committee with a request to the Chairman that the Principal Investigator be contacted to review the problem(s) and solicit any explanation(s). If the MCC staff document no improvement within two months of the date the problem is reviewed by the Operations Committee Chairman with the Principal Investigator, the MCC staff will notify the appropriate individual in writing that his/her certification has been suspended, and other Clinical Center staff will be responsible for the integrity of the performance of the tasks of that coordinator. Copies of this letter will be sent to the Principal Investigator and the Operations Committee. A staff member who has had certification suspended will be re-certified when all of the following conditions have been met: (1) at least 15 forms or two months' work have been reviewed and co-signed by the Principal Investigator and all are satisfactory, (2) any outstanding edit messages and memoranda responses have been received and are satisfactory, and (3) current work is satisfactory and is submitted in a timely fashion.

In the extenuating circumstance when no certified Clinic Coordinator is available at the Clinical Center due to illness or other unexpected events or while new staff are being recruited and certified, BABY HUG forms will be accepted by the MCC if each form is reviewed and co-signed by the Principal Investigator.

Pediatric Hydroxyurea Phase III Clinical Trial  
BABY HUG  
FINANCIAL DISCLOSURE

I, the undersigned, certify that:

1. As of \_\_\_\_\_, neither I, nor my spouse or dependent children own or will buy or trade stock or stock options in any of the companies\* providing medication, equipment or financial support in the trial. In addition, I don't have a retainer-type consultant position with any of the companies.\*
2. I agree to disclose financial interests as outlined in the BABY HUG Clinical Trial Policy on Conflict-of-Interest during my participation in the BABY HUG Clinical Trial.

If response is no to questions 1 or 2, an explanatory letter is required.

\_\_\_\_\_  
Typed or Printed Name

\_\_\_\_\_  
Signature

\_\_\_\_\_  
Date

\* Companies include: Bristol-Myers Squibb, Par Pharmaceuticals, Inc.

**EXHIBIT 11-2**  
**PEDIATRIC HYDROXYUREA CLINICAL TRIAL**  
**REQUEST FOR CLINICAL CENTER CERTIFICATION**  
**FOR PARTICIPATION IN BABY HUG**

BABY HUG Form 121  
 Rev 1 06/01/05  
 Page 1 of 2

Clinical Center: \_\_\_\_\_

Clinical Center No.: \_\_\_\_\_

This form is to be completed, signed, and submitted to the Medical Coordinating Center by the Principal Investigator when the Clinical Center is ready to begin recruitment. In order to begin recruitment for BABY HUG, all items on this form must be completed and all required documentation submitted to the MCC. The completed form will be reviewed by the Operations Committee. Permission to initiate recruitment is contingent upon approval of the Operations Committee and the

**PART I: CERTIFIED/REGISTERED STAFF AVAILABLE**

Name	BABY HUG CERT NO.	Certification/Registration		
		Month	Day	Year
A. Clinic Coordinator(s)	-			
_____	- - - -	- - - -	- - - -	- - - -
_____	- - - -	- - - -	- - - -	- - - -
_____	- - - -	- - - -	- - - -	- - - -
B. Neuropsychologist	-			
_____	- - - -	- - - -	- - - -	- - - -
C. Neurologist	-			
_____	- - - -	- - - -	- - - -	- - - -
C. Primary Endpoint Person	-			
_____	- - - -	- - - -	- - - -	- - - -



**PART II: PRINCIPAL INVESTIGATOR ASSURANCES FOR OTHER REQUIRED STAFF**

A. ATRS User(s): The following individual(s) are certified ATRS users.

---

---

---

B. Pharmacist: The following individual(s) meet the certification requirements for a BABY HUG pharmacist.

---

C. Patient/Family Advocate.

---

**PART III: SUBMISSION OF DOCUMENTS** (all MUST be checked)

- \*  Copy of local IRB approved Protocol
- \*  Copy of local IRB approved Consent Form
- \*  Institution approved HIPAA authorization form
- \*  Original FDA Form 1572
- \*  Original Conflict of Interest statements for required BABY HUG staff
- \*  Original BABY HUG website application
- \*  Human subjects training completed for all staff in contact with BABY HUG patients, their families, specimens or data
- \*  BABY HUG general knowledge test completed by PI

\* To be submitted with this form if not previously submitted.

**PART IV: CERTIFICATION REQUEST**

This Clinical Center has completed all procedures required for certification and I believe we are ready to begin recruitment of BABY HUG patients.

---

Principal Investigator's Signature \_\_\_\_\_ Month \_\_\_\_\_ Day \_\_\_\_\_ Year \_\_\_\_\_

Certification No.: \_\_\_\_\_ - 0 \_\_\_\_\_ 1  
Clinic #

**EXHIBIT 11-3**  
PEDIATRIC HYDROXYUREA CLINICAL TRIAL  
**NOTIFICATION OF CLINICAL CENTER CERTIFICATION**

BABY HUG Form 122  
Rev 0 08/07/03  
Page 1 of 1

Clinical Center: \_\_\_\_\_ Clinical Center No.: \_\_\_\_

Principal Investigator: \_\_\_\_\_

Your Clinical Center has been certified to begin recruitment of patients for BABY HUG.

Approved by: \_\_\_\_\_

Date: \_\_\_\_\_

**EXHIBIT 11-4**

**Data Entry of Forms by BABY HUG Personnel\***

Form	PI	CC	PEP	NEURO	NPSYC	LS-Cen	SON-Cen	TCD	CE	MCC
04	x	x								
05	x	x								
06	x	x								
07	x	x								
08	x	x								
20	x	x								
21	x	x								
22			x							
23	x	x								
31	x	x								
32	x	x								
33	x	x								
34	x	x								
35	x	x								
36	x	x								
37			x							
38	x	x								
40	x	x			x					
41	x	x			x					
42	x	x								
43	x	x								
44			x							
45	x	x								
46	x	x						x		
50			x							
64	x	x								
65										x
66	x	x								
80	x	x				x	x	x		x
84						x				x
85							x			x
87									x	x

- \* CC            Clinic Coordinator and Clinic Coordinating Center staff
- CE            Clinical Events central reader
- LS-Cen       Liver/Spleen Scan central reader
- MCC          Medical Coordinating Center
- NEURO       Neurologist
- NPSYC       Neuropsychologists and Neuropsych staff
- PEP          Primary Endpoint Person
- PI            Principal Investigator and Co-Principal Investigator
- SON-Cen     Abdominal Sonogram central reader
- TCD          TCD staff



## EXHIBIT 11-6

### BABY HUG Certification Test

1. What are the study treatments in BABY HUG? (select two)
  - a. Ibuprofen
  - b. Placebo
  - c. Penicillin
  - d. Phenytoin
  - e. Hydroxyurea
  
2. What are the primary outcomes of BABY HUG (select two)
  - a. Dactylitis
  - b. Elevated glomerular filtration rate (GFR)
  - c. Splenic sequestration
  - d. Cerebral infarction
  - e. Change in radionuclide splenic activity
  
3. How many different Clinical Centers are in BABY HUG? (select one)
  - a. 4
  - b. 10
  - c. 14
  - d. 20
  - e. 25
  
4. How many children will be enrolled in the full Pediatric Hydroxyurea Phase III Clinical Trial (BABY HUG)? (select one)
  - a. 20
  - b. 40
  - c. 80
  - d. 200
  - e. 240
  
5. How long does study treatment continue in the full Pediatric Hydroxyurea Phase III Clinical Trial (BABY HUG)? (select one)
  - a. Six months
  - b. One year
  - c. Two years
  - d. Three years
  - e. Five year
  
6. Is a child who has had a stroke eligible for BABY HUG?
  - a. Yes
  - b. No
  
7. Is a child who has hemoglobin SC disease eligible for BABY HUG?
  - a. Yes
  - b. No

**EXHIBIT 11-6, cont.**

8. Is a child with a non-functioning spleen eligible for BABY HUG?
  - a. Yes
  - b. No
  
9. Which of the following ages are in the eligibility range for the full Phase III BABY HUG study? (select all that apply)
  - a. 6 months
  - b. 10 months
  - c. 15 months
  - d. 19 months
  - e. 24 months

Name: \_\_\_\_\_

Signature: \_\_\_\_\_

Date: \_\_\_\_\_

Clinical Center No.: \_\_\_\_



**EXHIBIT 11-8**  
**Standard Patient Narratives**

Note:

- (1) Before entering Forms 05 and 31, enter Part I and the birth date in Form 04 first. Use a birth date of Jul 1, 2005. Use the same identifying information in Part I for Forms 04, 05 and 31.
- (2) When completing the forms, write in label numbers on the forms using numbers from the attached label sheet. Progress through the rows of numbers as if you were actually affixing labels to the forms.

**Form 05 (Eligibility Screening II)**

Clinic Note

TXR Patient ID number 9x-\_\_ \_\_ where x = clinic number (e.g. 4 for Clinic 04)

Clinic Number 99

Mar 1, 2006

TXR is a 16-month-old African American female with Hb SS disease, here today for the eligibility screen II visit of the BABY HUG protocol.

She has had one admission x 3 days for fever with presumed viral illness 4 months ago, no surgeries, and she has never received a blood transfusion. She is UTD with her immunizations and has no known allergies. She is currently taking Pen VK 125 mg BID.

On physical examination her temperature was 37.0° C, pulse rate 90/minute, respiratory rate 28/minute, blood pressure 104/64 mmHg, recumbent length 75 cm x 2 (40<sup>th</sup> %), weight 12.5 kg, 12.0 kg, 12.5 kg (40%), and HC 49.0 cm, 49.5 cm, 49.5 cm (40%) with some interference in length and HC because of braids. Her oxygen saturation was 100% x 2. She is playful and well appearing. TMs are clear; oropharynx shows enlarged 3+ tonsils with no exudate or erythema. No palpable lymph nodes. Heart rate is regular with a II/VI systolic ejection murmur. Lungs are clear to auscultation. Abdomen is soft, non-tender, non-distended, no hepatosplenomegaly. Normal extremities. Normal female genitalia. Tanner stage I.

Lab samples drawn and shipped via FedEx to the core laboratories today include the hematology, pitted red cell counts, and cytogenetics.

Recent BABY HUG testing includes:

1. The Eligibility Screening for Form 05 began on Feb 3, 2006 when TXR's family met with Dr. Wang, Lynn Wynn, and Susan Strawn to discuss the BABY HUG study. Concurrence with staff that family would be able to participate in the study. Phone service to the home is available.
2. Feb 6, 2006 the family met with the St. Jude ombudsperson, Linda Taylor, who agrees that family understands the study and is able to participate.
3. Feb 9, 2006 the mother signs the informed consent that includes HIPPA



## EXHIBIT 11-8, cont.

authorization.

4. Feb 10, 2006 she completed urinalysis and urine concentrating ability via a bagged specimen. She was NPO for 8 hours prior to her urine collection. Her UA was normal without red or white cells, pH 7.0, negative protein and hemoglobin; specific gravity was 1.008. The biochemistry lab sample was drawn just prior to urine collection.
5. Feb 12, 2006 she completed a TCD by Judy Luden of the Medical College of Georgia.
6. Feb 19, 2006 she was evaluated by Dr. Khan in neurology clinic and completed Bayley's and Vineland neuropsychometric evaluations.
7. Feb 24, 2006 she completed a liver-spleen scan and an abdominal ultrasound. She was NPO for 6 hours prior to her abdominal sonogram. Lab samples sent for DNA and immunology to core laboratories.

Impression: Well appearing toddler with sickle cell disease whose family would like to have their child finally begin taking the study treatment medicine.

Plan:

1. Proceed with BABY HUG randomization after all baseline testing received by the Medical Coordinating Center.
2. Encourage family to call with any questions or concerns.

### Form 31 (Study Visit)

TXR Patient ID number 9x - \_\_\_ \_\_\_ where x – clinic number (e.g., 4 for Clinic 04)  
Clinic Number 99

Week 4

Mar 29, 2006

TXR is a 17-month-old African American female with Hb SS disease, here today for the 4-week study visit of the BABY HUG protocol.

She has been well since her last visit 2 weeks ago without any vaccinations, fevers or hospital admissions. She is currently taking Pen VK 125 mg BID of which her mother reports she missed 1 dose (two days ago) within the past week and that last night's dose was taken. She is taking 2.5 cc of BABY HUG study treatment of which her mother reports she has missed 1 dose because TXR fell asleep before she could give her the dose at bedtime.

On physical examination her temperature was 37.1° C, pulse rate 90/minute, respiratory rate 30/minute, blood pressure 104/64 mmHg, recumbent length 75.5 cm (40<sup>th</sup> %) x 2, weight 12.7 kg (40%) x 2, and HC 49.5 cm, 49.0 cm, 49.5 cm (40%) with no interference in length and HC because of braids. She is playful and well appearing. TMs are clear; oropharynx shows enlarged 3+ tonsils with no exudate or erythema. No palpable lymph nodes. Heart rate is regular with a II/VI systolic ejection murmur. Lungs are clear to auscultation. Abdomen is soft, non-

**EXHIBIT 11-8, cont.**

tender, non-distended, no hepatosplenomegaly. Normal extremities.

Hematology and biochemistry core lab samples not needed today and thus not drawn. Reviewed dosing of study treatment with mother who demonstrates the correct amount being dispensed. Mother returned bottle number 99999997 with approximately 5 cc of study treatment remaining.

Impression: Well appearing toddler participating in the BABY HUG study taking meds fairly well.

Plan:

1. Dispense two-week supply of BABY HUG study treatment, bottle number 88888888 with a daily dose of 2.5 cc (250.0 mg) PO.
2. Discuss with mother the possibility of giving the study treatment dose in the AM to avoid missed doses.

0125	BH: 13959	BH: 13959	BH: 13959	BH: 13959	BH: 13959	BH: 13959
1	BH: BDKFK	BH: BDKFK	BH: BDKFK	BH: BDKFK	BH: BDKFK	BH: BDKFK
0125	BH: 52654	BH: 52654	BH: 52654	BH: 52654	BH: 52654	BH: 52654
2	BH: FCGFE	BH: FCGFE	BH: FCGFE	BH: FCGFE	BH: FCGFE	BH: FCGFE
0125	BH: 09854	BH: 09854	BH: 09854	BH: 09854	BH: 09854	BH: 09854
3	BH: AKJFE	BH: AKJFE	BH: AKJFE	BH: AKJFE	BH: AKJFE	BH: AKJFE
0125	BH: 08253	BH: 08253	BH: 08253	BH: 08253	BH: 08253	BH: 08253
4	BH: AJCFD	BH: AJCFD	BH: AJCFD	BH: AJCFD	BH: AJCFD	BH: AJCFD
0125	BH: 59155	BH: 59155	BH: 59155	BH: 59155	BH: 59155	BH: 59155
5	BH: FKBFF	BH: FKBFF	BH: FKBFF	BH: FKBFF	BH: FKBFF	BH: FKBFF
0125	BH: 51858	BH: 51858	BH: 51858	BH: 51858	BH: 51858	BH: 51858
6	BH: FBJFJ	BH: FBJFJ	BH: FBJFJ	BH: FBJFJ	BH: FBJFJ	BH: FBJFJ
0125	BH: 48653	BH: 48653	BH: 48653	BH: 48653	BH: 48653	BH: 48653
7	BH: EJGFD	BH: EJGFD	BH: EJGFD	BH: EJGFD	BH: EJGFD	BH: EJGFD
0125	BH: 58159	BH: 58159	BH: 58159	BH: 58159	BH: 58159	BH: 58159
8	BH: FJBFK	BH: FJBFK	BH: FJBFK	BH: FJBFK	BH: FJBFK	BH: FJBFK
0125	BH: 29654	BH: 29654	BH: 29654	BH: 29654	BH: 29654	BH: 29654
9	BH: CKGFE	BH: CKGFE	BH: CKGFE	BH: CKGFE	BH: CKGFE	BH: CKGFE
0125	BH: 05451	BH: 05451	BH: 05451	BH: 05451	BH: 05451	BH: 05451
10	BH: AFEFB	BH: AFEFB	BH: AFEFB	BH: AFEFB	BH: AFEFB	BH: AFEFB
0125	BH: 44954	BH: 44954	BH: 44954	BH: 44954	BH: 44954	BH: 44954
11	BH: EEKFE	BH: EEKFE	BH: EEKFE	BH: EEKFE	BH: EEKFE	BH: EEKFE
0125	BH: 23656	BH: 23656	BH: 23656	BH: 23656	BH: 23656	BH: 23656
12	BH: CDGFG	BH: CDGFG	BH: CDGFG	BH: CDGFG	BH: CDGFG	BH: CDGFG
0125	BH: 35157	BH: 35157	BH: 35157	BH: 35157	BH: 35157	BH: 35157
13	BH: DFBFH	BH: DFBFH	BH: DFBFH	BH: DFBFH	BH: DFBFH	BH: DFBFH
0125	BH: 29555	BH: 29555	BH: 29555	BH: 29555	BH: 29555	BH: 29555
14	BH: CKFFF	BH: CKFFF	BH: CKFFF	BH: CKFFF	BH: CKFFF	BH: CKFFF
0125	BH: 24154	BH: 24154	BH: 24154	BH: 24154	BH: 24154	BH: 24154
15	BH: CEBFE	BH: CEBFE	BH: CEBFE	BH: CEBFE	BH: CEBFE	BH: CEBFE
0125	BH: 45353	BH: 45353	BH: 45353	BH: 45353	BH: 45353	BH: 45353
16	BH: EFDFF	BH: EFDFF	BH: EFDFF	BH: EFDFF	BH: EFDFF	BH: EFDFF
0125	BH: 46752	BH: 46752	BH: 46752	BH: 46752	BH: 46752	BH: 46752
17	BH: EGHFC	BH: EGHFC	BH: EGHFC	BH: EGHFC	BH: EGHFC	BH: EGHFC





**EXHIBIT 11-11**  
PEDIATRIC HYDROXYUREA CLINICAL TRIAL  
**REQUEST FOR NEUROLOGIST CERTIFICATION**

BABY HUG Form 126  
Rev 0 09/08/03  
Page 1 of 1

Clinical Center: \_\_\_\_\_ Clinical Center No.: \_\_\_\_

Certification as BABY HUG Neurologist is requested for:

Name: \_\_\_\_\_

The individual named above: (all MUST be checked)

- Is a board certified/eligible pediatric neurologist.
- Has performed the BABY HUG or Pediatric AIDS Clinical Trials Group examination at least once.
- \*  Has completed on paper a Form 43.

\*To be submitted with this form if not previously submitted.

Principal Investigator: \_\_\_\_\_  
Signature Date



EXHIBIT 11-13

Requirements for BABY HUG Individual Certification

<b>Clinical Center</b>	<b>PI</b>	<b>Co-PI</b>	<b>Coord.</b>	<b>PEP</b>	<b>ATRS</b>	<b>Neuro- psychologist</b>	<b>Neurologist</b>	<b>Pharmacist</b>
Date attended a BABY HUG Training Session or trained by a certified staff member								
Successful completion of a BABY HUG general knowledge test								
Certification in Anthropometry								
Submitted a completed BABY HUG website individual application								
Completion & Data Entry of Form 05 (Eligibility Screening II)								
Completion & Data Entry of Form 31( Study Visit)								
Automated Telephone Response System (ATRS) Certified								
Experience with Bayley & Vineland evaluations								
Completion of Form 40 (Bayley) & Form 41(Vineland)								
Board Certified/Eligible Pediatric Neurologist								
Performed the BABY HUG or Pediatric AIDS Clinical Trials Group examination at least once								
Practice with completion of Form 43								
Training on Clinical Center Pharmacy procedures								
Submitted Request for Clinical Center Certification								
Submitted Request for Co-Investigator Certification								
Submitted Request for Clinic Coordinator Certification								
Submitted Request for Neuropsychologist Certification								
Submitted Request for Neurologist Certification								
Submitted Request for PEP Certification								
Financial Disclosure								
Human Subjects Training Certificate								



**PEDIATRIC HYDROXYUREA PHASE III CLINICAL TRIAL (BABY HUG)  
MANUAL OF OPERATIONS**

**CHAPTER 12**

**STUDY MONITORING AND REPORTING RESULTS**

**12.1 INTRODUCTION**

Monitoring and communicating ongoing results in BABY HUG are essential for assuring patient safety and the proper performance of study procedures. Data collected in the Clinical Centers and in the Core Laboratories are under continual review to assure both patient safety and proper performance.

**12.2 MONITORING PATIENT SAFETY**

Assuring patient safety begins with establishing that all data collected in BABY HUG are correctly entered by certified personnel. Any questions concerning these data are directed to the responsible personnel through the edit system or on further review of data in the Medical Coordinating Center (MCC) through contact by telephone, fax or e-mail. In addition, Clinical Center staff take steps to monitor for patient safety.

In the Clinical Centers, any child who appears to be acutely ill on presentation for a clinic visit will be referred for immediate care (see Appendix D). Also, at each clinic visit, children enrolled in BABY HUG will have a complete blood count (CBC) and differential white blood cell count performed with results reported to the Primary Endpoint Person (PEP). The PEP will assure that appropriate clinical intervention is performed in the event that the local CBC and differential indicates an unsafe hematological status (see Sections 5.9 and 6.5). Clinical Center staff monitor for and report serious and other adverse events (see Section 6.6).

In the MCC, Core Laboratory results are monitored by computer and manually by an MCC medical consultant to assure that patients are in satisfactory status on hematology, biochemistry

and immunology evaluations. Severe (alert) abnormalities of the CBC, differential cell count, biochemistry or immunology findings are reported within 24 hours to the PEP.

### 12.2.1 Real Time Complete Blood Counts

1. Each Clinical Center will designate the person (a hematologist, or nurse practitioner or physician's assistant qualified to perform this task relative to state health regulations, who has no other BABY HUG responsibility) who will monitor each child's blood work that is performed locally at each clinic visit (the local CBC monitor).
2. The PEP will data enter the CBCs into the BABY HUG database via the Internet Data Entry System within one day of collecting the specimen or by 9:00 a.m. Eastern time of the following morning.
3. The PEP will keep the local laboratory results in a locked file with no access by BABY HUG staff.
4. The MCC will check any received local laboratory data for violating BABY HUG toxicity and/or alert levels and will send the appropriate messages to the PEP.
5. The designee, if in his/her clinical judgment, believes a toxicity and/or alert level has been crossed, will contact appropriate clinicians to notify them of the toxicity and/or alert and to arrange for appropriate emergency clinical care.

If the absolute neutrophil count (ANC) on the local blood count is below 1250/uL or the Hgb <6.0 g/dl or the Hgb has dropped 20% or more from the 3-month rolling average or the platelet count is <80,000 mm<sup>3</sup>, study treatment should be stopped and the child should be clinically evaluated to determine if intervention is required. BABY HUG study medication should be stopped and the MCC notified. If the ANC on the local blood count exceeds 1,250/uL prior to hospital discharge, BABY HUG study medication should be resumed at the same dose as on admission. If on hospital discharge the ANC on the local blood count is still below 1,250/uL, the patient and

family should be instructed not to resume treatment until a scheduled local blood specimen is above 1250/uL and reviewed in the MCC.

If the absolute neutrophil count on local blood count is between 1,000/uL and 1,250/uL during evaluation for a febrile event, the BABY HUG study medication should be stopped. The patient may be treated as an outpatient or admitted at local option. If admitted, BABY HUG study treatments will be stopped as above. If managed as an outpatient, the patient should remain off BABY HUG study medication until a scheduled blood count is performed locally and reviewed in the MCC.

### **12.2.2 Alert Monitoring Levels**

The PEP will review the local CBC results to determine if a toxicity and/or alert is present in the data. Alert laboratory values (Exhibit 6-3) are indicators to the MCC and the Clinical Center staff that the patient requires clinical follow-up and are distinct from toxicity values (also shown in Exhibit 6–3). Section 6.5.1.2 gives the guidelines for responding to notification of an alert.

### **12.2.3 BABY HUG Adverse Event Reporting**

#### **12.2.3.1 Introduction**

Monitoring for unanticipated adverse clinical effects will be done using event forms. The Clinical Center staff will determine the degree of severity (mild to fatal). Event forms will be submitted to the Medical Coordinating Center (MCC) and tabulated based on the affected organ system. Each serious AE (SAE) will be reported to the MCC within 24 hours of the event; supporting information will be required from the Clinical Center. MCC staff and the central review group will immediately review the report to determine if the event is serious. If so, MCC staff will send the information to the NHLBI and NICHD Project Officers, the FDA, the Executive Secretary of the DSMB, and the DSMB Chair for review. The occurrence of serious AEs will be reported to the Clinical Center IRBs within 24 hours of NHLBI review.

A serious adverse event is any of the following.

1. death
2. a life-threatening event
3. prolonged hospitalization (greater than 7 days)
4. splenic sequestration crisis
5. stroke, TIA
6. acute chest syndrome
7. an ICU admission

Certain Serious Adverse Events that are sickle cell related have been added to the list, as defined by the FDA. Item #3 has been modified from the FDA definition given that frequent hospitalizations occur as a consequence of having sickle cell anemia without being enrolled in a clinical trial. Any serious adverse events (as defined by the FDA) which are not included in the above list, will be summarized and reported semi-annually. The Clinical Centers will be required to provide supporting information using a MedWatch Form 3500A (exhibit 6-4) for the events in the above list.

In addition to this reporting mechanism, a centralized over-ride system will be carried out by individuals with knowledge about the treatment assignments. These individuals will review adverse events that are not thought to be serious in the eyes of the blinded investigators and make decisions about whether an adverse event is “serious” and reportable to the FDA. The two central review individuals will be the NHLBI Project Officer and MCC Medical Consultant. Either of these individuals will have the ability to elevate an adverse event being reported to the MCC to the “serious” category which will precipitate the collection of the required information for the MedWatch Form 3500A and a subsequent report to the FDA.

Adverse events and serious adverse events will be listed individually and according to body system, designated according to severity (mild, moderate, severe, life-threatening, or fatal) and

likelihood of relation to study treatment (not related, possibly, probably or definitely related), and classified and according to outcome (significant new disability, persistent new disability, permanent new disability, or death).

#### **12.2.3.2 DBDR Adverse Event Coverage**

NHLBI Division of Blood Diseases and Resources (DBDR) staff will examine all adverse event reports from BABY HUG in real time and discuss with the BABY HUG Operations Committee appropriate clinical management. NHLBI - DBDR will hold emergency meetings to review adverse event reports as they occur. These DBDR staff will alternate night and week-end coverage via cell-phone so that the BABY HUG MCC will have access to a DBDR staff person at all times to discuss the management of adverse events in BABY HUG subjects.

#### **12.2.3.3 Elevated Adverse Event Rate Detection**

Events to be centrally reviewed include all serious adverse events (i.e., death, events that are life-threatening, events that cause or prolong hospitalization (greater than 7 days), splenic sequestration crisis, acute chest syndrome, stroke, transient ischemic attacks and ICU admissions). Other clinical occurrences will be denoted as having occurred or not occurred on clinic visit reports. There is adequate statistical power in BABY HUG to detect 50% differences between treatment groups at  $\alpha = 0.01$  if the event rates are in the range expected from the Cooperative Study of Sickle Cell Disease (CSSCD) and the study is completed with 200 patients. The BABY HUG investigators do not plan for early termination based on clinical events other than demonstrated inferiority of hydroxyurea for the outcomes death, stroke or splenic sequestration.

The most important clinical events other than death and stroke are acute chest syndrome (ACS) and splenic sequestration (defined in Protocol Appendix F). Each child will be clinically evaluated repeatedly to determine if he/she has had acute chest syndrome, splenic sequestration or a serious, unexpected adverse event in the course of the study period. The proportion of very young children experiencing these adverse events will be compared according to assigned

treatment. A one-sided test-based confidence interval ( $\alpha = 0.005$ ) will be used to determine if very young children treated with HU have significantly higher frequencies than very young children treated with placebo. If the test-based, one-sided confidence interval does not cover zero, the DSMB will consider all relevant information for the study and may recommend that the clinical trial not continue and HU not be recommended as a treatment for very young children.

#### **12.2.3.4 Interim Reports**

Adverse events used to evaluate the safety of the BABY HUG regimen will be collected to include any unfavorable and unanticipated signs (including abnormal laboratory findings), symptoms or diseases (i.e. incidence of stroke, renal failure, regimen related toxicities, or infectious complications), which either occur during the study, having been absent at baseline or if present at baseline, appear to worsen and are determined to be possibly, probably or definitely related to this investigational treatment.

Although the size of the Feasibility and Safety Pilot Study was chosen to allow the BABY HUG investigators to evaluate several administrative issues of the overall study design, it will be important to monitor the study in an ongoing fashion with respect to performance criteria and the occurrence of adverse events. For analyses other than those discussed above, we will protect our findings against finding spurious associations due to the large number of repeated tests of significance that will be performed. To do this, we will use monitoring bounds (for HU versus control comparisons) of 0.01 rather than 0.05 for the safety and adverse event evaluations listed below. We will use the following monitoring.

#### Monitoring Safety and Adverse Events

The DSMB Chair, Executive Secretary of DSMB and NHLBI and NICHD Project Officers will review monthly reports including:

1. Recruitment: Expected vs. Actual
2. Patients screened, eligible and randomized

3. Patient characteristics at baseline
  - A. Spleen size
  - B. Pitted cell counts
  - C. Urine concentrating ability
  - D. CBC and reticulocyte count
  - E. Presence of gallstones
  - F. Blood chemistries
  - G. Microalbuminuria
  - H. O<sub>2</sub> saturation
  - I. Physical examinations
  - J. Neurological examination and neuropsychological development
  - K. Height, weight, head circumference
  - L. Transcranial doppler (TCD) measurements
4. Blood count toxicities
5. Dose adjustments
6. Intra- and Inter-observer agreement on liver-spleen scans
7. Immunological Impairment
8. Safety assessments and adverse events
  - A. Height, weight, head circumference
  - B. Neurological examination and neuropsychological development
  - C. Unexpected and serious adverse events: update tallies, rates and individual summaries (case reports) for immediate review by the Executive Secretary of the DSMB, DSMB Chair and NHLBI and NICHD Project Officers

### Individual Patient and Group Safety Monitoring

1. In consultation with the Project Officers, the Executive Secretary of DSMB, and the DSMB chair may recommend full DSMB review or individual treatment interruptions.
2. All individuals whose treatment is interrupted or stopped will continue to be monitored.

#### **12.2.3.5 Analysis of Death or Stroke**

Death and clinically manifest stroke represent the most adverse outcomes that can occur within this study, and it will be important to determine if HU treatment results in an excess number of these types of events. These two outcomes will be evaluated separately from each other. One-sided test-based confidence intervals ( $\alpha = 0.05$ ) will be used to determine if very young children treated with HU have a significantly higher frequency of either outcome than very young children treated with placebo. If the 95% one-sided confidence interval for either stroke or death does not cover 0, it may be recommended that the trial not proceed and that HU not be used as a treatment for very young children.

Clinical Centers will be expected to report to the MCC the occurrence of death or stroke within 24 hours of learning about the event. The MCC will prepare a report immediately with the information at hand for the NHLBI and NICHD Project Officers, Executive Secretary of DSMB and the DSMB Chair. Within 10 days, the Medical Coordinating Center staff will provide an updated report for the Project Officers, DSMB Executive Secretary, and for the DSMB Chair. Each case will be reviewed individually with the DSMB. The NHLBI Project Officer and DSMB Executive Secretary will file reports on each death or stroke with the U.S. FDA under the study IND. If the p-value for an association of death or of stroke with hydroxyurea is between 0.05 and 0.20 after any occurrence, the members of the DSMB will review all death or stroke reports in BABY HUG in aggregate and with other study data to consider whether or not there is a concern that should be addressed with a Protocol revision or study termination.



### 12.2.3.6 Analysis of Growth and Development

We will analyze each child's weight (monthly), height (quarterly), head circumference (quarterly), and growth velocity (monthly). We will measure their neurodevelopment (Bayley, Vineland) annually. Height, weight and head circumference growth will be analyzed using actual measurements and percentiles standardized to the CSSCD population of children with HbSS for height and weight, and to a normal black American population for head circumference (Pivnick et al, 1999). Average scores for the two treatment groups will be compared to test:

$$H_0: \mu_2 > \mu_1$$

versus the alternative:

$$H_A: \mu_2 \leq \mu_1,$$

where  $\mu_2$  is the mean of measurements or percentiles for children assigned to HU and  $\mu_1$  is the mean of measurements or percentiles for children assigned to placebo.

Each test will be a t-test performed on the estimates of height, weight and head circumference calculated for each child. It is proposed that DSMB members review individual growth and height for possible clinical indications of adverse effects of HU on height and weight if the mean in HU-treated very young children is between 1 and 2 standard deviations (SD) below the mean for placebo-treated very young children and to stop the study if the mean of HU-treated very young children is more than 2 SDs below placebo treated very young children.

For review, DSMB members will be provided with the growth curves of each child printed on paper with percentiles from the CSSCD and specifying treatment assignment, and a graph of the average growth velocity over three month intervals according to time from study entry and treatment. Growth will be analyzed with cubic models (mixed model analysis of variance to incorporate child-specific random effects, and in treatment group comparisons to account for correlation of serial measurements) fit to each child. Growth velocity will be estimated with the first

derivative with respect to time of the cubic models. Curves will be plotted as each child's percentiles for growth over time also.

Neuro-development questionnaires will be administered annually. For the evaluation of this endpoint, we will compare the one-year cognitive function between toddlers treated with HU and toddlers treated with placebo.

If a test-based, one-sided 99% confidence interval of the difference in mean Bayley score at one-year does not cover zero, it may be recommended that the trial not continue and that HU not be used as a treatment for very young children.

#### **12.2.3.7 Analysis of Acute Chest Syndrome, Splenic Sequestration and Serious, Unexpected Adverse Events**

The most important clinical events other than death and stroke are acute chest syndrome (ACS) and splenic sequestration (as defined in Protocol Appendix F). Each very young child will be clinically evaluated repeatedly to determine if he/she has had acute chest syndrome, splenic sequestration or a serious, unexpected adverse event in the course of the two-year follow-up period. The proportion of very young children experiencing these adverse events will be compared according to assigned treatment. A one-sided test-based confidence interval ( $\alpha = 0.005$ ) will be used to determine if very young children treated with HU have significantly higher frequencies than very young children treated with placebo.

On a daily basis, the MCC staff check the data entry system for new Clinical Event Forms (BABY HUG Form 50). The dedicated BABY HUG fax machine is continually checked for new transmissions of BABY HUG Form 50. On the same day as received, these documents and corresponding laboratory results are sent to the MCC Medical Consultant.

Reports of adverse events are tabulated weekly in reports to the Operations Committee and to the Steering Committee.

### **12.3 MONITORING DATA QUALITY**

The Internet Data Entry System monitors for data errors (e.g., MAT instead of MAY) at the time of data entry. The Internet Data Entry system also edit forms entered upon direction by Clinical Center staff. These edits give feedback to Clinical Center staff on missing items and inconsistent items, including longitudinal edits on growth measurements.

On a quarterly basis, the Clinical Center Quarterly Performance Report is provided to all Clinical Centers. This report provides information on forms entered, edited and passing edit; central laboratory specimens received and reported on; as well as, special study procedures performed and readings completed.

### **12.4 MONITORING SPECIMEN AND FILM QUALITY**

On a continual basis, all specimens received in the Core Laboratories are inspected for conditions on arrival and labeling with comparison to transmittal lists included in shipments and entered on the Internet Data Entry system. Inconsistencies in labeling and problems with specimen condition (e.g., cracked tubes, clotted CBC specimens, insufficient quantities) are communicated to the Clinical Center staff within 24 hours of report to the MCC.

Liver-spleen scan and abdominal sonogram films are examined for adequacy by the central readers. Films judged to be inadequate for reading are returned to the Clinical Center for reprocessing, if possible.

### **12.5 INSTITUTIONAL DATA AND SAFETY MONITORING AND REPORTING**

The safety of interventions and treatments associated with the Protocol will be under continual review by the MCC, NHLBI, NICHD and DSMB. Accrual, efficacy and safety data will be monitored by all four groups.

Accrual and safety data will be reviewed annually by each Clinical Center's IRB. Prior to implementation of this study, the Protocol and the proposed patient consent forms will be reviewed and approved by the properly constituted IRB operating according to the 45 CFR 46 code of federal

regulations. This committee will also approve all amendments to the Protocol or informed consent, and conduct continuing annual review so long as BABY HUG is open to accrual or follow-up of subjects.

A Data and Safety Monitoring Report is prepared monthly for the NHLBI for distribution to the DSMB. This report does not separate treatment groups, but does include information on recruitment, forms received and delinquent, study specimens collected and delinquent, study procedures performed and delinquent, adverse events, enrolled children's height, weight and head circumference, physical examination of the liver and spleen, results of blood specimen analyses, changes in study treatments and Protocol violations.

Every six months, a complete report of all data (except primary endpoint data) in BABY HUG, comparing treatment groups, is provided to the DSMB. A progress report will be forwarded to the DSMB at these times and their recommendations will be expeditiously implemented. The DSMB may recommend early termination of the study for considerations of safety or efficacy.

**PEDIATRIC HYDROXYUREA PHASE III CLINICAL TRIAL (BABY HUG)  
MANUAL OF OPERATIONS**

**CHAPTER 13**

**MEDICAL COORDINATING CENTER PROCEDURES**

**13.1 INTRODUCTION**

The Medical Coordinating Center (MCC) is organized and staffed as part of Clinical Trials & Surveys Corp. (C-TASC) to serve the needs of BABY HUG. The MCC staff fulfill key roles in developing and implementing the study's statistical design, data collection and management, and analysis of study results. The major responsibilities of the MCC, which serves as the central data repository for the information collected under the common study protocol, are: (1) serve as communication center for the study; (2) provide the Internet data entry system for all study data; (3) maintain a central database of data integrated from all Clinical Centers, Core Laboratories and central reviewers; and (4) generate analyses to monitor for evidence of adverse or beneficial treatment effects, safety monitoring and adherence to the study protocol. The objectives and procedures designed to achieve these obligations are presented in this chapter.

**13.2 OBJECTIVES OF THE MEDICAL COORDINATING CENTER**

The general aims of the BABY HUG MCC are to:

- Serve as a collaborating partner with the other investigators in the organization, design, conduct, and analysis of the study.
- Provide biostatistical expertise to the study in the area of design and operation of this multicenter study.
- Work with the other investigators and consultants to draft and revise as necessary the Protocol, Manual of Operations, and study forms.
- Develop and implement the study treatment randomization schedule.
- Assist the NHLBI in obtaining and maintaining an Investigational New Drug (IND) application with the FDA for hydroxyurea usage in young children.

- Provide expertise in the area of Internet data entry and statistical analysis.
- Develop and implement the required data processing procedures for handling all study forms, core laboratory results and other materials.
- Develop, implement and maintain quality control procedures to detect and correct deficiencies in data collection, processing or analyses.
- Provide facilities and staff to carry out appropriate analyses to monitor the study for evidence of adverse or beneficial treatment effects.
- Establish and maintain subcontracts with Core Laboratories and medical consultants as needed by the study.
- Serve as the communication center for the study.
- Prepare progress reports and assist in preparation of publications.

### **13.3 PLANNING, TRAINING AND MEETING SUPPORT**

The members of the BABY HUG MCC play a major role in the organization and conduct of investigator meetings, subcommittee meetings, and conference calls held during all phases of the study. The BABY HUG MCC staff provide training to BABY HUG Clinical Center staff in the collection and processing of data, as necessary. In addition, the BABY HUG MCC staff provide logistical support for orientation and training sessions.

### **13.4 STUDY DOCUMENTS AND SUPPLIES**

MCC staff are responsible for the coordination of the preparation of Protocol and Manual of Operations. MCC staff and the Principal Investigators will collaborate in the development and finalization of these documents. During participant recruitment and follow-up, it is anticipated that a number of aspects of the protocol will require clarification, certain procedures will require revision as a result of the Clinical Center experience, and specifications for other procedures will require development. BABY HUG MCC staff periodically will review current procedures and develop additional procedures as needed throughout the course of the study.

The BABY HUG Manual of Operations provides a detailed description of study design, organization, methods, definitions, and procedures used in data collection and processing. This Manual will be revised as necessary during the course of the study.

The MCC staff, in conjunction with the Principal Investigators, develop the data collection forms. The MCC staff prepare all BABY HUG forms and corresponding QxQ's. All forms changes will also be prepared by the MCC.

MCC staff will assist the National Heart, Lung, and Blood Institute staff in obtaining and maintaining an Investigational New Drug (IND) application to the Federal Drug Agency (FDA) for hydroxyurea in this age group of children.

MCC supplies each Clinical Center with study notebooks containing the Protocol, Manual of Operations, Forms and QxQ's, and Address Directory. Updates will be sent as needed; the MCC posts the most recent version of these documents on the BABY HUG website.

The MCC staff prepare and supply all BABY HUG customized supplies (e.g. patient specimen and film labels, FedEx preprinted shipping labels, study participant cards, etc.). The MCC also provides the Clinical Centers with neuropsychological testing materials, sample notebooks for filing patient study documentation and materials, and contact information cards.

### **13.5 CLINICAL CENTER COMMUNICATIONS**

The MCC serves as the communication center for the study.

The MCC staff are a resource for the numerous telephone inquires and written inquiries concerning the study procedures from study investigators and Clinical Center personnel.

The MCC issues numbered memoranda to Principal Investigators and/or coordinators to impart study-wide policies, procedures, announcements, operational issues, etc., and to request information.

The MCC staff provide logistical support for meetings, conference calls and training sessions. They are responsible for preparing handouts and other materials for meeting participants as well as for preparing and distributing the minutes of these meetings.

MCC staff maintain and distribute a BABY HUG Address Directory. This directory contains a listing of study personnel from each Clinical Center, each Core Laboratory, all study consultants as well as personnel from the Program Offices at the NHLBI and NICHD and the Medical Coordinating Center. This directory is updated periodically and revised pages are distributed to all centers.

The MCC staff notify the Clinical Center staff of a treatment stop order, if necessary, within 48 hours of a study visit. The MCC staff also issue treatment dose recommendations to the Clinical Center staff based on recommendations of an MCC Medical Consultant.

## **13.6 CLINICAL CENTER MONITORING**

### **13.6.1 Protocol Violations and Deviations**

MCC staff are responsible for monitoring for protocol deviations and for notifying all appropriate BABY HUG personnel or appropriate committees of any deviations when the MCC becomes aware of them (e.g., not executing a stop order, prescribing a dose higher than 20 mg/kg, taking only one O<sub>2</sub> saturation measurement, not obtaining two height measurements within the required tolerance limits).

### **13.6.2 Weekly Recruitment Reports**

Weekly reports on the status of recruitment are prepared by the MCC staff and circulated to the BABY HUG Principal Investigators. These reports include the number of patients enrolled to date, the number of patients deemed ineligible, and the number of patients who have started treatment.



### **13.6.3 Performance Reports**

Performance reports are prepared by the MCC staff and distributed to the Clinical Centers quarterly. These reports include information on forms entered, edited and printed; special study procedures performed; laboratory specimens collected; and protocol deviations.

### **13.7 TREATMENT RANDOMIZATION AND ALLOCATIONS**

The MCC staff developed a system, the Automated Telephone Response System (ATRS), for random assignment of study treatment group for each patient enrolled in the trial. Separate randomization schedules were generated for each Clinical Center. Each schedule is designed to balance the number of patients assigned to the treatment groups in the study. The ATRS will communicate the random assignments to the individual Clinical Centers. The BABY HUG computer system will receive randomization and enrollment information via the ATRS.

### **13.8 DATA COLLECTION AND STORAGE**

The BABY HUG Manual of Operations provides a description of study design, organization, methods, definitions, and procedures used in data collection. The MCC staff in conjunction with appropriate BABY HUG investigators coordinate the preparation of this document.

#### **13.8.1 Data from the Clinical Centers**

The MCC programming staff are responsible for developing an Internet Data Entry System. Clinical Center staff submit data from screening and routine study visits into the BABY HUG database via the Internet Data Entry System. Data must be entered into the database within specified time frames before being declared delinquent or missing.

#### **13.8.2 Data from the Core Laboratories**

Specimens are sent directly to the Hematology, Biochemistry, Cytogenetics, Immunology, Pitted Cell and DNA Core Laboratories from the Clinical Centers. Specimen transmittal information is contained in forms entered into the BABY HUG database via the Internet Data Entry System. All Core Laboratory data are transmitted electronically to the MCC. The MCC programming staff

are responsible for developing and implementing the procedures to receive and store the data from the Core Laboratories. A regular schedule for transmission of these data is established.

### **13.8.3 Data from Central Readers**

All film images are sent to the Medical Coordinating Center from the Clinical Centers, and film transmittal information is contained in forms entered into the BABY HUG database via the Internet Data Entry System. MCC staff send the films to the respective central readers who complete the appropriate reading form, send the form and the films back to the MCC. MCC staff enter the data into the BABY HUG database via the Internet Data Entry System. The films are stored in a secure location at the MCC.

### **13.8.4 Data from Clinical Events Reviewers**

MCC coordination staff have responsibility for handling the materials for medical contacts documentation required by the Clinical Events Classification Committee. This involves photocopying the forms and all accompanying materials, completing the initial portion of the classification form, monitoring the return of the forms, and entering the data into the BABY HUG database via the Internet Data Entry System.

### **13.8.5 Storage System for Study Documents**

All important study documents are posted on the BABY HUG website which is updated regularly. This includes study reports, minutes of meetings and conference calls, and the Protocol and Manual of Operations.

## **13.9 DATA MANAGEMENT AND MAINTENANCE**

The MCC data management staff have designed and implemented the Internet Data Entry System to be used in the Clinical Centers. The Clinical Center staff are responsible for data entry, data editing, and corrections, if necessary, of all study forms. These procedures are described in Chapter 10. The MCC staff are responsible storing and analyzing all received study data.

### **13.9.1 Form Data**

Forms are edited for acceptable codes, valid ranges and logical consistency by electronic checks during data entry at the Clinical Center. A form is submitted to the MCC only after it has been saved.

When Clinical Center staff request a form edit, the Internet Data Entry System edits the study data for completeness, consistency with previous and concurrent data from the same patient, and numerical values outside of specified limits. If appropriate, edit queries for a given form are generated and can be printed by Clinical Center staff. Clinical Center staff correct the forms using screen images of the data form. Additional information on these procedures is given in Chapter 10.

All corrections made are electronically audited. The audit file includes the old and new values for the field, date of the correction and who made the correction. The form is automatically marked as corrected as soon as responses to edits have been made and accepted.

### **13.9.2 Core Laboratory Results**

Results from core laboratories are checked for acceptable codes and valid ranges. Data outside the ranges are not imported into the database until verified.

## **13.10 DATA ANALYSES AND REPORTS**

Details of the data analysis plan are contained in the BABY HUG Statistical Analysis Plan. Monthly reports to the NHLBI and semi-annual reports (or others, as needed) for the Data Safety and Monitoring Board are based on the Statistical Analyses Plan. In addition, baseline data reports are made available to the Steering Committee three times a year.

## **13.11 DATA PUBLICATION AND REPORTING**

MCC staff will assist, if requested, the participating Clinical Center staff in the preparation of publications which have received prior approval according to study procedures (see Chapter 16).

Upon request of the National Institutes of Health (NIH) any and all of the above data are made available to the NIH to access and utilize at any time after the completion of the BABY HUG

study. At that time any and all data requested by the NIH are transferred to the National Heart, Lung, and Blood Institute (NHLBI).

### **13.12 PATIENT PRIVACY, CONFIDENTIALITY OF DATA, AND DATA SECURITY**

Because of the importance of protecting study data at the MCC from theft or unauthorized perusal or alteration, access to computer files is restricted through the use of assigned individual usernames and passwords. Protection of the computer files from catastrophic loss is accomplished by a backup system.

To maintain patient privacy, the study records submitted to the MCC do not contain participants' names, addresses or other identifying information. Each participant record is identified by a unique four-digit Patient ID Number and a three-character Patient Letter Code. Names and addresses corresponding to the identifying codes are kept on file at the Clinical Center on a special form (BABY HUG Form 01A, Patient Information).

MCC staff utilize a variety of safeguards to protect the study from catastrophic loss of data. The BABY HUG database is archived on a daily basis. Other files including programs used for all data management functions are fully archived once every week with an "incremental" back-up daily. An incremental back-up is one in which only files that have been modified are archived. The back-up system is designed to permit the restoration of the system with a minimum expenditure of time and money should any file be destroyed by a man-made or natural disaster. Prior to any major change in the operating system, back-up tapes of the main database are created and saved for a minimum of six months.

Copies of analysis files and programs used in the preparation of scientific presentations and publications are retained for the duration of the contract and stored off site. The analysis files include the programs and procedures that are utilized to extract the data from the database.

### **13.13 QUALITY CONTROL**

#### **13.13.1 Certification**

The MCC staff has developed, implemented and monitored the BABY HUG staff certification program outlined in Chapter 11, with specific MCC responsibilities outlined in Section 11.5. The MCC staff maintain a roster of certified staff for each Clinical Center.

### **13.13.2 Quality Assurance of Clinical Center Data**

Clinical Center personnel are trained during Training Sessions or are instructed by a certified staff member on the BABY HUG Internet Data Entry System. As part of the certification process, they enter the data for selected forms (see Chapter 11), using a standard patient narrative provided by the MCC. The data records from these forms are compared to the master file at the MCC and discrepancies noted.

Before a patient is randomized, Clinical Center staff must confirm on the ATRS the age, gender, and consent approval as entered into the database via Form 04 (Eligibility Screening I). The randomization is conducted only after the data are confirmed.

### **13.13.3 Quality Assurance of Information Stored in Computer Database**

All forms are extensively edited during data entry and after a form edit request is made by Clinical Center staff. To test edit programs, a mock set of study forms which contain errors and inconsistencies are used. The edit program is also run on a few forms received from the Clinical Centers and the edit output is carefully checked. If that test indicates no problem, the edit program becomes part of the usual maintenance procedure, but the edit output continues to be checked for a period of time before deciding the program has been adequately tested.

### **13.13.4 Performance Reports**

Performance of the Clinical Centers with respect to recruitment is assessed in weekly reports. These reports include the number of patients enrolled to date and the number who should have been enrolled to date given the scheduled recruitment period already completed. Performance in other areas are assessed by consideration of the following at quarterly intervals:

1. Number of study forms for which the data are past due, based on each patient's routine study visit date.

2. Number of study forms that have been edited, passed edit and printed.
3. Number of study visits that have been completed during the ideal or extended window, or missed.

The MCC staff compare performance and quality of submitted materials for items such as forms past due, studies not performed, or labs not collected, etc. among Clinical Centers.

#### **13.13.5 Site (or Audit) Visits**

In addition to preparing the Clinical Center performance monitoring reports, the MCC staff insure data quality by conducting periodic site visits (or audit visits) to the Clinical Centers. The data on patient medical records and study index forms are compared against listings of data residing on the BABY HUG database for selected forms as of the date of the request for a site visit. Using the data as of the site visit request should prevent any audit-prompted revisions of the data form(s). Recertification of Clinical Center personnel responsible for key areas of data collection may also be performed during site visits.

Each BABY HUG Clinical Center and the Medical Coordinating Center will be site visited at least once during the study. The Site Visit Team will include the NHLBI Project Officer and/or other designated staff, MCC staff, and for some visits the NHLBI Contract Officer.

During the site visits, the team will conduct an audit of the accuracy of data reported from the medical record for a random sample of cases. The consent forms will be reviewed. The Clinical Center staff will be notified prior to the visit what information should be available. Differences between the study form index documents and the database will be brought to the attention of the Clinical Center staff and resolved. The results of the audit (Site Visit reports) will be submitted to the Principal Investigator of the Clinical Center, the Operations Committee and the Data and Safety Monitoring Board.

#### **13.13.6 Quality Control of the Medical Coordinating Center**

MCC staff perform the following activities to insure the quality of the data and analyses.

1. Persons (such as the coordinator) not involved in the development of the data management system complete a few study data forms, making deliberate errors. These forms are keyed and processed through the data editing system to see if all of the errors are detected by the Internet Data Entry System.
2. For each continuous variable on the database, a point frequency distribution (i.e., a tabulation of the frequency of occurrence of every distinct value) is obtained. This helps to identify many types of abnormalities in continuous data such as: (a) digit preferences; (b) bi-modality or other distinctive shapes of the distribution; and (c) outliers (i.e., extreme values distinctly separate from the rest of the distribution). Once an observation is identified as an outlier, the first step is to go back to the original records and determine whether a recording or keying error was made. If such a value has been verified as correct, MCC staff inquire as to the reasons an outlier exists. The question of whether or not to include the value in the data analysis depends upon the nature of the analysis. There is no reason to exclude the value if the analysis is a count of the number of participants having a value exceeding a given cut-point. However, if measures of central tendency and variability are being computed, or if correlation or regression analyses are being carried out, non-parametric statistics may be preferable.
3. New analysis programs (including those that utilize standard statistical packages such as SAS) are tested by running these programs on a small subfile of 10 or 20 participants and independently reproducing the tabulations and statistical calculations from the original data. These procedures help to assure that the correct variables have been selected from the analysis file, the variables and cut-points have been defined properly, and that transformations of the original variables on the analysis file have been formulated correctly.

#### **13.14 MEDICAL COORDINATING CENTER CONTACTS**

MCC staff serve as a resource for all BABY HUG Clinical Center staff and Core Laboratory staff. Questions concerning the Protocol, study procedures, form entry or other study issues may be directed to appropriate MCC staff (Principal Investigator, Study Manager, Coordinator or Data Management staff). Names and telephone numbers of current MCC staff are given in the BABY HUG Address Directory.



# **PEDIATRIC HYDROXYUREA PHASE III CLINICAL TRIAL (BABY HUG) PROTOCOL MANUAL OF OPERATIONS**

## **CHAPTER 14**

### **CLOSE-OUT PROCEDURES**

#### **14.1 STUDY TREATMENT DISCONTINUATION, MONITORING AND UNBLINDING**

Treatment will be discontinued after 24 months of randomized study treatment in all individual patients. Form 36 (End of Randomized Study Treatment) will be completed for every patient. Collect all blood and perform all special studies as indicated on the study form. If a patient exits from the study prior to completing 24 months of study treatment, Form 36 must still be completed and all attempts should be made to collect all blood and perform all special study tests.

Patients will continue to receive their medical care by their providers and will continue to be observed for study evaluations. Neither blinded study treatment nor open label hydroxyurea will be provided by BABY HUG for enrolled patients after completion of study treatment.

Families of patients who have completed study treatment will be asked to return for follow up observation for up to 5 years after completion. The patients must be re-consented for follow-up observation.

#### **14.2 FAMILY DEBRIEFING**

After the last enrolled patient has completed study treatment the families of all study patients will be provided information regarding the study assignment. Findings of the study as they become available and as determined by the Steering Committee, the Data Safety Monitoring Board and the National Heart, Lung and Blood Institute (NHLBI) will be shared with the families. Any recommendations by the BABY HUG investigators will also be shared with the families.

In a second debriefing the families will be informed of the results of long-term follow-up and the recommendations of the BABY HUG investigators.

### **14.3 DATA CLEAN UP, CLOSURE AND STORAGE**

Clinical Centers will address all data queries from the Medical Coordinating Center (MCC) for data clean up including resolution of forms/procedures expected but not completed. Completed data and resolution of all queries is expected within 2 months of the last patient visit.

Archival of central source data, including Core laboratory results, will be consistent with the requirements for a study conducted under an Investigational New Drug (IND) Exemption and sponsored by the NHLBI.

Storage of frozen and preserved specimens will be maintained according to the requirements of NHLBI subcontracts. MCC will archive study data in accordance with FDA guidance and NHLBI requirements.

Public data files will be made available according to the NHLBI policy. The NHLBI will finalize the disposition of the IND report(s) according to the agreement with the FDA under the IND.

### **14.4 FINAL STUDY DATA AND DISSEMINATION OF RESULTS**

Data processing and final data analysis will proceed on a “time-of-the-essence” basis. The DSMB will review the final data including the specified analysis for efficacy and safety at a planned final meeting. A final, consensus recommendation from the DSMB, Steering Committee, NHLBI and NICHD will be shared with the study patients’ families first. This recommendation will be made public as soon as possible thereafter.

**PEDIATRIC HYDROXYUREA PHASE III CLINICAL TRIAL (BABY HUG)  
MANUAL OF OPERATIONS**

**CHAPTER 15**

**ORGANIZATIONAL STRUCTURE AND PARTICIPATING UNITS**

**15.1 INTRODUCTION**

The Pediatric Hydroxyurea Clinical Trial (BABY HUG) will be conducted in fourteen Clinical Centers, a Medical Coordinating Center and central laboratories. The Clinical Center staff will be trained in accordance with the procedures set out in the study Manual of Operations. The objective is to standardize all study procedures carried out in the Clinical Centers and at the operational central units.

Study monitoring will be carried out by the Data and Safety Monitoring Board (DSMB), Steering Committee and Operations Committee. Monitoring will include adherence to protocol, achievement of recruitment goals, patient safety and efficacy of treatment.

Outcome reviewers in the specialties of neurology, neuroradiology, neuropsychology, nuclear medicine and pediatric hematology will evaluate imaging studies and reports of possible outcome events as members of an Endpoints Evaluation Committee to ascertain selected components of the primary and secondary study endpoints. The Steering Committee will review and approve or disapprove Operations Committee recommendations on proposals for secondary analyses and ancillary studies.

An organizational chart for BABY HUG is presented in Exhibit 15-1.

**15.2 PARTICIPATING UNITS**

**15.2.1 Operations Committee**

The Operations Committee will comprise the Study Chairman, the Vice-Chairman, the Principal Investigator of the Medical Coordinating Center, the NHLBI and NICHD Project Officers, two Clinical Center Principal Investigators (rotating every six months), the Coordinator Chair, two

Clinical Center Coordinators (by election) and, ex officio, the directors of the Pharmacy Distribution Center and of the Core Laboratories, and the Medical Coordinating Center Deputy Director.

The Operations Committee will maintain close ties with the Clinical Centers. The Operations Committee will provide technical and scientific guidance in developing the Protocol and Manual of Operations, study forms, Clinical Center procedures, quality control systems, study treatment titration and distribution procedures, and laboratory specimens preparation and processing. The Operations Committee will implement study procedures to address protocol violations. The Operations Committee will help prepare agendas and contents of reports for Steering Committee meetings.

In addition, the Operations Committee receives and reviews all scientific proposals for use of study data, including ancillary studies. Their considerations in evaluating proposals will include scientific merit, feasibility and resource availability, including statistical, computing and technical support. No ancillary study will be approved which interferes with the conduct of the overall study or is not approved by the Steering Committee and Data and Safety Monitoring Board.

### **15.2.2 Clinical Centers**

The collaborating centers are funded by contracts from the NHLBI. At a minimum, each will have a Principal Investigator, a coordinator, and a Primary Endpoint Person. Exhibit 15-2 lists the Clinical Centers and the Principal Investigator.

A final recruitment report specifying the number of patients enrolled by each certified Clinical Center will be distributed after the end of enrollment.

### **15.2.3 Study Coordinator Committee**

One BABY HUG study coordinator (Coordinator Chair) will be selected to have responsibility for organizing all the BABY HUG study coordinators into the Study Coordinators Committee - SCC.

This person's responsibility will include:

1. foster enthusiasm for the BABY HUG project;
2. act as a liaison between the Steering Committee and the SCC;

3. coordinate regular SCC conference calls; and
4. organize SCC meeting agenda and SCC project reports.

The SCC's responsibility will include:

1. development of coordinator writing projects;
2. attending Steering Committee meetings; and
3. participating in SCC conference calls to
  - a. report enrollment progress,
  - b. collaborate on enrollment successes/problems,
  - c. discuss adherence strategies,
  - d. team build, and
  - e. develop writing plans.

#### **15.2.4 Core Laboratories**

The Core Laboratories have responsibility for receiving blood samples from the Clinical Centers and performing specimen analyses as required for monitoring effects of hydroxyurea. Effects on blood counts will be used to titrate study drug dosages. In addition, the Core Laboratories will perform other analyses such as analyses for fetal hemoglobin and chromosome breakage.

#### **15.2.5 Pharmacy Distribution Center and Investigational Pharmacies**

The study treatments (hydroxyurea and placebo) for BABY HUG will be distributed to Clinical Center Investigational Pharmacies by the Pharmacy Distribution Center. Clinical Center Investigational Pharmacies will maintain records of all patient prescriptions and dosages dispensed for each patient visit.

#### **15.2.6 National Heart, Lung, and Blood Institute**

The National Heart, Lung, and Blood Institute (NHLBI) staff -- Office of Blood Diseases Program (Division of Blood Disease and Resources) and Office of Biostatistics Research (Division of Epidemiology and Clinical Applications) will participate with study investigators and key study personnel in all phases of the study. A member of the Blood Diseases Program (Division of Blood Diseases and Resources) will serve as a voting member on the Steering Committee, and other

study committees as appropriate. NHLBI staff on the Steering Committee will participate throughout the phases of Protocol development, recruitment, follow-up, data analysis and interpretation.

The NHLBI staff will address issues concerning recruitment, treatment, follow-up, quality control, and adherence to Protocol to assist the study investigators in assessing potential problems affecting the study and potential changes in the Protocol. They will provide direction in the management of the contracts which fund the study, and assistance in developing solutions to major problems such as insufficient participant enrollment. A Data and Safety Monitoring Board has been appointed by the NHLBI to provide overall monitoring of the study.

#### **15.2.7 Medical Coordinating Center**

The Medical Coordinating Center staff will include the Principal Investigator/Medical Coordinating Center Director, Project Manager/Deputy Director, statistician(s), computer programmer(s) and coordinator(s). Medical Coordinating Center staff for BABY HUG will provide expertise in the areas of study design, quality control, data processing and data analysis. Medical Coordinating Center staff will provide biostatistical and epidemiological advice for the overall conduct of BABY HUG; collaborate with the BABY HUG investigators in all phases of the study including planning, participant recruitment and follow-up, development and maintenance of a data management system for BABY HUG, preparing required statistical analyses; generate Core Laboratory work lists, report forms, blood specimen transmittal lists, and progress reports; and, assist in the preparation of manuscripts for publication. Medical Coordinating Center staff will undertake the primary responsibility for the collection, processing, storage and analysis of the study data, as well as cooperating with the Operations Committee to ascertain that the provisions of the Protocol are carried out by each Clinical Center.

### **15.2.8 National Institute of Child Health and Human Development**

A Memo of Understanding between the NHLBI and NICHD will allow the NICHD to perform pharmacokinetic (PK) studies under the Best Pharmaceuticals for Children Act (BPCA) to support a submission to the FDA for labeling of hydroxyurea for infants and very young children with sickle cell disease. Premier Research Group will be the NICHD's coordinating center and will assist in the design of PK studies and perform data quality control.

## **15.3 STUDY ADMINISTRATION**

### **15.3.1 Study Chairman and Vice-Chairman**

The Study Chairman and Vice-Chairman have been elected by the Steering Committee. The Study Chairman is Chairman of the Operations Committee and Steering Committee. The Study Chairman is responsible for overall conduct of the study and adherence to the study time table (see Protocol Appendix D). The Vice-Chairman acts in place of the Study Chairman in case of the Study Chairman's unavailability. Consultants to the Medical Coordinating Center will be available 24 hours a day for emergency unblinding of assigned study medication.

### **15.3.2 Steering Committee**

The Study Chairman will preside over the Steering Committee which will consist of the Principal Investigators from each Clinical Center and the Medical Coordinating Center, the NHLBI and NICHD Project Officers and (ex officio) directors of the central laboratories. This committee will be responsible for overseeing the writing of main papers as directed by the DSMB and as approved by the NHLBI.

### **15.3.3 Data and Safety Monitoring Board**

The Data and Safety Monitoring Board (DSMB) has been appointed by the NHLBI. DSMB voting members will include experts in sickle cell anemia, the clinical use of hydroxyurea, biostatistics and bioethics, who are not connected with the study, and ex officio (non-voting) members -- the Study Chairman and the Medical Coordinating Center Principal Investigator -- and representatives of the NHLBI and NICHD who will attend meetings to present information and

receive recommendations. The DSMB reviewed the initial study Protocol and will approve all changes made to it during the course of the study, review Data and Safety Monitoring Reports, and make recommendations on major Protocol changes and/or early release of study results. The Operations Committee will report any unexpected or unusual findings to the DSMB which may be convened ad hoc for a special review of BABY HUG any time circumstances so warrant. The DSMB will meet at least yearly, to review the annual BABY HUG report. It will review safety as the trial progresses, will evaluate treatment efficacy at pre-specified interim time points for possible early termination of the study, and will review any proposals to discontinue treatment of patients in a Clinical Center because of non-adherence to the Protocol.

DSMB meetings begin with an Executive Session at which summary notes are taken by a representative of the NHLBI. Other BABY HUG Steering Committee members do not participate in the Executive Session. The Study Chairman, Vice-Chairman, Medical Coordinating Center Principal Investigator and invited BABY HUG investigators join the DSMB for other parts of the agenda until the presentation of study outcome data. The BABY HUG Clinical Center investigators are excused for the study outcome presentation and discussion. Medical Coordinating Center staff take summary notes of the DSMB meeting from the end of the Executive Session through the presentation of study outcomes and discussion. At the end of the presentation of study outcomes and discussion, the Medical Coordinating Center staff are excused for the DSMB to meet in a second Executive Session. The NHLBI representative is responsible for recording summary notes of the second Executive Session and the recommendations of the DSMB. At the end of the second Executive Session, the BABY HUG investigators rejoin the DSMB for a preliminary review of DSMB recommendations. The NHLBI Executive Secretary of DSMB provides the summary notes and recommendations of the DSMB, in an expeditious and timely manner, to the Medical Coordinating Center. The Medical Coordinating Center communicates these recommendations to the BABY HUG Steering Committee. At the next DSMB meeting, the DSMB votes to accept (or revise) the summary notes recording transactions of the meeting and recommendations.



#### **15.3.4 Endpoints Evaluation**

Forms, images and records received from the Clinical Centers will be reviewed on a regular basis by committees consisting of experienced clinicians who are familiar with the area of special study evaluations (e.g., liver-spleen scans, neuropsychological tests and clinical events) and with the spectrum of illness in sickle cell anemia and who have no other connection with this study. They will receive materials for review from and return classifications of reports or other information to the Medical Coordinating Center for incorporation into the study database.

Exhibit 15-1

Pediatric Hydroxyurea Phase III Clinical Trial (BABY HUG)

ORGANIZATIONAL CHART

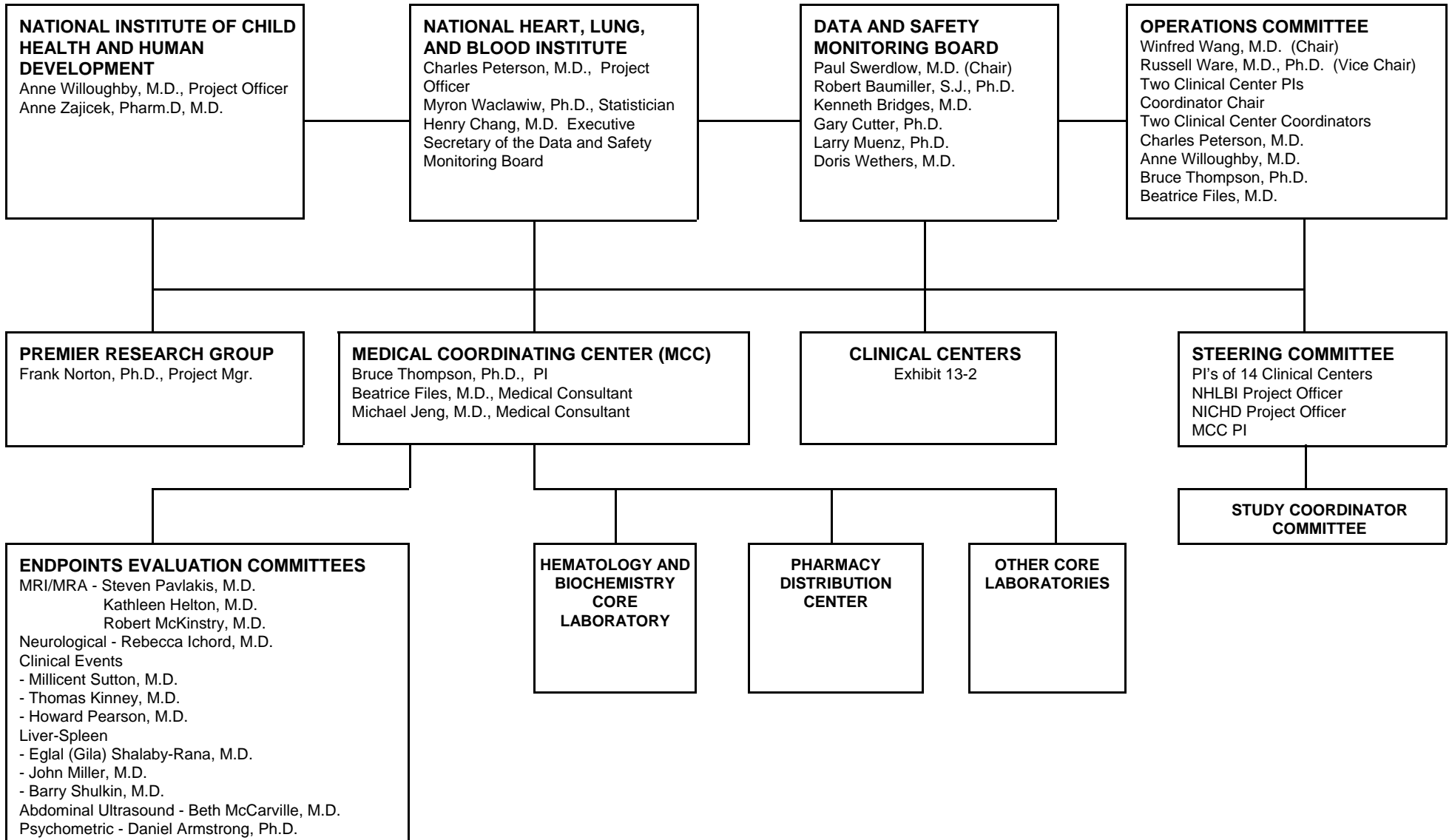

## Exhibit 15-2

### PARTICIPATING CLINICAL CENTERS

#### CLINICAL CENTERS

Children's Research Institute, Caterina Minniti, M.D. - 01  
(Washington, DC)

Duke University Medical Center, Sherri Zimmerman, M.D. - 02  
(Durham, NC)

Howard University College of Medicine, Sohail Rana, M.D. - 03  
(Washington, DC)

Johns Hopkins University School of Medicine, James F. Casella, M.D. - 04  
(Baltimore, MD)

Medical University of South Carolina, Julio Barredo, M.D. - 05  
(Charleston, SC)

St. Jude Children's Research Hospital, Winfred C. Wang, M.D. - 06  
(Memphis, TN)

State University of New York - Brooklyn (SUNY), Scott T. Miller, M.D. - 07  
(Brooklyn, NY)

University of Miami School of Medicine, Stuart Toledano, M.D. - 08  
(Miami, FL)

University of Mississippi Medical Center, Rathi V. Iyer, M.D. - 09  
(Jackson, Mississippi)

University of Texas Southwestern Medical Center, Zora R. Rogers, M.D. - 10  
(Dallas, TX)

University of Alabama, Birmingham, Thomas Howard, M.D. - 11  
(Birmingham, AL)

Drexel University, Carlton Dampier, M.D. - 12  
(Philadelphia, PA)

Emory University School of Medicine/CHOA, Peter Lane, M.D. - 13  
(Atlanta, GA)

Wayne State University, Ingrid Sarnaik, M.D. - 14  
(Detroit, MI)

#### MEDICAL COORDINATING CENTER

Clinical Trials & Surveys, Corp. (Baltimore, MD)  
Bruce W. Thompson, Ph.D., Principal Investigator  
Renee C. Rees, Ph.D., Co-Principal Investigator

#### PROJECT OFFICE

Division of Blood Diseases and Resources  
National Heart, Lung, and Blood Institute (Bethesda, MD)  
Charles Peterson, M.D., Project Officer  
Myron Waclawiw, Ph.D., Statistician  
Henry Chang, M.D., Executive Secretary of the Data and Safety Monitoring Board

**PEDIATRIC HYDROXYUREA PHASE III CLINICAL TRIAL (BABY HUG)  
MANUAL OF OPERATIONS**

**CHAPTER 16**

**POLICY MATTERS**

**16.1 INTRODUCTION**

Procedural guidelines are established to ensure that all investigators adhere to the protocol, to facilitate optimum use of data generated by the study, and to ensure optimal use of the resources of the Central Units and Medical Coordinating Center (for quality control in the study see Section 10.4).

**16.2 PROTOCOL VIOLATIONS**

The Medical Coordinating Center will create a list of protocol violations. Protocol violations are those which endanger patients, such as repetitive failure to obtain scheduled blood counts or failure to discontinue therapy promptly when so advised. Protocol deviations are those which impede the progress of the study, such as not filing reports in timely fashion (form delinquencies) and excessive delays in supplying materials (e.g, scans, other images or event reports) for central review.

After the protocol violation, a clinic will be asked to submit a proposal outlining how recurrence will be prevented. After a second protocol violation, clinics will not be allowed to recruit more patients, but will be able to follow those already recruited. After three protocol violations the Clinical Center may no longer be supplied with study drug. Prior to suspension of study treatments at a Clinical Center, the Study Chairman or Vice-Chairman, Medical Coordinating Center Principal Investigator and NHLBI and NICHD Project Officers will visit the Clinical Center and provide a site visit report to the Data and Safety Monitoring Board (DSMB) for recommendation on final action. Clinical Centers with the greatest difficulty in meeting their proposed goals for recruitment will also be site visited, and recommendations for improvement made to them, with a report to the DSMB. (Clinical Centers which are not having problems with performance will also be visited at least once

during the study, to assure quality of data produced). The Data and Safety Monitoring Board (DSMB) will be made aware of all protocol violations, and will consider discontinuing study treatment at the Clinical Center after a third violation.

The Medical Coordinating Center will document protocol deviations in performance reports, as well as notifying the Clinical Centers of them. Repeated protocol deviations which are not corrected will result in reports to the Data and Safety Monitoring Board (DSMB), the NICHD and the National Heart, Lung, and Blood Institute (NHLBI).

### **16.3 CHANGES IN PRINCIPAL INVESTIGATORS**

Over the seven year course of the trial, it is expected that changes in Principal Investigators (PIs) will occur in some of the Clinical Centers. These changes may be necessitated by movement of the Principal Investigators to another institution, illness, retirement, or change in responsibility within the same institution. When a change in PI occurs, the viability of the Clinical Center as a BABY HUG participant could become problematic. In this situation, retention of the established/experienced nurse coordinator may help ensure that the Clinical Center can continue to function effectively. When such a change occurs, it is understood that the contractual arrangement between the NHLBI and the Clinical Center will be reviewed and possibly altered. However, because of the profound influence that such a change may have on the remaining Clinical Centers in the conduct of BABY HUG, the members of the Steering Committee and/or the Operations Committee should have the opportunity to discuss and provide input into the decisions that are made.

As noted in Section 16.2, problems in the performance of a Clinical Center will be discussed by the Operations Committee. The Clinical Centers and/or their representatives, the Medical Coordinating Center, and the NHLBI and NICHD Project Offices should all participate in any decisions which involve turnover of Principal Investigators and/or Clinical Centers.

## **16.4 TYPES OF BABY HUG RESEARCH**

BABY HUG research and the resulting presentation and publications may be grouped into the following study categories.

1. Endpoint studies;
2. Data bank studies;
3. Ancillary studies.

The Steering Committee will exercise responsibility for all endpoint, data bank, and ancillary studies, and for all publications and presentations evolving from BABY HUG research, through the Publications Committee. BABY HUG investigators have agreed that all BABY HUG research is collaborative in nature. No investigator will publish BABY HUG data from any one Clinical Center or group of Clinical Centers without the written approval of the Publication Committee, the NICHD and the NHLBI.

Investigators at all BABY HUG sites, including the Medical Coordinating Center and the NHLBI and NICHD Program Offices, have equal status with regard to developing protocols, participating in such studies as are approved and collaborating in the development and publication of research papers based on BABY HUG material.

The procedures in this section for endpoint, data bank, and ancillary studies, and for publication of BABY HUG research results are similar to those used in other cooperative clinical trials. These procedures are intended to protect the interests of all investigators and patients in the trial, namely, to assure that study data conform to the requirements of study design, are accurately presented, authorship is appropriately acknowledged, and the text of all publications is well written with proper attention to the protection of patient privacy. All BABY HUG presentations are subject to review and approval by the NHLBI and NICHD.

### **16.4.1 Endpoint Studies**

An endpoint study is a study pertaining to the fundamental goals of the project (e.g., the evaluation of the efficacy of hydroxyurea in the prevention of chronic end organ damage) or which

involves data, such as treatment assignment, differences in hospitalization by treatment assignment, or mortality rates, which cannot be released prior to the end of the study. These studies will summarize the findings of BABY HUG, based on the entire study population, and will be written at the conclusion of follow-up or data collection.

#### **16.4.2 Data Bank Studies**

A data bank study is a study which uses data routinely collected on patients when they are screened for or enrolled in BABY HUG and analyzes these data to answer some scientific question. Data used in this research are not directly related to the fundamental goals of the study.

#### **16.4.3 Ancillary Studies**

An ancillary study is a study which uses supplementary data collected on patients who are screened for or enrolled in BABY HUG, over and above the data collection required by the BABY HUG Protocol. Such studies are usually restricted to consideration of a specific test technique or involve only supplemental data collected on some or all BABY HUG patients.

Approval and participation in ancillary studies are considered by the Steering Committee, the NICHD and National Heart, Lung, and Blood Institute (NHLBI) with the advice of independent review committees (the Data and Safety Monitoring Board or the Protocol Review Committee). Proposals for ancillary studies are submitted to the Medical Coordinating Center which distributes them to the Steering Committee for scientific review and Clinical Center Principal Investigator consideration with regard to feasibility and interest in participation in the ancillary study in each Clinical Center. Steering Committee members reply to a ballot distributed by the Medical Coordinating Center indicating their approval or disapproval of the ancillary study, the priority they would accord the ancillary study and whether or not their Clinical Center would participate in the ancillary study. Approval requires a majority vote.

### **16.5 CLINICAL CENTER ACCESS TO BABY HUG DATA FILES AT THE END OF THE STUDY**

At the end of the study, Medical Coordinating Center staff will produce a well documented data tape containing a refined (and reduced) set of the BABY HUG data for the purpose of analysis

by the BABY HUG investigators and eventual release to the public domain in accordance with NHLBI policy. Clinical Center directors may analyze the data on this data tape in their own centers, but prior to submission of articles for publication must submit the analyses proposed for publication to the Medical Coordinating Center, where they will be reviewed and computations replicated. Clinical Center directors who perform their own analyses are responsible for obtaining all support necessary for the data bank or ancillary study outside of regular study resources. The Medical Coordinating Center will be the center of study analysis activities as long as the BABY HUG investigators continue in their collaborative efforts.

## **16.6 PUBLICATION**

### **16.6.1 Papers Regarding Overall Study Issues**

1. “Overall study issues” are defined as those related directly to assessment/analysis of the study’s primary endpoint. The Operations Committee will make writing assignments for initial drafts of such papers; members of the Steering Committee will be invited to assist.
2. The authorship of these papers will include the investigators, the Medical Coordinating Center Director, and others as deemed appropriate by the Operations Committee; order will be determined by the Publication Committee. Other key personnel with institutional affiliations will be listed as a footnote. These will include the Center Coordinators and others who have a role in the study. Any changes in authorship must be approved by the Operations Committee. NHLBI and NICHD staff will not be co-authors of the primary results manuscript. NHLBI and NICHD staff will participate as co-authors of the design and secondary analyses papers as appropriate to intellectual interest.
3. These manuscripts are to be sent to all members of the BABY HUG Steering Committee for comment prior to its submission. Members must respond with comments or an indication that the manuscript is acceptable, and state their



willingness to accept authorship, within 10 days of distribution of a manuscript draft.

The process for final approval of the manuscript is outlined in items B1 m and n below.

## **16.6.2 Other Publications**

### **16.6.2.1 Papers**

1. Publications that fall under this policy are those that involve BABY HUG patients and/or include any data, from one or more Centers that participate in BABY HUG or any of its ancillary studies. Local Center studies that involve BABY HUG patients but no study data collected expressly for BABY HUG do not fall under this policy.
2. All study investigators and key personnel, described above, will be encouraged to submit proposals for papers to the Publication Committee. Proposals will be submitted in a defined format, which will state the research question or hypothesis and include a brief background statement supporting its importance (see Exhibit 16-1 Publications Worksheet). All topics must be reviewed by the Medical Coordinating Center (to determine if the study data will support the question) and be approved by the Operations Committee. If more than one investigator submits the same or overlapping proposals, primacy will be determined by the one dated earliest. A listing of projects will be prepared and maintained by the Publication Committee.
3. When approved, one individual will be assigned to serve as Chair of a Writing Committee. Usually, the person proposing the topic will assume this role. However, before an investigator is awarded the chairmanship of a second topic, investigators will be polled to allow other interested investigators an opportunity to serve as lead author/Writing Committee chair.

4. Each Writing Committee will include a representative from the Medical Coordinating Center and approximately 5-6 other authors. Approved writing projects will be announced so that investigators may request membership on the committee. If more investigators wish to participate than can be accommodated, investigators enrolled on fewer writing committees will be given priority. Investigators wishing to serve on multiple committees may be asked to prioritize their choices; an attempt will be made to assign topics to those who indicate a high level of interest.
5. For ancillary projects approved by the Steering Committee, the ancillary project P.I. will be the Writing Committee Chair for any manuscripts that arise from his/her research. The Writing Committee membership will be selected by that individual and will consist of some or all of the BABY HUG PIs who are participating on the project. BABY HUG will be acknowledged in any publication that uses data obtained as part of the ancillary project. Review of manuscripts by the Publication Committee and NHLBI-NICHD will follow the same process as described above.
6. The Publication Committee will determine the priority with which topics will be analyzed by the Coordinating Center.
7. Once analysis has begun, the manuscript must progress in a timely manner. In general, a draft manuscript should be completed within six months of availability of the required data analyses; Committee Chairs are encouraged to format their papers and write Introduction, Methods and a preliminary Discussion even prior to Results being available. If progress is unsatisfactory, the Publication Committee will propose a replacement for the Writing Committee Chair. A replacement must be approved by the Operations Committee.

8. All authors are expected to be full participants in manuscript preparation. If the Writing Committee Chair determines that a member is not participating, s/he may request that person's removal by notifying the Publication Committee.
9. The Publications Committee will maintain a list of Writing Committee Chairs and membership. This will be presented at each meeting of the Steering Committee along with the priority and status of any manuscripts. It is the responsibility of the Publications Committee to recognize potentially overlapping writing projects and consolidate proposals where necessary. If needed, disputes regarding any redistribution of projects or responsibilities can be referred to the Operations Committee for resolution
10. All publications will include the names of all members of the Writing Committee as masthead authors followed by the phrase, "for the Investigators of the Pediatric Clinical Trial of Hydroxyurea in Sickle Cell Anemia (BABY HUG)." The Writing Committee Chair will determine the order of authorship based on effort and contribution. Usually the name of the Writing Committee Chair will be listed first. The Chair may choose to add the names of other individuals to the author list depending on participation in the design/performance of the project and/or preparation of the manuscript. All publications will acknowledge the support of NHLBI and NICHD.
11. The name, title and affiliation of all key personnel (see section A.2) will be listed in a footnote to all manuscripts submitted. This listing will be established and maintained by the MCC.
12. The lead author will usually be designated as corresponding author. Requests for reprints will be directed to that person. The MCC will ensure that all participating centers receive copies of all study publications.

13. All manuscripts will be submitted to the Publication Committee prior to submission for publication. The Publication Committee will choose two to three Investigators as reviewers. The P.I. of the MCC will review the statistical analysis of each manuscript for accuracy even if local statistical resources are used for that data analysis. The review process will be accomplished in a period of no more than two weeks.
14. After suggested changes have been considered, the manuscript will be submitted to the Publication Committee Chair and NHLBI Project Officer prior to submission to a journal. In order to balance the oversight responsibility of the National Heart, Lung, and Blood Institute (NHLBI) with the authorization provided the contractor by the Rights in Data clause of this contract, the NHLBI has established a process to review manuscripts produced under this contract. Please note that the NHLBI does not require contractors to seek the Institute's approval of manuscripts.

In order to have sufficient time to conduct a meaningful review, the Institute's Project Officer and Contracting Officer must have advance notice of intent to submit a manuscript for publication at least 45 days prior to submission to the publisher. The advance notice should briefly describe the plans for publication of the manuscript.

Concurrently or as soon as possible following this notice, the manuscript should be provided to the Project Officer for DSMB review and final approval by NHLBI/NICHD. Any comments from the NHLBI/NICHD will be provided in writing within 15 days after receipt of the manuscript by the Project Officer. Comments expressed by the NHLBI about the manuscript shall not be a cause for action under the Disputes clause of the contract by either NHLBI or the contractor,

since the NHLBI does not approve manuscripts and draft manuscripts are not contract deliverables.

#### **16.6.2.2 Abstracts**

1. Abstracts that fall under this policy are those that involve BABY HUG patients and/or include any data, whether from one or many Centers, that were acquired as part of BABY HUG or any of its ancillary studies. Local Center studies that involve BABY HUG patients but no study data do not fall under this policy.
2. Abstracts may be prepared for submission to any appropriate meeting. Usually the topic will be based on or related to one already assigned to an established Writing Committee. Alternatively, topics that differ from those established for Writing Committees may be proposed utilizing the Publications Worksheet.
3. Abstract topics must be approved by the Publications Committee before data will be made available and analysis begun by the Medical Coordinating Center. In addition, the Publications Committee Chair, the PI of the Study and the MCC will confer and attempt to balance the desire to get abstracts presented with the need for ongoing statistical analyses for the main study or manuscript preparation. Accordingly, approval in concept may not mean that the MCC can respond to all abstract requests in the time frame desired by the proposer. Thus, investigators are strongly encouraged to plan abstract proposals well in advance of deadlines so that sufficient time to prepare abstracts.
4. The decision to submit abstracts that arise from Ancillary Projects will be the responsibility of the individual managing the project. Some projects may not require MCC assistance and therefore do not need to go through the above prioritization and approval process. The Writing Committee should be chosen from those Principal Investigators who are project participants.

5. Authorship of abstracts will be determined as for manuscripts (described above), depending on whether the abstract pertains to overall study issues or a subissue arising from a writing project or ancillary project.
6. An abstract must be submitted to the Publication Committee Chair at least 14 days prior to the deadline for submission. Abstracts must thus be sent for comment and approval by potential authors 18-21 days prior to submission deadline; potential authors who do not respond promptly may be removed. Upon receipt, the Publication Committee Chair will circulate the abstract to the Steering Committee for immediate review, and any comments will be returned to the Writing Committee Chair and Publication Committee Chair within four days. A **final** version will be forwarded for final approval by the Publication Committee Chair and the Project Officer at least seven days prior to submission deadline for DSMB review and approval.

## **16.7 CONFLICT-OF-INTEREST**

BABY HUG investigators and their immediate family will not buy, sell, or hold stock options in any of the companies\* providing medication (or making competing products) under study from the time the recruitment of patients for the trial begins until funding for the study in the investigator's unit ends and the results are made public; or from the time the recruitment of patients for the trial begins until the investigator's active and personal involvement in the study or the involvement of the institution conducting the study (or both) ends.

Each investigator will agree not to serve as a paid consultant to the companies during these same periods. The guidelines will also apply to the investigator's spouse and dependents. The Medical Coordinating Center will hold and update annually conflict-of-interest statements from each investigator.

\*Bristol-Myers Squibb, Par Pharmaceuticals

Certain other activities are not viewed as constituting prohibited conflicts-of-interest but must be reported annually to the Medical Coordinating Center: the participation of investigators in education activities supported by the companies (permitted only if no honorarium is paid to the investigator); the participation of investigators in other research projects supported by the companies; and, occasional scientific consulting to the companies on issues not related to the products in the trial and for which there is no financial payment or other compensation. The BABY HUG conflict-of-interest policy will incorporate the NHLBI and U.S. Food and Drug Administration (FDA) policies on conflict-of-interest for investigators.

The BABY HUG investigators will not accept any restraint on freedom of publication.

EXHIBIT 16-1

**BABY HUG Publications Worksheet**

Submit this worksheet to the Publications Committee Chair. If you would like to provide more detail about your proposal, you may attach one or two additional pages. Please note that the Committee must approve the final draft of your paper before it is submitted.

Date submitted to the Publications Committee \_\_\_\_\_

P r o p o s e d t i t l e o f p a p e r  
\_\_\_\_\_

Possible journal for submission? \_\_\_\_\_

Members of Writing Committee

Proposed Chair \_\_\_\_\_

Possible Members \_\_\_\_\_

\_\_\_\_\_  
\_\_\_\_\_

Introduction. (A brief statement of the scientific context and interest in this question.)

Main questions or issues to be addressed by this paper.

Methods pertinent to this paper (eg, inclusion/exclusion, data required, statistical analysis).

Anticipated Results.

Figures/Tables Required

Discussion. Provide a few points that you plan to discuss regarding the limitations, implications, and significance of the findings.

Conclusions.

Key References.



# PEDIATRIC HYDROXYUREA PHASE III CLINICAL TRIAL (BABY HUG) MANUAL OF OPERATIONS

## CHAPTER 17

### USE OF THE BABY HUG WEB SITE

#### 17.1 OVERVIEW

The BABY HUG Web Site is available for use by all BABY HUG Clinical Center and Project Office staff. For questions about the web site, see the BABY HUG Address Directory page for the Programmer/Analyst at the MCC.

To access the BABY HUG web site, type <https://www.ctascstudies.com> into your browser's address window. Authorized users will be confidentially given a user log-on account and password. Your connection to the BABY HUG web site will be terminated after 20 minutes of inactivity. If that occurs, you will need to log back on the web site to continue.

Most documents available on the BABY HUG web site are in Portable Document Format (PDF). Documents in PDF preserve the exact look and content of the originals. Adobe Acrobat Reader 4.0 or higher is required to read and print the PDF documents. This program is free and is available from Adobe at <http://www.adobe.com/products/acrobat/readstep.html>. Each of the BABY HUG web site pages has a link to Adobe. When installing the program from the Adobe web site, follow the directions given on that web site. To open a PDF document with the Adobe Acrobat Reader on the BABY HUG web site, click on the file name.

#### 17.2 CONTENTS OF THE BABY HUG WEB SITE

The BABY HUG home page (see Exhibit 17-1) identifies and provides links to the categories of information available on the web. To review the contents of each category, click on the category heading. The page for that category is then displayed. Each page lists the documents available in that category. The list can be quite long. To aid in finding documents in a category, a drop-down list is provided to limit the list of documents to a smaller subset of that category. Below is a description of the documents contained in each category.

## Protocol/Manual

The Protocol, Manual of Operations (MOO) and related documents in PDF format, are accessible from the Protocol/Manual page.

## Memos

Important BABY HUG study issues are distributed by numbered memos which are available in PDF format on the Memos page.

## Minutes

Operations Committee, Steering Committee (Conference Calls and Meetings) and Coordinator Conference Call Summary Notes are available in PDF format on the Minutes page.

## Q & A

Frequently asked questions and answers about the BABY HUG Protocol or MOO are available for viewing on the Q & A page.

## Forms

Study forms (including specimen transmittal forms) in PDF format are available for viewing and printing.

## Form QxQs

Instructions (Form QxQs) for each BABY HUG form provide specific details about each item on the form. These instructions are available for viewing on the Form QxQs page. In addition, general instructions for completing forms are located on this web page.

## Study Tools

The Enrollment and Eligibility Screening Birth Dates calendar, the study address directory, SAE Reporting Procedure and other study management tools are available in PDF format on the BABY HUG Study Tools page.

## News & Events

Announcements of upcoming events are available in PDF format on the BABY HUG News & Events page.

## Presentations

The Powerpoint data management training session slides are accessible from the BABY HUG Presentations page. Click on the Powerpoint presentation name to open the presentation in Powerpoint. If Powerpoint 97 or Powerpoint 2000 is not available on your computer, download the Powerpoint 97 viewer from the Internet at <http://office.microsoft.com/downloads/2000/Ppview97.aspx>. The BABY HUG Presentations page has a link to this site.

## Publications

Published publications (including abstracts) in PDF format as well as manuscripts in progress are available on the BABY HUG Publications page. Also available are the publication guidelines.

## Reports

Study reports (e.g. Clinical Center Quarterly Performance Reports and Steering Committee Baseline Data Reports) are available on the BABY HUG Reports page.

## Form Entry

Users must apply for "Data Entry and Content" on the BABY HUG Site Application (see Section 17.4) to have access to Form Entry on the BABY HUG web site. This category will be listed on the BABY HUG home page only for users who have applied for and are authorized for this type of access.

### **17.3 SYSTEM REQUIREMENTS TO ACCESS THE BABY HUG WEB SITE**

In order to use the web site, the user at the Clinical Center must have a computer that has the following configuration.

1. Connection to the Internet at 56 KB or higher.
2. Pentium Class PC running Windows 98, NT, ME, 2000 or XP.
3. Microsoft Internet Explorer 5 or greater, or Netscape 4.5 or greater. The browser must be set to accept cookies. Internet Explorer 4 may work, but a browser upgrade is recommended if there are problems.

## **17.4 SITE AND USER APPLICATIONS**

The Principal Investigator of each Clinical Center should complete a BABY HUG Site Application (see Exhibit 17-2) and send this application to the BABY HUG MCC by facsimile transmission (443-524-2320). The e-mail address on this site application will be used to e-mail materials such as study memos, updates and edit messages to the Clinical Center on a regular basis.

Each staff member at the Clinical Center designated to use the web site must complete a BABY HUG User Application (see Exhibit 17-3) and send it to the BABY HUG MCC by facsimile transmission (443-524-2320). A user may request authorization for “Content Only”; this allows the user to browse the web site content and print documents. A “Content Only” user does not have the authorization to enter, modify or view data. Users requesting “Content Only” receive a user log-on and password.

Clinical Center staff may request authorization for “Data Entry and Content”; this allows the user to browse and print the web site content as well as to enter, modify and view data for patients enrolled in his/her Clinical Center. Before requesting “Data Entry and Content” use, the system requirements for Internet Data Entry should be reviewed (see Chapter 10).

## **17.5 PRINTING STUDY FORMS OR OTHER DOCUMENTS ON THE BABY HUG WEB SITE**

From the “Forms” section, click on the file name to open a PDF document. The Adobe Acrobat Reader automatically opens and the document is displayed on the screen. The document can then be read on the screen or printed using the Adobe Acrobat menu.

**Clinical Trials & Surveys - Microsoft Internet Explorer**

File Edit View Favorites Tools Help

Back Forward Stop Refresh Home Search Favorites Media History Mail Print Edit Discuss

Fri, 20 May 2005 14:56:03 UTC

# BABY HUG

## WEB STUDY Welcome!

**Clinical Trials & Surveys**

- Home**
- Protocol / Manual**
- Memos**
- Minutes**
- Q & A**
- Form Entry**
- Forms**
- Form QxQs**
- Study Tools**
- News & Events**
- Presentations**
- Publications**
- Reports**

<b>▶ Protocol/Manual</b>	<b>▶ Form Entry</b>	<b>▶ News &amp; Events</b>
Study Protocol and Manual, Ancillary Study Protocols and other related documents.	Enter, correct and review study form data. (For certified users only?)	Meetings, conference calls, events and newsletters.
<b>▶ Memos</b>	<b>▶ Forms</b>	<b>▶ Presentations</b>
Numbered memos.	Current study forms.	Power Point slide presentations.
<b>▶ Minutes</b>	<b>▶ Form QxQs</b>	<b>▶ Publications</b>
Minutes for meetings and conference calls (if applicable).	Form instructions - Addressed question by question.	Published publications as well as manuscripts in progress.
<b>▶ Q &amp; A</b>	<b>▶ Study Tools</b>	<b>▶ Reports</b>
Frequently asked questions and answers, and people to contact.	Schedules, time lines, applications, SAE reporting procedure, address directory and other study management tools.	Recruitment, performance and other study reports.

Internet

**WEB STUDY**

Please Log-In

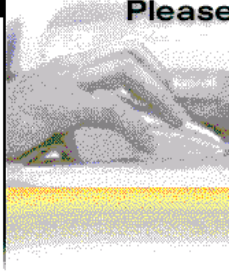

**BABY HUG SITE APPLICATION**

**Complete one form per site.  
Please type or print clearly.  
FAX to C-TASC (443) 524-2320**

Date:

Site Number

Site Name:

Principal Investigator:

Site Address:

Site e-mail (required):

Site Phone Number:

area code ( )

**For Computer Services Use Only!**

Date Completed:

Completed by:

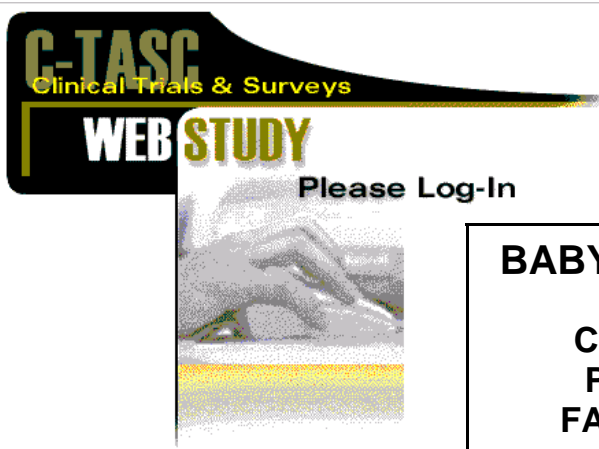

**BABY HUG USER APPLICATION**

**Complete one form per user.  
Please type or print clearly.  
FAX to C-TASC (443) 524-2320**

Date: \_\_\_\_\_

Site Number/Name: \_\_\_\_\_

User Name: \_\_\_\_\_

User e-mail: \_\_\_\_\_

User Phone Number: \_\_\_\_\_ area code (    ) \_\_\_\_\_

Computer / Operating System: \_\_\_\_\_

Browser / Version: \_\_\_\_\_

Certification Requested:  Content Only – The user may browse web site content such as manuals and forms, but may not enter, modify or view data.  
(Select One)  Data Entry and Content – The user may browse web site content such as manuals and forms, and may enter, modify and view data.

For Computer Services Use Only!		
Test IDs:	_____	Comments:
Passed Comparison:	_____	_____
Date Certified:	_____	_____
Completed by:	_____	_____
USER LOGON Assigned:	_____	_____
USER PASSWORD Assigned:	_____	_____
USER NUMBER Assigned:	_____	_____

**PEDIATRIC HYDROXYUREA PHASE III CLINICAL TRIAL (BABY HUG) PROTOCOL  
MANUAL OF OPERATIONS**

**APPENDIX A**

**PATIENT TIMELINE**

Pre-Enrollment

- Local CBC Blood Specimen
- Core Laboratory Blood Specimens
  - Hematology
  - Biochemistry
  - Cytogenetics
  - Pitted Cell Count
  - DNA
  - Immunology (MMR, T-cell, pneumococcal/serum opsonic)
- Anthropometrics (Height, Weight and Head Circumference)
- Liver Palpation
- Spleen Palpation
- Urinalysis
- Urine Concentrating Ability
- O<sub>2</sub>% Saturation
- Bayley Examination
- Vineland Questionnaire
- Neurological Examination and Questionnaire
- Liver/Spleen Scan
- Abdominal Sonogram
- TCD

Randomization/Enrollment

- ATRS

Treatment Initiation

- Core Laboratory Blood Specimens
  - Hematology
  - Biochemistry
- Local CBC Specimen
- Weight
- DTPA Assessment of GFR
- First Study Treatment Dose
- HU assay



### Routine Study Visits

- Spleen Palpation
- Local CBC Specimen
- Weight
- Retrieve Old Study Treatment
- Dispense New Study Treatment
- Immunology (weeks 6, 48, 52, 56, 60 only)
- HU assay (4 weeks only)

### Quarterly Visit (3, 9, 15 and 21 Month)

- O<sub>2</sub>% Saturation
- Anthropometrics (Height, Weight and Head Circumference)

### Semi-Annual Visit (6 and 18 Month)

- Anthropometrics (Height, Weight and Head Circumference)
- Pitted Cell Count
- Liver Palpation
- O<sub>2</sub>% Saturation
- Core Laboratory Blood Specimens
  - Hematology
  - Biochemistry

### Annual Visit (12 Month)

- Anthropometrics (Height, Weight and Head Circumference)
- Immunology
- Pitted Cell Count
- Liver Palpation
- O<sub>2</sub>% Saturation
- Bayley Examination
- Vineland Questionnaire
- Neurological Examination and Questionnaire
- TCD
- Core Laboratory Blood Specimens
  - Hematology
  - Biochemistry

### End of Study Treatment Visit (24 Month)

- Core Laboratory Blood Specimens
  - Hematology
  - Biochemistry
  - Cytogenetics
  - Pitted Cell Count
  - DNA
  - Immunology
- Local CBC Specimen

- Anthropometrics (Height, Weight and Head Circumference)
- Liver Palpation
- Spleen Palpation
- Urinalysis
- Urine Concentrating Ability
- O<sub>2</sub>% Saturation
- Bayley Examination
- Vineland Questionnaire
- Neurological Examination and Questionnaire
- Liver/Spleen Scan
- Abdominal Sonogram
- TCD
- DTPA Assessment of GFR
- HU Assay
- Retrieve Old Study Treatment

**PEDIATRIC HYDROXYUREA PHASE III CLINICAL TRIAL (BABY HUG) PROTOCOL  
MANUAL OF OPERATIONS**

**APPENDIX B**

**STUDY FORMS AND DATA COLLECTION INSTRUMENTS**

**Form No.      Form Name**

Clinical Center and Staff Applications/Disclosures

Appl ATRS	ATRS Application Form
Appl Site	Website Site Application Form
Appl User	Website User Application Form
Finan Disc	Financial Disclosure Form

To be maintained in Clinical Centers

A	Patient information record (Form 01)
B	Signed, witnessed informed consent
C	Notification of Transfer Patient

Eligibility, Randomization and Treatment Initiation

04	Eligibility Screening I
05	Eligibility Screening II
06	History and Physical Examination at Entry
07	Demographic and Household Information
08	Growth History
20	ATRS Automated Randomization Worksheet
21	Treatment Initiation Visit
22	DTPA/GFR and HU Assay
23	HU Assay at 1 Month Post-Treatment Initiation

Individual Procedure Results/Report Forms (Repeated at various visits)

- 31 Study Visit
- 32 Missed Visit
- 33 Quarterly Visit (3, 9, 15 and 21 Month)
- 34 Six-Month or 18-Month Visit
- 35 Twelve-Month Visit (52 Weeks)
- 36 End of Randomized Study Treatment
- 37 Local CBC Results
- 38 Hold Restart
- 40 Bayley's
- 41 Vineland Summary
- 42 Vaccination Record and Immunology Specimen Collection
- 43 Neurological Examination and Questionnaire
- 44 Liver-Spleen Scan Performance
- 45 Abdominal Sonogram (Ultrasound) Performance
- 46 Transcranial Doppler (TCD) Performance

Events and Adverse Events

- 50 Reportable Event and/or Hospitalization

Study Treatment Management Forms

- 64 Study Treatment Stop Order
- 65 Restart Treatment Order
- 66 Study Treatment Dosing Irregularity

Additional Information Form

- 80 Additional Information

### Central Readings of Study Findings

- 84 Liver-Spleen Scan Central Reading
- 85 Abdominal Sonogram (Ultrasound) Central Reading
- 87 Clinical Events Classification

### Transmittal Lists

- 101 Hematology Specimen Transmittal List
- 102 Biochemistry Specimen Transmittal List
- 103 Pitted Cell Counts Specimen Transmittal List
  
- 105 Cytogenetics Specimen Transmittal List
- 106 DNA Specimen Transmittal List
- 107 MMR Antibody Specimen Transmittal List
- 108 Pneumo Antibody/ Serum Opsonic Specimen Transmittal List
- 109 CD4/CD8 T-cells Specimen Transmittal List
- 110 HU Assay Specimen Transmittal List
- 111 Liver/Spleen Scan Transmittal List
- 112 Abdominal Sonogram Transmittal List

### Certification Forms

- 120 BABY HUG Certification Numbers
- 121 Request for Clinical Center Certification for Participation in BABY HUG
- 122 Notification of Clinical Center Certification
- 123 Request for Co-Investigator Certification
- 124 Request for Clinic Coordinator Certification
- 125 Request for Neuropsychologist Certification
- 126 Request for Neurologist Certification
- 127 Request for Primary Endpoint Person Certification

# PEDIATRIC HYDROXYUREA PHASE III CLINICAL TRIAL (BABY HUG) PROTOCOL MANUAL OF OPERATIONS

## APPENDIX C

### RADIATION GUIDELINES

*The following guidelines are obtained from NCRP Report No. 116 "Limitation of Exposure to Ionizing Radiation", National Council on Radiation Protection and Measurements, 1993.*

The report recommends that for the general public, the annual effective dose not exceed 1mSv for continuous or frequent exposure, with a maximum annual effective dose limit of 5 mSv to allow for infrequent annual exposures. This recommendation applies to exposures from man-made or sources other than medical and natural background. Medical exposures are excluded in this recommendation because it is assumed that the radiation exposure will have personnel benefit to the individual (pgs. 45-47). This recommendation includes children less than 18 years of age for education and training purposes (pg. 53). In the application of this recommendation, all exposures should be kept As Low As Reasonably Achievable (ALARA) and any activity should be justified on the basis that the expected benefits exceed the overall detriment it causes (pg. 10).

*The following dose guidelines are obtained from Essentials of Nuclear Medicine Imaging, FA Mettler, Jr. and MJ Guiberteau, Grune & Stratton, Inc. (1983).*

The amount of radiation received by the radionuclide assessment of the liver (Liver-Spleen scan) or evaluation of renal function (DTPA-GFR) is well within the guidelines for patient exposure for this population group. The BABY HUG patients will receive 0.05 mCi/kg of <sup>99m</sup>Tc Sulfur Colloid for the liver-spleen scan; this amounts to approximately 1 mCi for the largest patients at the end of the full study. The usual dose for this procedure is 4-6 mCi, with an estimated 0.2 - 0.4 rad/mCi absorbed by the liver and 0.1 - 0.4 rad/mCi absorbed by the spleen. The BABY HUG patients will receive 500 µCi of <sup>99m</sup>Tc DTPA for the GFR study. The usual dose for this procedure is 10-20 mCi, with an estimated 0.03 - 0.3 rad/mCi absorbed by the kidneys. The amount of radiation received from these procedures is less than that received from other radiologic procedures (CT scan) that

have not been adjudged to be a risk to the patient.

# PEDIATRIC HYDROXYUREA PHASE III CLINICAL TRIAL (BABY HUG) PROTOCOL MANUAL OF OPERATIONS

## APPENDIX D

### GUIDELINES FOR STANDARD CLINICAL CARE INCLUDING ACUTE EVENTS

#### INTRODUCTION

The basic principles of supportive care for the infants with sickle cell anemia enrolled in the BABY HUG trial are based upon the recommendations found in several publications (Mountain States Regional Genetic Services Network, 2000; Council of Regional Networks for Genetic Services (CORN), 2000; Ohene-Frempong, 2001; US Department of Health and Human Services, Public Health Service, 1993). Supportive care should be similar whether the patient is receiving hydroxyurea or placebo. For the ease of clinicians involved with participants, all patients should be treated as if they were receiving hydroxyurea. The cooperation of all medical staff involved in the clinical care of study patients will be solicited to enhance patient adherence to the BABY HUG Protocol and avoid compromise of blinding of treatment assignments.

Common clinical events are addressed in specific sections below. At no time should the performance of the study Protocol be allowed to compromise the elements of good clinical care of BABY HUG participants.

#### IMMUNIZATIONS

All routine pediatric immunizations should be given as per standard clinical recommendations, including vaccination against diphtheria, pertussis, tetanus, polio, measles, mumps, hepatitis B, rubella and *Haemophilus influenzae* type b. Immunizations against hepatitis A and varicella may be given if indicated and commonly available locally. These vaccines should be provided through usual local pediatric primary care mechanisms if possible. Any and all vaccines may be withheld for medical indications (e.g., allergy or history of prior reaction) or parental preference.



All participants should receive all recommended doses of pneumococcal vaccine according to the following schedule. A history of vaccination with pneumococcal conjugate vaccine (Pnevnar or PCV7), including date(s) given, must be documented by the BABY HUG Clinical Center and reported to the Medical Coordinating Center for each infant enrolled. Patients deficient in PCV7 immunizations at study entry should be brought up to date by the Clinical Center as soon as possible. Bacteremia and meningitis with *S. pneumoniae* will be monitored closely as clinical events in BABY HUG. Further, the antibody response to pneumococcal vaccination will be measured in the study. The total number of doses required is dependent upon the age of the patient when the first dose is given even if the interval between doses is longer than intended. Adequate series of vaccinations are indicated in the table below.

Pneumococcal Conjugate Vaccine Series (Pnevnar or PCV7)

<u>Age at first dose (mos)</u>	<u>Primary Series</u>	<u>Additional Dose**</u>
2-6	3 doses, 2 months apart*	1 dose at 12-15 months
7-11	2 doses, 2 months apart*	1 dose at 12-15 months
12-23	2 doses, 2 months apart	
more than 24 months	1 dose	

Pneumococcal polysaccharide vaccine (pneumovax or PV23)

<u>Age at first dose (mos)</u>	<u>Primary Series</u>	<u>Additional Dose**</u>
less than or equal to 24 months	1 dose	1 dose at 60 months

\* For children vaccinated before 1 year the minimum interval between doses is 4 weeks.

\*\*Additional dose should be 8 or more weeks after the primary series has been completed.

Measles, Mumps, and Rubella vaccine (MMR): one dose of the vaccine should be documented as given between 12 and 15 months of age and then repeated between 4 and 6 years of age. The immunologic response to this vaccine will be assessed to document the ability of patients receiving either hydroxyurea or placebo to respond to these antigens. Thus, the date of this immunization must be recorded for each patient by the Clinical Center and reported to the Medical Coordinating Center. Parents will be encouraged, and assisted by the BABY HUG Clinical Center as necessary, to obtain this vaccine as early in the scheduled vaccine interval as possible.

Influenza vaccine: the annual flu vaccine is encouraged for all infants 6 months of age or older. The first year this is administered this should be given as two 0.25 ml doses, with a minimum of four weeks between doses. Each subsequent flu season, one dose is given. A single dose of 0.25 ml is given to patients from 6 to 35 months of age and 0.5 ml to patients over 36 months of age.

## **PROPHYLACTIC MEDICATIONS**

Twice daily prophylactic penicillin will be prescribed from first medical contact. This should have already been initiated prior to enrollment in BABY HUG. The doses are from birth to 35 months of age - 125mg po BID – and over 36 months of age - 250 mg po BID. Either the liquid formulation, which must be kept refrigerated and refilled every 2 weeks, or tablets may be used (Mountain States Regional Genetic Services Network, 2000; American Academy of Pediatrics, 2000). Erythromycin estolate 250 mg po BID may be used for penicillin allergic patients (Mountain States Regional Genetic Services Network, 2000; Council of Regional Networks for Genetic Services (CORN), 2000; Ohene-Frempong, 2001; US Department of Health and Human Services, Public Health Service, 1993). Reminders about the need for this prophylactic agent should be offered at each clinical contact.

Folic Acid supplementation will not be required for patients on BABY HUG. It may be prescribed at parental or Clinical Center preference. It is very unlikely that infants enrolled on this

study will be deficient in folate. The majority will either still be drinking or just have been weaned from high folic acid containing infant formula. The widespread fortification of a variety of foods with folic acid and the generally adequate diets of young patients with sickle cell anemia should prevent folate deficiency.

Supplemental iron will be prescribed only for documented iron deficiency or bleeding or similar reasons. Adequacy of iron stores will be documented at study entry and every six months and supplemented as necessary.

## **PARENT EDUCATION**

All parental and caregiver education routinely offered to families of patients with sickle cell anemia should be provided to BABY HUG participants. However, in order to standardize some aspects of care the following suggestions are offered for each Clinical Center to review with BABY HUG families at quarterly visits :

Fever: The temperature should be measured if the child feels hot. Families should be advised to have a thermometer at home and taught how to accurately use it. They should be instructed to seek medical attention for any temperature over 101.5<sup>0</sup>F regardless of route (oral, axillary or rectal) measured. The parent or caregiver should be cautioned against use of antipyretics unless recommended by treating physicians. They are encouraged to seek medical attention for all febrile episodes. The medical response to a reported history of fever should include a complete blood count, blood culture, and an empiric dose of parenteral antibiotics (usually ceftriaxone) effective against encapsulated organisms. Admission or outpatient management will be at local option (Mountain States Regional Genetic Services Network, 2000; Council of Regional Networks for Genetic Services (CORN), 2000).

Neutropenia: A complete blood count with differential white blood cell count should be performed at the Clinical Center or site of care with each febrile event. If the absolute neutrophil count (ANC) on the local blood count is below 1,000/uL, the child should be admitted to the hospital

for observation and parenteral antibiotics. BABY HUG study medication should be stopped and the Medical Coordinating Center notified. If the ANC on the local blood count exceeds 1,250/uL prior to hospital discharge, BABY HUG study medication should be resumed at the same dose as on admission. If on hospital discharge the ANC on the local blood count is still below 1,250/uL, the patient and family should be instructed not to resume treatment until a local scheduled blood specimen shows a count of 1,250/ $\mu$ L or greater.

If the absolute neutrophil count on local blood count is between 1,000/uL and 1,250/uL during evaluation for a febrile event, the BABY HUG study medication should be stopped. The patient may be treated as an outpatient or admitted at local option. If admitted, BABY HUG study treatments will be stopped as above. If managed as an outpatient, the patient should remain off BABY HUG study medication until a scheduled blood count is performed and the count is 1,250/ $\mu$ L or greater.

Hospitalization: The BABY HUG study medication should be continued during all clinically indicated hospitalizations unless the ANC of a BABY HUG participant is found to be below 1,250/uL. Then the study medication should be stopped and the Medical Coordinating Center notified. Study treatment should be resumed at the same dose when the ANC on the local blood count exceeds 1,250/uL. If the patient is otherwise able to be discharged to outpatient management before the ANC recovers, the patient and family should be instructed not to resume treatment until the next scheduled local blood specimen can be reviewed. The Clinical Center Principal Investigator and Nurse Coordinator will not review the local blood counts for mean corpuscular volume (MCV) or other parameters that may compromise blinding of the patient's study medication assignment.

Positive Cultures: The blood culture (plus cerebrospinal fluid -- CSF -- or urine cultures if performed) obtained at all febrile encounters will be monitored by each Clinical Center. Positive cultures from normally sterile sites will be managed according to Clinical Center preference and

reported to the Medical Coordinating Center. The organism should be identified; if possible, and antibiotic sensitivities obtained. The serotype of *Streptococcus pneumoniae* isolates from sterile sites for patients on this trial should be obtained if possible.

Varicella: The family should be instructed to contact the Clinical Center for suspected varicella infection. If the child is febrile, management should be as above. If fever does not exceed 101.5° F, no extra CBC is required. BABY HUG study medication should be stopped for all episodes of varicella and the Medical Coordinating Center notified. BABY HUG medication should be resumed at the same dose when all lesions are crusted over. Acyclovir may be prescribed at Clinical Center discretion.

Tuberculosis: Surveillance for exposure to tuberculosis is standard in many pediatric clinic populations. If a patient receiving BABY HUG study medication is incidentally found to have a positive tuberculosis skin test (PPD), a repeat PPD and chest radiograph should be done per standard practice. If the chest radiograph and physical examination show no signs of active tuberculosis, the child should be treated as appropriate and the study medication continued once the PPD treatment is no longer a risk for continuation of study treatment. If the chest radiograph is positive or there is evidence of active infection with tuberculosis, the child's situation should be discussed with the Operations Committee.

Transfusion Therapy: The use of blood products as therapy for a clinical event will be at the option of the Clinical Center. The red cell products selected should be matched for Rh (CcDEe) and Kell if possible. Similarly leukofiltration of all cellular blood components should be considered, if available. Chronic transfusion therapy for any indication, an option that would remove the patient from study treatment, should be discussed with the Operations Committee prior to implementation.

Steady State Hematologic Values: Many clinical decisions in the young patient with sickle cell anemia are based upon steady state hemoglobin levels. Obtaining such data on patients in BABY HUG Clinical Centers could undermine blinding of treatment assignments. The Medical

Coordinating Center will provide the unblinded Primary Endpoint Person at each Clinical Center with a 3-month rolling average of steady state hemoglobin measurements monthly. Steady state is defined by intervals when the patient is not having a febrile, acute chest syndrome, aplastic crisis or splenic sequestration event. MCV and white cell or neutrophil counts will not be included with the information on hemoglobin level.

Spleen and Splenic Sequestration: Parents and caregivers should be instructed in techniques of spleen palpation at each clinical visit and asked to feel for the child's spleen daily. A newly palpable spleen or one more than 2 cm larger than previously noted should be reported immediately to the Clinical Center, and the patient should have a CBC and be examined by a physician or nurse practitioner knowledgeable about sickle cell anemia. The span of the spleen below the costal margin in the midclavicular and anterior axillary lines should be carefully measured and recorded (in centimeters) at each clinical visit. The management of splenic enlargement (admission, close outpatient follow-up or transfusion) will be at the discretion of the Principal Investigator at each Clinical Center, but the following guidelines should be used whenever appropriate/possible.

On initial evaluation:

1. Vital signs at presentation and q1-2 hours initially;
2. Careful physical examination with assessment of pallor, measurement of spleen size, presence of gallop, liver size; repeat examination q1-2 hours initially;
3. Labs including CBC, WBC differential, reticulocytes STAT. Type and crossmatch for packed red blood cells (PRBCs);
4. If hypovolemic or with cardiovascular compromise, emergent infusion of intravenous fluids (IVF) or PRBC to restore blood volume and maintain normal blood pressure. If normovolemic, start IVF at 1x maintenance.
5. Admission unless stable over 4-8 hour period; close follow-up.

On admission:

1. Monitor heart rate (HR), respiratory rate (RR), pulse oximetry q2 hours until stable, then q4h;
2. Repeat CBC studies q4-12 hours;
3. Maintain IVF at 1x maintenance;
4. If febrile obtain blood culture and begin antibiotics, e.g. cefuroxime 50 mg/kg IV every 8 hours;
5. Transfuse for evidence of hypotension, cardiovascular (CV) compromise, enlarging tender spleen with 10-15 cc/kg over 4 hours.

If no CV compromise, transfuse if Hgb <5 gm/dL for stable splenomegaly regardless of reticulocyte count; if Hgb > 5gm/dL transfuse at Principal Investigator discretion.

Goal of transfusion is Hgb about 8 gm/dL, (splenic unloading of trapped RBC may cause an "overshoot phenomenon");

6. Supplemental oxygen until condition is stable (or acute episode resolves);
7. Other clinical interventions, including antipyretics and analgesics, at Principal Investigator discretion.

After the initial splenic sequestration event, the child will be monitored every 2 weeks. The decision to continue PRBC transfusions and/or proceed to splenectomy, will be at the discretion of the Principal Investigator. However, the number of children undergoing splenectomy according to local indications will be tabulated in each treatment group. Chronic transfusion therapy or splenectomy, options that would remove the patient from study treatment or scintographic evaluation of the primary (spleen) endpoint, should be discussed with the Operations Committee prior to implementation.

Episodes of splenomegaly splenic sequestration and associated measures will be tabulated and compared according to HU and placebo group assignment. If an excess of severe sequestration events is found in the HU group, the DSMB will review and may consider stopping the trial.

Renal: Parents and caregivers will be educated about the importance of the kidneys in children with sickle cell disease, and reminded that the kidneys are special organs tested in the BABY HUG trial. Infants should remain adequately hydrated at all times, as dehydration is detrimental and could be injurious to the kidneys. Treatment that has potential risk to the kidneys, such as prolonged use of aminoglycosides or high-dose non-steroidal anti-inflammatory drugs, should be avoided. Frequent urinary tract infections and hematuria will be documented during the BABY HUG trial, as these findings may reflect or cause renal damage.

Painful Events (vaso-occlusive or dactylitis): Parents and caregivers will be educated about dactylitis and painful events as part of their education about sickle cell disease. They will be taught to push fluids and use ibuprofen and/or acetaminophen with codeine at home. Small supplies of both analgesics should be prescribed for home use at routine clinical visits. They and caregivers will be educated about dactylitis and painful events as part of their education about sickle cell disease. The definition of a painful event is an event lasting two hours or more without obvious cause requiring the use of one or more doses of non-steroidal or narcotic pain medication. Events treated as an outpatient (including emergency room) or requiring admission will be reported at the next Clinical Center contact and included in data entered. They will also be reported to the Medical Coordinating Center on Form 50 (Reportable Event and/or Hospitalization) and supporting documents collected for central review.

Acute Chest Syndrome, Aplastic Crisis, Priapism: All events meeting defined criteria will be reported to the Medical Coordinating Center on event report forms (Form 50: Reportable Event and/or Hospitalization). Clinical management, including the need for simple or exchange



transfusion will be at the option of each Clinical Center. Chronic transfusion therapy, which would remove the patient from study treatment, should be discussed with the Operations Committee prior to implementation.

Parents will be educated about signs of acute chest syndrome (fever, respiratory symptoms and aplastic crisis (pallor, decreased energy) at regular clinic visits and asked to seek medical attention should they occur. Parents of male children will be taught about priapism, a prolonged painful erection of the penis, and asked to seek medical attention, if the episode persists beyond two hours. Briefer episodes of priapism will be recorded at the next clinic visit.

Neurologic Events: Families will be taught standardized definitions of TIA, stroke and other neurologic events and reminded at each clinical contact to call the Clinical Center immediately if the child is not able to move arms or legs (unrelated to pain), has facial drooping or dysarthria. Each Clinical Center will promptly evaluate such patients. The minimum evaluation must include documentation of complete neurologic examination, preferably by a neurologist. If the neurologist suspects stroke or TIA clinically, neuroimaging including MRI/MRA must be done. If a stroke is confirmed, acute management will be at the preference of the Clinical Center. Transfusion timing and technique (exchange or simple) will be at Clinical Center preference. Chronic transfusion therapy, an option that would remove the patient from study treatment, should be discussed with the Operations Committee prior to implementation.

If transcranial Doppler (TCD) screening is part of an individual Clinical Center's standard care, such testing should be offered to patients enrolled in BABY HUG as per usual practice. TCD screening is not yet universally available or standardized for children less than two years of age. If screening is performed and values are persistently abnormally elevated in children over 2 years of age, the parents should be offered chronic transfusion therapy for the child in accordance with standard practice at each Clinical Center. Patients for whom chronic transfusion therapy is considered should be discussed in advance with the Operations Committee.